

PC4

Musician's Guide

Including ***PC4-7***

KURZWEIL®

It's the **sound.**®

FLASH  **PLAY™**

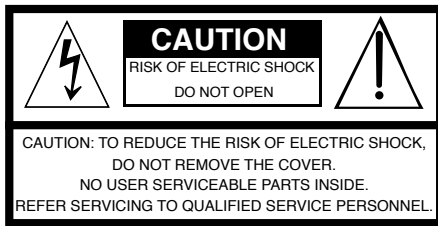

The lightning flash with the arrowhead symbol, within an equilateral triangle is intended to alert the user to the presence of uninsulated "dangerous voltage" within the product's enclosure that may be of sufficient magnitude to constitute a risk of electric shock to persons.



The exclamation point within an equilateral triangle is intended to alert the user to the presence of important operating and maintenance (servicing) instructions in the literature accompanying the product.

IMPORTANT SAFETY & INSTALLATION INSTRUCTIONS

INSTRUCTIONS PERTAINING TO THE RISK OF FIRE ELECTRIC SHOCK , OR INJURY TO PERSONS

WARNING: When using electric products, basic precautions should always be followed, including the following:

1. Read all the Safety and Installation Instructions and Explanation of Graphic Symbols before using the product.
2. This product must be grounded. If it should malfunction or break down, grounding provides a path of least resistance for electric current to reduce the risk of electric shock. This product is equipped with a power supply cord having an equipment-grounding conductor and a grounding plug. The plug must be plugged into an appropriate outlet which is properly installed and grounded in accordance with all local codes and ordinances.

DANGER: Improper connection of the equipment-grounding conductor can result in a risk of electric shock. Do not modify the plug provided with the product – if it will not fit the outlet, have a proper outlet installed by a qualified electrician. Do not use an adaptor which defeats the function of the equipment-grounding conductor. If you are in doubt as to whether the product is properly grounded, check with a qualified serviceman or electrician.
3. Do not use this product near water – for example, near a bathtub, washbowl, kitchen sink, in a wet basement, or near a swimming pool, or the like.
4. This product should only be used with a stand or cart that is recommended by the manufacturer.
5. This product, either alone or in combination with an amplifier and speakers or headphones, may be capable of producing sound levels that could cause permanent hearing loss. Do not operate for a long period of time at a high volume level or a level that is uncomfortable. If you experience any hearing loss or ringing in the ears, you should consult an audiologist.
6. This product should be located so that its location or position does not interfere with its proper ventilation.
7. The product should be located away from heat sources such as radiators, heat registers, or other products that produce heat.
8. The product should be connected to a power supply only of the type described in the operating instructions or as marked on the product.
9. This product may be equipped with a polarized line plug (one blade wider than the other). This is a safety feature. If you are unable to insert the plug into the outlet, contact an electrician to replace your obsolete outlet. Do not defeat the safety purpose of the plug.
10. The power supply cord of the product should be unplugged from the outlet when left unused for a long period of time. When unplugging the power supply cord, do not pull on the cord, but grasp it by the plug.
11. Care should be taken so that objects do not fall and liquids are not spilled into the enclosure through openings.
12. The product should be serviced by qualified service personnel when:
 - A. The power supply cord or the plug has been damaged;
 - B. Objects have fallen, or liquid has been spilled into the product;
 - C. The product has been exposed to rain;
 - D. The product does not appear to be operating normally or exhibits a marked change in performance;
 - E. The product has been dropped, or the enclosure damaged.
13. Do not attempt to service the product beyond that described in the user maintenance instructions. All other servicing should be referred to qualified service personnel.
14. **WARNING:** Do not place objects on the product's power supply cord, or place the product in a position where anyone could trip over, walk on, or roll anything over cords of any type. Do not allow the product to rest on or be installed over cords of any type. Improper installations of this type create the possibility of a fire hazard and/or personal injury.

RADIO AND TELEVISION INTERFERENCE

WARNING: Changes or modifications to the instrument not expressly approved by HDC-Young Chang could void your authority to operate the instrument.

IMPORTANT: When connecting this product to accessories and/or other equipment use only high quality shielded cables.

NOTE: This instrument has been tested and found to comply with the limits for a Class B digital device, pursuant to Part 15 of the FCC Rules. These limits are designed to provide reasonable protection against harmful interference in a residential installation. This instrument generates, uses, and can radiate radio frequency energy and, if not installed and used in accordance with the instructions, may cause harmful interference to radio communications. However, there is no guarantee that interference will not occur in a particular installation. If this instrument does cause harmful interference to radio or television reception, which can be determined by turning the instrument off and on, the user is encouraged to try to correct the interference by one or more of the following measures:

- Reorient or relocate the receiving antenna.

- Increase the separation between the instrument and the receiver.
- Connect the instrument into an outlet on a circuit other than the one to which the receiver is connected.
- If necessary consult your dealer or an experienced radio/television technician for additional suggestions.

The normal function of the product may be disturbed by strong electromagnetic interference. If so, simply reset the product to resume normal operation by following the instructions in the manual. If normal function does not resume, please use the product in another location.

NOTICE

This apparatus does not exceed the Class B limits for radio noise emissions from digital apparatus set out in the Radio Interference Regulations of the Canadian Department of Communications.

AVIS

Le présent appareil numérique n'émet pas de bruits radioélectriques dépassant les limites applicables aux appareils numériques de la class B prescrites dans le Règlement sur le brouillage radioélectrique édicté par le ministère des Communications du Canada.

SAVE THESE INSTRUCTIONS

IMPORTANT SAFETY INSTRUCTIONS

- 1) Read these instructions.
- 2) Keep these instructions.
- 3) Heed all warnings.
- 4) Follow all instructions.
- 5) Do not use this apparatus near water.
- 6) Clean only with dry cloth.
- 7) Do not block any of the ventilation openings. Install in accordance with the manufacturer's instructions.
- 8) Do not install near any heat sources such as radiators, heat registers, stoves, or other apparatus (including amplifiers) that produce heat.
- 9) Do not defeat the safety purpose of the polarized or grounding-type plug. A polarized plug has two blades with one wider than the other. A grounding type plug has two blades and a third grounding prong. The wide blade or the third prong are provided for your safety. If the provided plug does not fit into your outlet, consult an electrician for replacement of the obsolete outlet
- 10) Protect the power cord from being walked on or pinched, particularly at plugs, convenience receptacles, and the point where they exit from the apparatus.



- 11) Only use attachments/accessories specified by the manufacturer.
- 12) Use only with a cart, stand, tripod, bracket, or table specified by the manufacturer, or sold with the apparatus. When a cart is used, use caution when moving the cart/apparatus combination to avoid injury from tip-over.
- 13) Unplug this apparatus during lightning storms or when unused for long periods of time.

- 14) Refer all servicing to qualified service personnel. Servicing is required when the apparatus has been damaged in any way, such as power-supply cord or plug is damaged, liquid has been spilled or objects have fallen into the apparatus, the apparatus has been exposed to rain or moisture, does not operate normally, or has been dropped.

Warning: To reduce the risk of fire or electric shock, do not expose this apparatus to rain or moisture. Do not expose this equipment to dripping or splashing and ensure that no objects filled with liquids, such as vases, are placed on the equipment.

To completely disconnect this equipment from the AC Mains, disconnect the power supply cord plug from the AC receptacle.

PROP 65 WARNING:

This product contains chemicals known to the State of California to cause cancer, or birth defects or other reproductive harm.

As with most electronic equipment, the outer cables may contain phthalate and the copper alloy power plug contains lead. Wash hands after handling.

©2019 HDC-Young Chang Co., Ltd. All rights reserved. Kurzweil® is a product line of HDC-Young Chang Co., Ltd. Kurzweil®, HDC-Young Chang®, V. A. S. T.®, PC4® and FlashPlay™ are trademarks of HDC-Young Chang Co., Ltd. All other trademarks and copyrights are property of their respective companies. Product features and specifications are subject to change without notice.

U.S. Patents 6,806,413, 6,978,288, 8,263,849

You may legally print up to two (2) copies of this document for personal use. Commercial use of any copies of this document is prohibited. HDC-Young Chang Co. retains ownership of all intellectual property represented by this document.

Kurzweil International Contacts

Contact the Kurzweil office listed below to locate your local Kurzweil representative.

US Customers:

American Music & Sound
925 Broadbeck Dr #220
Newbury Park, CA 91320

Tel: 800-431-2609

Fax: 818-597-0411

Email: info@americanmusicandsound.com

Customers outside the US:

HDC YOUNG CHANG
196, Bongsu-daero, Seo-gu
Incheon, Korea Post Code: 22840

Tel: +82-32-570-1570

Fax: +82-32-576-2340



www.kurzweil.com



support@kurzweil.com



www.facebook.com/kurzweilmusicsystems/



www.twitter.com/KurzweilMusic



www.youtube.com/user/KurzweilTutorials

Table of Contents

Kurzweil International Contacts.....	iv
Getting Started	1-1
Features.....	1-1
Software Updates	1-2
Quick Start	1-3
The Front Panel	1-5
The Rear Panel.....	1-8
PC4 Sounds	1-12
Modes	1-14
Double Button Presses	1-16
Program Mode	2-1
Selecting Programs.....	2-1
Program Demo.....	2-2
The Display	2-3
Controllers	2-5
The Split and Layer Soft Buttons.....	2-6
Changing the MIDI Channel.....	2-9
Panic.....	2-9
Save User Programs	2-10
Program Edit Mode	3-1
Program Types.....	3-1
Editing VAST Programs	3-2
Navigation	3-4
The PARAMS Page	3-6
The FX Page.....	3-13
The Layer FX (LYR FX) Page	3-16
The COMMON Page	3-17
The Arpeggiator (ARP) Page	3-22

The CC Sequencer (CC SEQ) Page.....	3-35
The KEYMAP Page	3-40
The LAYER Page.....	3-45
The Wiring Algorithm (ALG) Page.....	3-50
The DSP Control (DSP CTL) Page.....	3-54
The DSP Modulation (DSP MOD) Page.....	3-56
The OUTPUT Page.....	3-58
The Amplitude Envelope (AMP ENV) Page	3-61
The Envelope 2 (ENV2) and Envelope 3 (ENV3) Pages.....	3-66
The LFO+ Page	3-67
The Soft Button Functions	3-71
The Mode Button Functions	3-73
Editing VAST Programs With KVA Oscillators.....	3-74
Editing FM Layers.....	3-82
FM MAIN Page.....	3-83
FM Operator Page.....	3-86
FM Layer Page	3-91
FM Amp + Output Page	3-97
FM Alt Input Page	3-99
FM Operator Mute Page	3-106
Editing KB3 Programs	3-107
KB3 Editor: Navigation	3-109
KB3 Editor: The Parameters (PARAMS) Page	3-109
KB3 Editor: The Program FX (FX) Page	3-109
KB3 Editor: The COMMON Page	3-109
KB3 Editor: The Drawbars (DRAWBAR) Page	3-111
KB3 Editor: The Tone Wheels (TONEWL) Page.....	3-112
KB3 Editor: The PITCH Page	3-114
KB3 Editor: The AMP Page	3-114
KB3 Editor: The EQ Page.....	3-115
KB3 Editor: The PERC Page.....	3-115
KB3 Editor: The KEYCLICK Page	3-117

KB3 Editor: The LFO+, ARP and CC SEQ Pages.....	3-119
The Effects Chain Editor	4-1
The MAIN Page	4-2
The MOD Pages	4-3
FXLFO+ page	4-5
INFO page.....	4-6
The Chain Utility Soft Buttons.....	4-7
Effects Parameters	4-9
Keymap and Sample Editing.....	5-1
The Keymap Editor.....	5-1
Building a Keymap	5-8
Editing Samples.....	5-10
Multi Mode	6-1
Selecting Multis	6-1
The Display	6-2
Controllers	6-3
The Split and Layer Soft Buttons.....	6-6
Save User Multis.....	6-9
Recording A Multi To Song Mode	6-11
Multi Edit Mode.....	7-1
Navigation	7-1
OVERVIEW Page.....	7-3
MAIN Page.....	7-5
CONTROLS Page.....	7-13
FX Page	7-27
ARP Page	7-29
CC Sequencer (CC SEQ) Page	7-30
RIFF Page	7-31
COMMON Page	7-40
Audio In FX (AUDIO IN) Page	7-41

The Soft Button Functions	7-42
The Mode Button Functions	7-43
Song Mode	8-1
The TRANSPORT Section	8-2
The Save Changes Dialog	8-3
The MAIN Page	8-5
The MIXER Page	8-14
The MISC Page	8-17
Soft Button Functions	8-19
The FILTER Page	8-20
The FX Page	8-22
The TRACK Page	8-23
The EVENT Page	8-36
Global Mode	9-1
About Global Mode	9-1
MAIN 1 Page	9-1
MAIN 2 Page	9-9
FX (Master FX Page)	9-16
FILE (Storage Page)	9-17
MIDI Page	9-23
OBJECTS Page	9-27
SAMPLES	9-28
MIXER	9-29
TEMPO	9-30
INFO	9-31
TOOLS Page	9-31
RESET Page	9-33
Troubleshooting	10-1
Maintenance	10-1
Common Problems	10-1
MIDI Problems	10-5

Pedal Problems.....	6
Other Problems.....	6
MIDI Implementation	A-1
Specifications.....	B-1
Programs	C-1
Multis.....	D-1
Index.....	I-1

Chapter 1

Getting Started

This chapter will give you a quick overview of the PC4.

Features

Sounds

- FlashPlay technology utilizing 2GB of instrument samples including:
 - Optimized German D and Japanese C7 Pianos, Triple Strike Piano, 73 Electric Piano, Clavinets, Harpsichords, Celeste, Bowed and Hit Crotales, Vector Synthesis Waveforms
 - Updated Rock, Synth and Orchestral sounds from Kurzweil's SP6, PC3, and KORE64
 - 13 Categories of Programs (Piano, E. Piano, Clav, Organ, Strings, Pad, Synth, Brass/Wind, Ensemble, Hybrid, Guitar/Bass, Drum/Perc, Misc)
- 2GB of user sample memory for loading samples from WAV, AIF, P3K, and K series files
- KB3 ToneReal™ organ simulations with 9 sliders as drawbars
- KSR: Kurzweil String Resonance (piano string resonance simulation)
- FM: Classic 6 operator FM synthesis
- Half-Damper pedal support (for piano "half pedaling" sustain techniques)
- Kurzweil's highly acclaimed VAST Synthesis and FX engine
- More than 1000 Factory Programs divided into 13 Categories
- More than 50 Factory Multis
- More than 4000 User IDs to save your own Programs and Multis
- Audio input jacks with FX (one 1/8" stereo line-in and 1/4" stereo line-in pair)
- 256 voices of polyphony
- 16 Zone MIDI controller in Multi Mode for Splits and Layers
- 16 MIDI Tracks in Song Mode
- Arpeggiator with dedicated front panel controls (up to 16 simultaneous in Multi Mode)

Keyboard and Controllers

The PC4 has an 88-key fully-weighted hammer action keyboard that provides you with a piano-like feel. The PC4-7 has a 76-key semi-weighted action keyboard. The array of physical controllers includes:

- 9 assignable sliders
- 9 assignable knobs
- 10 assignable switch buttons
- Pitch Wheel and assignable Modulation Wheel
- Tap tempo button and tempo knob
- 2 Transpose buttons
- Monopressure (Aftertouch)
- 2 assignable switch pedal jacks (supports up to 4 switch pedals with 2 pedals per jack)
- 2 assignable CC pedal jacks
- Assignable ribbon controller jack

Pedals (Optional)

The PC4 has four jacks on the rear panel for optional pedal controllers.

Two switch pedal jacks are typically used to control two-state (i.e., on / off) parameters such as sustain, sostenuto, and soft pedal. A Half Damper pedal (also known as a continuous switch pedal) can be used to allow for “half pedaling” sustain techniques when playing PC4 piano programs. Each jack also supports dual switch pedals, allowing up to 4 switch pedals to be used.

Two continuous control (or CC) pedal jacks are typically used to control continuous parameters such as volume and wah.

Your Kurzweil dealer stocks the following pedals:

- KP-1 Single piano-style switch pedal
- KP-1H Single piano-style Half Damper pedal
- CC-1 Continuous pedal

Software Updates

Be sure to check the Kurzweil website at www.kurzweil.com for new sounds, documentation and software updates. See the Info page in Global mode to check the currently installed OS version.

Quick Start

Setting Up the PC4

1. If your PC4 has been out in the cold during shipping, give it time to warm up to room temperature before powering it on, since condensation may have formed inside.
2. Place the PC4 on a keyboard stand or on a hard, flat, level surface.
3. Connect the DC power adaptor to the PC4 DC Power jack.
4. Make sure your power outlet is compatible with the included power adaptor, then plug the power cable into the power outlet.
5. Plug the included Switch Pedal into the SW1 (SUSTAIN) jack on the PC4 rear panel.
6. If you have an additional switch pedal, plug it into the SW2 jack for Sostenuuto control.
7. If you have a MIDI CC pedal (also known as a MIDI expression or volume pedal), plug it into the CC1 (VOLUME) jack for volume control.
8. If you are using speakers, turn the master volume all the way down on your amplifier or mixer. Using standard (1/4-inch) audio cables, first plug into the input jacks of your amplifier or mixer, then plug the other end of the cables into the PC4 AUDIO OUT A jacks. (Connecting in this order minimizes the possibility of static discharge damage.) For a mono signal, only use the LEFT (MONO) A jack, and leave the RIGHT A jack unplugged. Balanced (“TRS” or “Stereo”) cables are recommended if your mixer or amp supports balanced inputs.
9. If you are using headphones, connect stereo headphones to the headphone jack on the rear panel.
10. Move the PC4 VOLUME slider (on the far left side of the front panel) to the minimum (closer to the keys).

Powering On the PC4

1. Power on the PC4 by pressing the POWER button on the right rear panel.
2. If you are using speakers, turn up the volume on your amplifier or mixer.
3. Slowly turn up the PC4 VOLUME Slider and play some notes to check the volume level. (If you have a CC pedal plugged into the CC (VOLUME) jack, make sure it is set to the maximum volume position).
4. If you are using speakers and the PC4 is not loud enough, turn up the volume on your amplifier or mixer.
5. If you are using a mixer and hear distortion, reduce the gain level on the mixer, or use the mixer's Pad button if it has one (a button that typically decreases the audio input level by 20dB).
6. After using the PC4, if you are using speakers, turn the master volume all the way down on your amplifier or mixer before powering off the PC4.

Auditioning PC4 Sounds

1. The PC4 starts up in Program Mode. Use the PREVIOUS and NEXT buttons, Alpha Wheel, or CATEGORY buttons to select a different Program. See [PC4 Sounds on page 1-12](#) for more details on selecting Programs or Multis.
1. To hear a Program Demo song for the current Program, press the 0/MISC and ENTER buttons simultaneously.
2. To hear the capabilities of the PC4, you can play the multi-channel demo songs. Press the USER and 0/MISC buttons simultaneously to listen to a multi-channel demo song.
3. To switch between auditioning Programs or Multis, press the PROGRAM or MULTI Mode button under the MODE label to the right of the display.

Automatic Power Saving

The PC4 has an automatic power saving feature (Auto Power Off) that can automatically power off the PC4 after a period of inactivity, in order to conserve electricity. The Auto Power Off feature is enabled by default. The default Power Off Time is 8 hours, which will cause the PC4 to power off after 8 hours of inactivity.

A count down timer warning will be shown in the display a few minutes before the PC4 is powered off. At any time, touching any PC4 control or playing a note will cause the PC4 to remain powered on, until the PC4 has been inactive for the set Power Off Time.

Auto Power Off can be disabled in Global Mode. The Power Off Time can also be adjusted in Global Mode.

The Front Panel

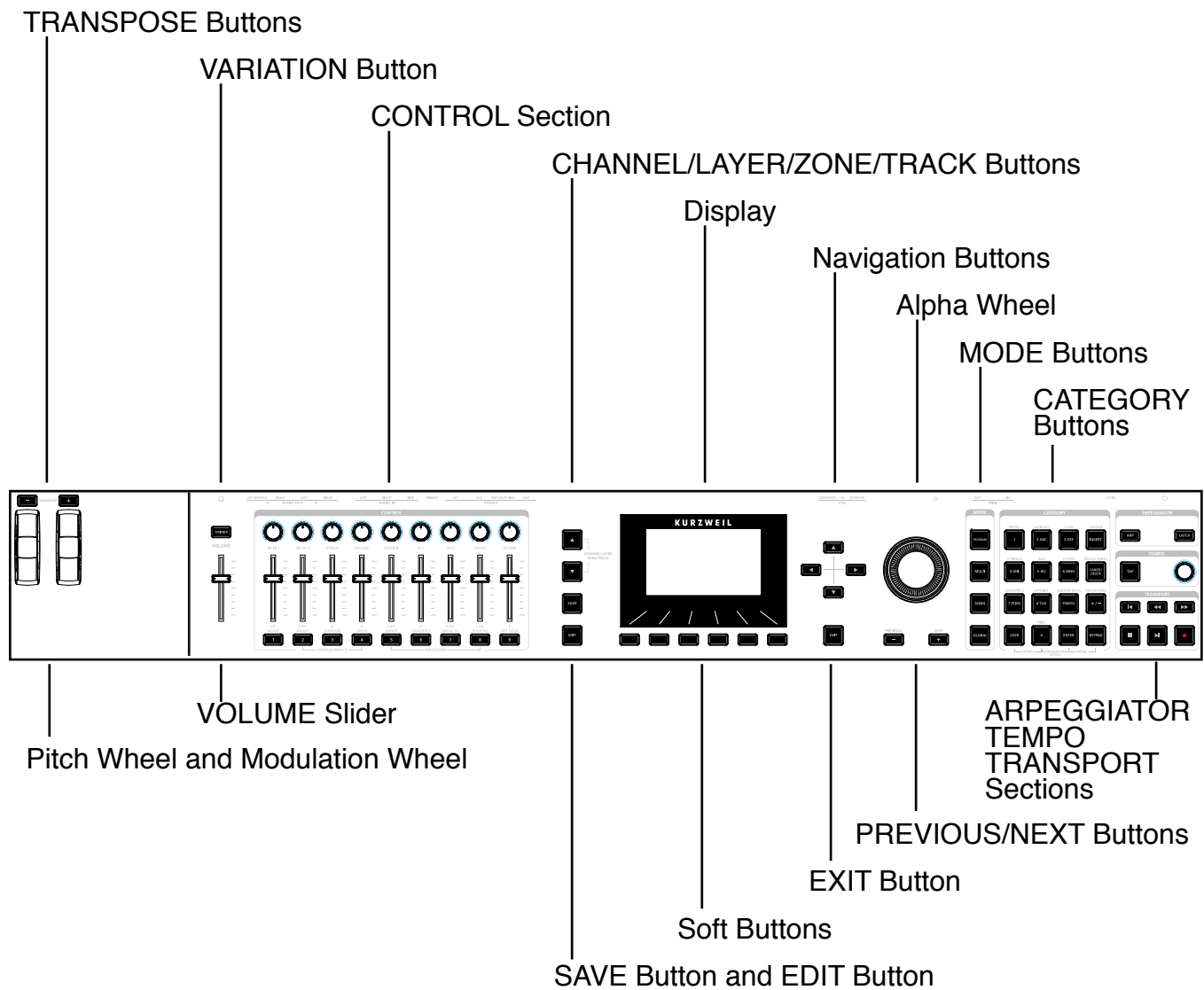

VOLUME Slider

The VOLUME Slider controls the volume level of the AUDIO OUT and HEADPHONE jacks.

Display

The display is the main user interface for the PC4. Use the display to view Program and Multi names, controller assignments, and editing functions.

Soft Buttons

The 6 buttons below the display are called soft buttons. Soft buttons change their functions depending upon which page is being displayed. The functions of the soft buttons on each page are described in the bottom row of the display.

Navigation Buttons

The Navigation buttons move the cursor in the display and allow you to select the current parameter to be edited.

Alpha Wheel

In Program and Multi Mode, use the Alpha Wheel to navigate through the Program or Multi list.

In Program Edit or Multi Edit Mode, use the Alpha Wheel to scroll through the list of values for the currently selected parameter. Turn the Alpha Wheel counter-clockwise or clockwise to select the previous or next value. Turn the Alpha Wheel slowly to change the value by one increment, or turn it quickly to jump several increments.

PREVIOUS and NEXT Buttons

In Program and Multi Mode, use the PREVIOUS and NEXT buttons to navigate through the Program or Multi list. In any mode, use the PREVIOUS and NEXT buttons to navigate through the list of values for the currently selected parameter.

MODE Buttons

Press the MODE buttons to access PROGRAM, MULTI, SONG or GLOBAL Mode. See [Modes on page 1-14](#) for a description of each Mode.

CATEGORY Buttons

In Program Mode, the CATEGORY buttons allow you to select and browse Programs in 13 categories of instruments. Engaging the KEYPAD button allows you to use the CATEGORY buttons as an alphanumeric keypad. The KEYPAD button is always on in Multi Mode, and where needed for editing parameter values.

TRANSCOPE Buttons

The TRANSCOPE buttons can be used to change the tuning of notes played on the PC4 keyboard in semitones (also known as half steps). The current transpose amount is shown in the top line of the display. Press both TRANSCOPE buttons simultaneously to reset the transposition to 0.

Pitch Wheel and Modulation Wheel

Use each wheel to respectively perform pitch bends or vary the modulation amount. The Modulation Wheel will control modulation for each Program or Multi. The name of the current modulation assignment is shown in the display when the wheel is moved.

VARIATION Button

Pressing the VARIATION button will perform an assigned variation for each Program or Multi. The name of the current assignment is shown in the display when the button is pressed.

The VARIATION button has two states, off (not lit) and on (lit). The VARIATION button will typically modify the sound by adding an orchestral string section or synth pad layer, or enabling an effect.

For KB3 Organ Programs, the VARIATION button controls the Rotary Speaker speed, changing between fast and slow. The display shows “KB3” when a KB3 Program is selected.

CONTROL Section

The CONTROL section is used to control various Program and Multi parameters.

In Program Mode: The knobs, sliders, and buttons control synthesis and FX parameters for the current Program. Controller assignments can be adjusted or set to user-assignable parameters in Program Edit Mode.

In Multi Mode: The knobs, sliders, and buttons typically control Zone volume, synthesis and FX parameters for the current Multi. Controller assignments can be adjusted or set to user-assignable parameters in Multi Edit Mode.

In Program and Multi Mode: When a KB3 Organ Program is selected, some of the knobs, sliders, and buttons may perform Organ functions labeled on the front panel. The display shows “KB3” when a KB3 Program is selected.

ARPEGGIATOR Section

Use the ARP and LATCH buttons to control the PC4's Arpeggiator.

Getting Started

The Rear Panel

TEMPO Section

Use the TEMPO section to set the tempo of the Arpeggiator, the rate of tempo synced FX (such as Delay), or the tempo of the current Multi or Song. To set the tempo press the TAP button a few times at the desired rate, or use the TEMPO knob.

TRANSPORT Section

Use the buttons in the TRANSPORT section to control recording and playback in Song mode.

SAVE Button and EDIT Button

These buttons are used when editing Programs, Multis, or other User objects. In Program Mode, press the SAVE button to save a User Program with the current controller settings.

EXIT Button

Press the EXIT button to exit the current editor. Press the EXIT button repeatedly to return to Program Mode.

CHANNEL/LAYER/ZONE/TRACK Buttons

Use the CHANNEL/LAYER/ZONE/TRACK buttons to change the current MIDI Channel in Program Mode, the current Layer in Program Edit Mode, the current Zone in Multi Edit Mode, or the current Track in Song Mode.

The Rear Panel

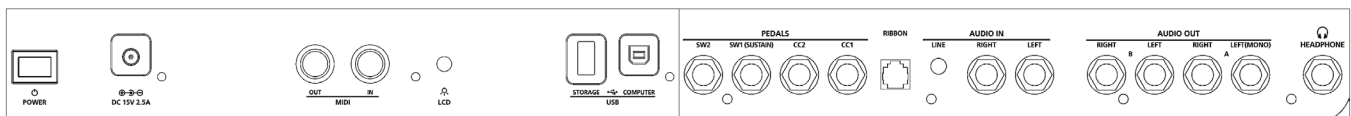

POWER Button

Press the POWER button to power the PC4 on or off.

DC Power Jack

Plug the included power adaptor into the DC Power jack.

MIDI IN and OUT Ports

Use the MIDI ports to communicate with other MIDI modules and controllers. The OUT port is the MIDI transmitting port, and the IN port is the MIDI receiving port.

To use the PC4 as a MIDI controller for another sound module, use a MIDI cable to connect the PC4's MIDI OUT port to the MIDI input port of the module that you want to control.

To control the PC4 using another MIDI controller, use a MIDI cable to connect the PC4's MIDI IN port to the MIDI output port of the controller that you will be using.

LCD Knob

Use the LCD knob to control the display brightness.

USB Ports

Use the USB ports to connect the PC4 to a computer/tablet or USB hard drive in order to do the following:

- Use the PC4 as a MIDI controller to play software instruments on a computer/tablet.
- Use a computer/tablet to sequence multi-channel songs on the PC4.
- Backup and restore User objects with a USB hard drive.
- Update the software and sounds of the PC4 with a USB hard drive.

SW1 (SUSTAIN) and SW2 Jacks

Use the SW1 (SUSTAIN) and SW2 jacks to connect switch pedals. One switch pedal is included with the PC4.

In Program Mode, SW1 (SUSTAIN) defaults to controlling Sustain, and SW2 defaults to controlling Sostenuto. (For KB3 Organ Programs, SW1 (SUSTAIN) defaults to controlling the Rotary Speaker speed, changing between fast and slow. This assignment can be changed in Global Mode. The LCD display shows “KB3” when a KB3 Program is selected.)

In Multi Mode, pedal assignments can vary per Multi. Pedal assignments can be adjusted for each Zone by using Multi Edit Mode.

Global Mode can be used to set pedal overrides, which can change the pedal assignments for all Programs and Multis.



Note: Switch pedals must be plugged in before powering on the PC4. Do not to step on the switch pedals when powering on the PC4, as the state of the pedals is detected as part of the start up sequence.

Getting Started

The Rear Panel

Dual Switch Pedals

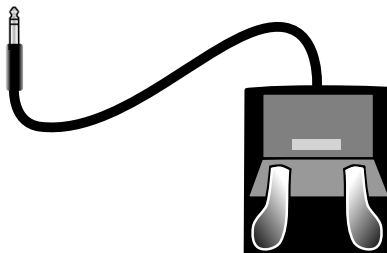

The SW1 (SUSTAIN) and SW2 jacks can be connected to dual switch pedals (2 pedals per jack), allowing up to four switch pedals to be used. Compatible pedals should use a single 1/4 inch tip-ring-sleeve plug.

Pedals plugged into the SW1 (SUSTAIN) jack are referred to as SW1a and SW1b, and pedals plugged into the SW2 jack are referred to as SW2a and SW2b. In Program Mode the default assignments are:

SW1a	Sustain
SW1b	Sostenuto
SW2a	Sostenuto
SW2b	Soft Pedal

To emulate the 3 pedals of an acoustic piano, plug a single switch pedal into the SW1 (SUSTAIN) jack, and a dual switch pedal into the SW2 jack.

Continuous Switch Pedals (Half-Damper)

The SW1 (SUSTAIN) jack is also compatible with continuous switch pedals (Half-Damper) that use a 1/4 inch tip-ring-sleeve plug (such as the Kurzweil KP-1H). When connected to the SW1 (SUSTAIN) jack, a Half Damper pedal enables finer control of Sustain than a standard switch pedal. Half Damper control is enabled for Programs in the Piano category. Programs outside of the Piano category will respond to a Half Damper pedal as if it is a standard switch pedal.

CC1 (VOLUME) and CC2 Jacks

Use the CC1 (VOLUME) jack to connect a MIDI CC pedal (also known as a MIDI expression or volume pedal). By default this pedal is assigned to control Program and Multi volume (pre-FX).

For KB3 Organ Programs, the CC1 (VOLUME) pedal controls organ swell. Organ swell is similar to Program volume, except volume can not be turned all the way down to silence. The LCD display shows “KB3” when a KB3 Program is selected.

For User Programs and Multis, the CC1 (VOLUME) and CC2 pedals can be assigned to different functions by using Program Edit or Multi Edit Mode.

The optional Kurzweil CC-1 continuous control pedal will work best with the PC4, but it is also possible to use third-party continuous control pedals designed for keyboards. Compatible pedals should use a 10 k Ω linear-taper potentiometer, with a 1/4 inch tip-ring-sleeve (stereo) plug with the wiper connected to the tip.

RIBBON Jack

Use the RIBBON jack to plug in the optional Kurzweil Ribbon Controller. By default the ribbon controls pitch bend, but you can also program the ribbon controller to send other MIDI messages. To use the ribbon controller, just press it, and slide your finger along the ribbon to change the value of the message it's sending.

You can configure the ribbon to have one control section that runs its entire length, or to have three sections of equal length. It sends its highest values when you press it at the end where the cable connects. When you configure it to have three sections, each section sends its highest values at the end closest to the cable.



Caution: The modular jack is designed for connection to the Kurzweil Ribbon Controller option only. Don't plug any other modular plugs into the Ribbon jack.

AUDIO IN LINE/LEFT/RIGHT Jacks

Use the AUDIO IN jacks to mix external audio sources with the sounds of the PC4. This is useful for playing along with backing tracks from a portable music player, computer, or other electronic instrument. The LINE jack accepts a stereo 1/8" plug at line level, suitable for input from MP3 players and computers. The LEFT and RIGHT jacks each accept a 1/4" plug at line level, suitable for input from mixers and electronic instruments. Sources that are not line level (typically guitars and microphones) should be amplified with a pre-amp, mixer, audio interface or other device. Input volume and FX can be adjusted in Global Mode.

AUDIO OUT LEFT (MONO) and RIGHT A/B Jacks

Use the AUDIO OUT A/B jacks to connect to an amplifier or mixer. See [Quick Start on page 1-3](#) for details.

HEADPHONE Jack

Use the HEADPHONE jack located on the left rear panel of the instrument to listen to the PC4 on stereo headphones. You will need a 1/8-inch-to-1/4-inch adapter in order to use headphones that have a smaller mini plug connector.

When headphones are plugged in, audio is still transmitted from the AUDIO OUT jacks.

PC4 Sounds

The PC4 contains Programs and Multis. A Program is typically a single instrument sound such as a Piano, Organ, or Synth. Programs are organized by instrument type in 13 categories.

A Multi is a combination of Programs arranged as layers and/or splits across the keyboard. Multis are not categorized by instrument type, so the KEYPAD button is always on when in Multi Mode.

Selecting Programs

In Program Mode, use any of the methods below to select a Program.

Browse All Programs

Make sure the USER button is off, then use the Alpha Wheel or PREVIOUS and NEXT buttons to select a Program from all of the available Programs.

Select a Program by Category

Make sure the KEYPAD button is off, then press one of the CATEGORY buttons to select the first Program of a category (or the current Category Default Program). The selected CATEGORY button will turn on. Use the Alpha Wheel or PREVIOUS and NEXT buttons to select Programs from the selected category.

Select a Previously Saved User Program

Press and turn on the USER button, then use the Alpha Wheel or PREVIOUS and NEXT buttons to browse only User Programs. To return to browsing Factory and User Programs, press and turn off the USER button.

Select a Program by ID Number

Press and turn on the KEYPAD button. The keypad button allows you to use the numbers labeled on the CATEGORY buttons to select Programs or Multis by ID number. Type an ID number followed by pressing the ENTER button to select the associated Program.

Select a Category Default Program

Each category has a Category Default Program (the Program which is selected when each CATEGORY button is pressed). By default the Category Default Program is set to the first Program of each category. To set a different Category Default Program, select a Program, make sure the KEYPAD button is off, then press and hold the currently lit CATEGORY button.

Selecting Multis

In Multi Mode, use any of the methods below to select a Multi.

Browse All Multis

Make sure the USER button is off, then use the Alpha Wheel or PREVIOUS and NEXT buttons to select a Multi from all of the available Multis.

Select a Multi by ID Number

Use the CATEGORY buttons to type an ID number followed by pressing the ENTER button.

Select a Previously Saved User Multi

Press and turn on the USER button, then use the Alpha Wheel or PREVIOUS and NEXT buttons to browse only User Multis. To return to browsing Factory and User Multis, press and turn off the USER button.

VIEW Soft Button and Quick Access View

In Program or Multi Mode, press the VIEW soft button to switch between the default Large view, List view, and Quick Access view.

Quick Access view shows the names of 10 favorite Programs and/or Multis, which can be selected by pressing the corresponding numbers on the Keypad. To access more than 10 Programs/Multis, use the CHANNEL/LAYER/ZONE/TRACK buttons to select a different Quick Access Bank. Programs or Multis which are not stored in a Quick Access Bank can be browsed by using the ALPHA WHEEL or PREVIOUS/NEXT buttons.

When Quick Access view is selected, press and hold one of the Keypad buttons (0 through 9) to store the currently selected Program or Multi to a spot in the current Quick Access Bank. For details on Quick Access view, see [“Display” on page 9-3](#).

Controllers

The Sliders, Knobs, Buttons, Wheels, and Pedals can control each of the Factory Programs and Multis, to produce variations to the sound. Don't forget to try these out as you explore the Factory sounds on the PC4.

Generally, each control will perform the assignment labeled on the front panel, although some controls may have different assignments per Program or Multi. When a controller is moved, the name of the current assignment is shown in the display. Controller assignments can be adjusted in Program and Multi Edit Mode.

Splits and Layers

The Split and Layer function can be used to Split or Layer the current Program or Multi. Different keyboard regions can play different Programs, or multiple Programs can be played from the same region. To Split or Layer a Multi, it must contain at least one Zone which is unused (Off).

In Program or Multi Mode, press the SPLIT or LAYER soft button to view the Split or Layer Page. You will then be able to configure up to three additional Programs to create a Split or Layered Multi containing up to four Programs.

Press the SAVE button once to view the Save Dialog. The Save Dialog allows you to choose an ID number and name for the Split/Layer Multi you are saving. On the Multi Save Page, press the SAVE button again to save the Split/Layer Multi. After saving the Split or Layer as a Multi, additional Multi Controller and FX settings can be edited in Multi Edit Mode.

Modes

Program Mode

The PC4 always powers up in Program Mode, where single instrument sounds can be played directly from the keyboard, or multitimbrally via MIDI.

Saving Programs

If you make changes to the current Program using any of the controllers (Knobs, Wheels or Buttons), the SAVE button turns on to indicate that a change has been made to that Program.

To save a copy of the Program with the changes you've made, press the SAVE button once to view the Save Dialog. The Save Dialog allows you to choose an ID number and name for the Program you are saving. On the Program Save Page, press the SAVE button again to save the Program as a User Program.

Program Edit Mode

Program Edit Mode allows you to select parameters for the assignable knobs, sliders and buttons, adjust the current Program's Arpeggiator settings, and adjust many other Program parameters.

Multi Mode

Multi Mode allows you to play Multis, which are arrangements of up to 16 Programs split and/or layered in Zones across selected ranges of the keyboard.

By default the volume of the Program in the first 4 Zones can be easily adjusted while playing by using the sliders 1-4, and each Zone can be turned on or off by using the buttons below these sliders. The remaining controls are typically assigned to FX and Synth parameters. Controller settings can be adjusted in Multi Edit Mode.

Multi Edit Mode

Multi Edit Mode is used to modify the many parameters that make up Multis, including Program Selection, Key Range, Volume, Pan, and Controller assignments. Use Multi Edit Mode to create custom sound combinations.

To save a copy of the Multi with the changes you've made, press the SAVE button once to view the Save Dialog. The Save Dialog allows you to choose an ID number and name for the Multi you are saving. On the Multi Save Page, press the SAVE button again to save the Multi as a User Multi.

Song Mode

Song Mode allows you to record and play back songs, using up to 16 tracks of Programs.

Global Mode

Use Global Mode to adjust common settings that are shared between all Modes, such as velocity sensitivity and power saving options. Global Mode is also used for storing or loading User backup files, and restoring Factory default settings. Some of the more common settings are summarized below.

Info

The Info Page shows the currently installed operating system and sound object versions. Use this page to check if your PC4 is up to date with the most recent software and sounds posted at www.kurzweil.com.

Reset

You can return the PC4 to the Factory default state by doing a Reset.



Caution: Reset will delete all User objects, so it is important to back up your User objects before doing a Reset. Factory objects are not deleted.

Saving to External Storage

User objects that you have created can be saved to a USB Flash Drive.

Getting Started

Double Button Presses

Loading from External Storage

User objects can be loaded onto the PC4 from a USB Flash Drive. This allows you to load new sounds from Kurzweil or other developers, or to load sounds that you have previously saved.

Double Button Presses

Reset Transposition

To reset the current Program or Multi transposition to 0, simultaneously press both of the TRANSPOSE +/- buttons, or the OCTAVE+ and OCTAVE- soft buttons.

Program Demo

In Program Mode, to hear a Program Demo song for the current Program, press the 0/MISC and ENTER buttons simultaneously.

Song Demo

To hear the capabilities of the PC4, you can play the multi-channel demo songs. Press the USER and 0/MISC buttons simultaneously to listen to a multi-channel demo song.

Panic

Pressing the ENTER and KEYPAD buttons simultaneously deactivates all sounding notes by sending an “all notes off” message on all 16 MIDI channels.

Select Channel / Layer / Zone / Track / QA Bank 1

In Program Mode, pressing both of the CHANNEL/LAYER/ZONE/TRACK buttons simultaneously will select MIDI channel 1.

In Program Edit Mode, pressing both of the CHANNEL/LAYER/ZONE/TRACK buttons simultaneously will select Layer 1.

In Multi Edit Mode, pressing both of the CHANNEL/LAYER/ZONE/TRACK buttons simultaneously will select Zone 1.

In Song Mode, pressing both of the CHANNEL/LAYER/ZONE/TRACK buttons simultaneously will select Track 1.

In Program and Multi Mode, if Quick Access view is selected, pressing both of the CHANNEL/LAYER/ZONE/TRACK buttons simultaneously will select Quick Access Bank 1.

Select Next Unused ID

When selecting an ID number to save a previously saved User object, press the PREVIOUS and NEXT buttons simultaneously to jump between selecting the previously used ID number, and the next unused ID number.

Search

The Search page allows you to find any term or series of characters within the currently selected list or range of values. Hold the ENTER button and press one of the numeric buttons 1-9 to view the Search page.

On the search page, use the category buttons to type the term you want to find, then press the ENTER button to search. For example, if the program list is selected and you want to find all programs containing the word “Horn,” you would type h-o-r-n followed by the ENTER button. The Search page is not case-sensitive; it will find upper and lower case characters regardless of what you type.

After typing a term and pressing the ENTER button, the search page finds and selects the first instance of the term in the list (if it exists in the list). To find and select the next or previous instance of the term in the list, hold the ENTER button and press one of the NEXT or PREVIOUS button to search for the next higher-numbered or previous lower numbered object that contains the search term.



Note: Each combination of the ENTER button and a numeric button 1-9 allows you store a different search term. For example, hold the ENTER button and press the 1 button, then search for a term like “piano”. The term “piano” will now be available whenever you hold the ENTER button and press the 1 button. Next, hold the ENTER button and press the 2 button, then search for “string”. The term “string” will now be available whenever you hold the ENTER button and press the 2 button. A different term can be stored for each of the numeric buttons 1-9. These terms are stored until power off.

Chapter 2

Program Mode

Use Program Mode to play a Program directly from the keyboard, or to play up to 16 Programs multitimbrally via MIDI. Programs typically contain a single instrument sound, although some Programs may contain multiple instrument sounds.

The PC4 always powers on with Program Mode selected. To enter Program Mode from another Mode, press and turn on the PROGRAM Mode button, or press the EXIT button repeatedly until you reach Program Mode.

The PC4 powers on with Program 1 selected, or the Program that was selected the last time Global Mode was exited.

Selecting Programs

In Program Mode, use any of the methods below to select a Program.

Browse All Programs

Make sure the USER button is off, then use the ALPHA WHEEL or PREVIOUS and NEXT buttons to select a Program from all of the available Programs.

Select a Program by Category

Make sure the KEYPAD button is off, then press one of the CATEGORY buttons to select the first Program of a category (or the current Category Default Program). The selected CATEGORY button will turn on. Use the ALPHA WHEEL or PREVIOUS and NEXT buttons to select Programs from the selected category.

Program Mode

Program Demo

Select a Previously Saved User Program

Press and turn on the USER button, then use the ALPHA WHEEL or PREVIOUS and NEXT buttons to browse only User Programs. To return to browsing Factory and User Programs, press and turn off the USER button.

Select a Program by ID Number

Press and turn on the KEYPAD button. The keypad button allows you to use the numbers labeled on the CATEGORY buttons to select Programs or Multis by ID number. Type an ID number followed by pressing the ENTER button to select the associated Program.

Select a Category Default Program

Each category has a Category Default Program (the Program which is selected when each CATEGORY button is pressed). By default the Category Default Program is set to the first Program of each category. To set a different Category Default Program, select a Program, make sure the KEYPAD button is off, then press and hold the currently lit CATEGORY button.

Program Demo

To hear a Program Demo song for the current Program, press the 0/MISC and ENTER buttons simultaneously.

The Display

In Program Mode, the top line of the display shows the current Mode, MIDI transposition, MIDI In/Out activity indicators, and MIDI channel. If Quick Access view is selected, the current Quick Access Bank number will be shown instead of the current MIDI channel.

The currently selected Program ID number and name are shown in the center of the display. If the selected program is a user program, a KB3 organ program, or if the program contains an FM layer, the USER, KB3, or FM icons are displayed next to the program name.

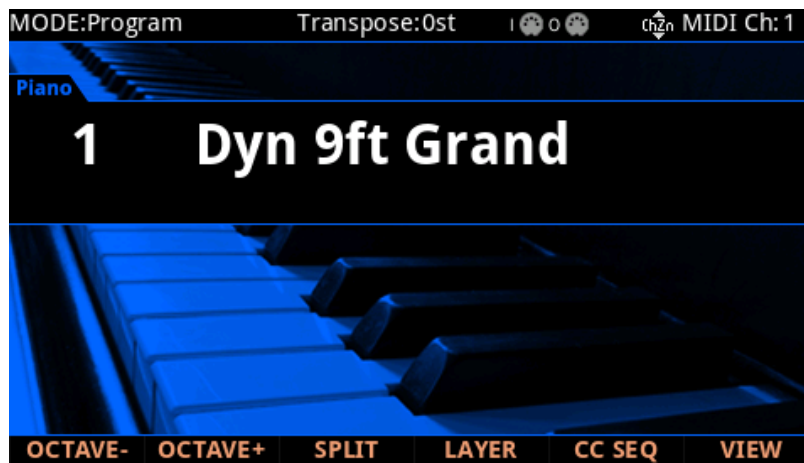

MIDI In/Out Activity Indicators

MIDI In/Out activity indicators are displayed at the top of the screen (shown as 2 MIDI port symbols with “I” for “in” and “O” for “out”). These indicators briefly light up when MIDI has been recently sent to or received by the PC4’s MIDI/USB ports. If the symbol is green, this indicates there has been MIDI activity on that port in the last few seconds. If the symbol is red, this indicates there has been communication with the external software editor on that port in the last few seconds. If the symbol is grey, this indicates there has been no MIDI activity on that port in the last few seconds.

OCTAVE Soft Buttons

The OCTAVE- and OCTAVE+ buttons can be used to change the tuning of notes played on the PC4 keyboard in octaves.

The current transpose amount is shown in the top line of the display. Press both OCTAVE buttons simultaneously to reset the transposition to 0.

The OCTAVE buttons also transpose MIDI notes sent to the USB and MIDI Out ports.

SPLIT and LAYER Soft Buttons

Use the SPLIT and LAYER soft buttons to split and layer multiple Programs across the keyboard. For details see [“The Split and Layer Soft Buttons” on page 2-6.](#)

CC SEQ Soft Button

Press the CC SEQ soft button to turn the CC Sequencer On or Off. When the CC Sequencer is On, the CC SEQ soft button turns green.

The CC Sequencer allows you to rhythmically modulate up to 4 program parameters (such as filter frequency) based on preset or user patterns. For details on the CC Sequencer, see [“The CC Sequencer \(CC SEQ\) Page” on page 3-35.](#)

VIEW Soft Button and Quick Access View

Press the VIEW soft button to switch between the default Large view, List view, and Quick Access view.

Quick Access view shows the names of 10 favorite Programs and/or Multis, which can be selected by pressing the corresponding numbers on the Keypad. To access more than 10 Programs/Multis, use the CHANNEL/LAYER/ZONE/TRACK buttons to select a different Quick Access Bank. Programs or Multis which are not stored in a Quick Access Bank can be browsed by using the ALPHA WHEEL or PREVIOUS/NEXT buttons.

When Quick Access view is selected, press and hold one of the Keypad buttons (0 through 9) to store the currently selected Program or Multi to a spot in the current Quick Access Bank. For details on Quick Access view, see [“Display” on page 9-3.](#)



Note: When Quick Access view is selected, the Category buttons always select an entry in the current Quick Access bank, despite the state of the KEYPAD button. In Program Mode, when Quick Access is selected, the state of the KEYPAD button determines whether programs browsed by using the ALPHA WHEEL or PREVIOUS/NEXT buttons are ordered based on category order then ID number (KEYPAD off), or based on ID number only and ignoring category (KEYPAD on).

Controllers

In Program Mode, you can use the PC4 physical controllers (the Knobs, Sliders, Buttons, Wheels, Pedals, and Ribbon) to modify an instrument sound during a performance to add variation or expression.



Note: Assigned parameter names are not visible in List view, or if the Global Mode “Show Controllers” parameter is set to No.

If you make changes to the current Program using any of the controllers, the SAVE button lights up to indicate that a change has been made to that Program. For more information on the SAVE button, see [Save User Programs on page 2-10](#).

VAST Program Controller Assignments

In each of the Factory VAST Programs, each control will usually perform the assignment labeled on the front panel between the Knobs and Sliders. Some controls may have different assignments per Program. When a controller is moved, the name of the current assignment is shown in the display. Controller assignments can be adjusted in Program Edit Mode.

KB3 Program Controller Assignments

In each of the Factory KB3 Organ Programs, each control will usually perform the assignment labeled on the front panel below the Sliders. The display shows “KB3” when a KB3 Program is selected. When a controller is moved, the name of the current assignment is shown in the display. Controller assignments can be adjusted in Program Edit Mode.

TRANSPOSE Buttons

The TRANSPOSE buttons can be used to change the tuning of notes played on the PC4 keyboard in semitones (also known as half steps). This is a convenient way to change the key of a song without learning to play it in a different key.

The current transpose amount is shown in the top line of the display. Press both TRANSPOSE buttons simultaneously to reset the transposition to 0.

The TRANSPOSE buttons also transpose MIDI notes sent to the USB and MIDI Out ports.

Program Mode

The Split and Layer Soft Buttons

The Split and Layer Soft Buttons

The Split and Layer functions have identical parameters, but produce different results.

The Split function allows you to quickly create a Multi such that keys in one range of the keyboard produce different sounds than another range.

The Layer function allows you to layer Programs and Multis such that more than one instrument sound can be produced by playing one key.

The Split and Layer functions allow you to quickly create Multis without using Multi Edit Mode to configure Zone key ranges, Programs, and volumes. After creating and saving a Split or Layer Multi, you can edit additional Multi parameters in Multi Edit mode.

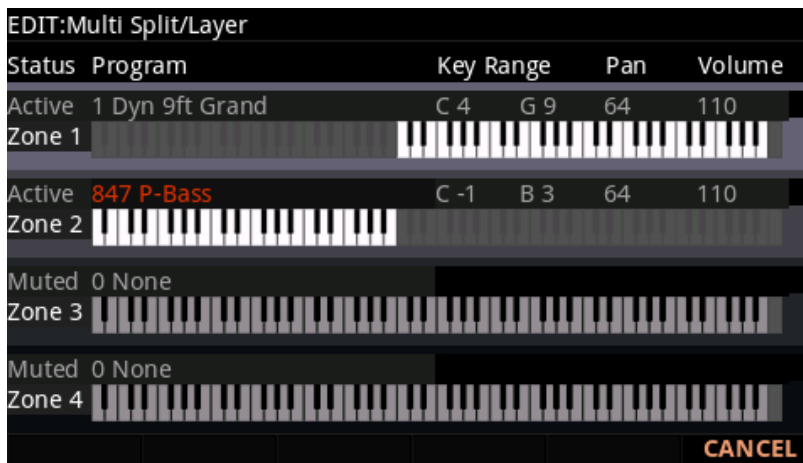

The Split Function

When you create a Split in Program Mode, you are creating a Multi with two Zones set to On.

The Program you were using in Program Mode is used in the right hand of the Split as the Zone 1 Program. You can choose a Program that will be used in the left hand of the Split as the Zone 2 Program.

Follow these steps to create a Split:

1. In Program Mode, select a Program for the right hand of the Split.
2. Press the SPLIT soft button.
3. On the “Split” Page, Zone 2 is selected with a default Bass Program selected for the left hand of the Split. Use the ALPHA WHEEL or CATEGORY buttons to select a different Program for the left hand of the Split.

4. If desired you may wish to adjust additional Split parameters, described in [Split and Layer Parameters on page 2-7](#).
5. Press the SAVE button to save your Split as a Multi (See below for details on saving). After saving your Split Multi, you can edit additional Multi parameters in Multi Edit mode.

The Layer Function

When you create a Layer in Program Mode, you are creating a Multi with two Zones set to On.

The Program you were using in Program Mode is used for the Zone 1 Program. You can choose a Program that will be used as the layered Zone 2 Program.

Follow these steps to create a Layer:

1. In Program Mode, select a Program that you wish to layer.
2. Press the LAYER soft button.
3. On the “Layer” Page, Zone 2 is selected with a default layer Program selected for the layered Zone 2 Program. Use the ALPHA WHEEL or CATEGORY buttons to select a different Program for the layered Zone 2 Program.
4. If desired you may wish to adjust additional Layer parameters, described in [Split and Layer Parameters on page 2-7](#).
5. Press the SAVE button to save your Layer as a Multi (See below for details on saving). After saving your Layer Multi, you can edit additional Multi parameters in Multi Edit mode.

Split and Layer Parameters

There are five parameters (described below) that determine the behavior of Splits and Layers. Use the cursor buttons to access each of the parameters for each active Zone.

Status (Zone Status)

You can activate additional Zones with the Status parameter or the buttons in the front panel CONTROL section.

Program

Use the Program parameter to select a Program for each Zone. Use the Category buttons, the Alpha Wheel, the Previous/Next buttons, or enable the Keypad button and type an ID number followed by the Enter button.

Program Mode

The Split and Layer Soft Buttons

Volume

To change the volume of a Zone, use the cursor buttons to select the Volume parameter for one of the Zones. To set a volume, use the Alpha Wheel, the Previous/Next buttons, or use the keypad function of the Category buttons to type a volume (0-127) followed by the Enter button.

A value of “None” will use the last volume value used by the Zone’s MIDI channel (often set by the expression pedal). A value of “None” can be entered by scrolling below 0, or by using the keypad function of the Category buttons to type negative 1 by pressing the small +/- button and then the 1 button, followed by the Enter button.

Key Range

You can adjust the boundary between the left and right hand Programs on the keyboard by adjusting the Key Range low and Key Range high parameters for each Zone. The keyboard display for each Zone shows a visual indication of the Key Range by dimming keys that are outside of the Key Range.

To change the Key Range of a Zone, use the cursor buttons to select the Key Range low or Key Range high parameters for one of the Zones. Key Range low and Key Range high are the left and right parameters, respectively, below the Key Range label. With one of these parameters selected, set the Key Range by using the Alpha Wheel, the Previous/Next buttons, or use the keypad function of the Category buttons to type a key number (0-127) followed by the Enter button. With Key Range low or Key Range high selected, the value can also be changed by holding the Enter button, then pressing the desired key.

Pan

To change the panning of a Zone (left/right stereo placement), use the cursor buttons to select the Pan parameter for one of the Zones. To set a Pan value, use the Alpha Wheel, the Previous/Next buttons, or use the keypad function of the Category buttons to type a pan value (0-127) followed by the Enter button. A value of 0 is full left, 64 is center, and 127 is full right. Other values will move the stereo placement in between these positions. A value of “None” will use the last pan value used by the Zone’s MIDI channel.

A value of “None” can be entered by scrolling below 0, or by using the keypad function of the Category buttons to type negative 1 by pressing the +/- button and then the 1 button, followed by the Enter button.

Saving a Split or Layer

After setting the Split or Layer parameters, your changes can be saved as a Multi that it can easily be recalled in Multi Mode. Press the Save button to the left of the display to begin the saving process. A Multi name is automatically created using half of the original Program name and half of the default Zone 2 program name. This name can be edited during the saving process. See [Saving a User Multi on page 6-10](#) in the Multi Mode Chapter for details on saving.

Once you have saved your Split or Layer as a Multi, you can continue to add additional Zones, edit controller assignments (like effects controls and sustain pedal per Zone), transposition per Zone, and other Multi parameters. (See [Ch. 7 Multi Edit Mode](#) for details.)

Changing the MIDI Channel

The current MIDI channel is shown on the right side of the top line of the display. Press the CHANNEL/LAYER/ZONE/TRACK Up or Down buttons to change the MIDI channel. Pressing both of the CHANNEL/LAYER/ZONE/TRACK buttons simultaneously will select MIDI channel 1.

A different Program can be selected for each MIDI Channel. All channels can be triggered simultaneously from an external MIDI sequencer or computer.



Note: The Aux FX Chains of the Program on the currently selected MIDI channel are used for Programs on all Channels.



Note: If Quick Access view is selected, the CHANNEL/LAYER/ZONE/TRACK Up or Down buttons will select the current Quick Access Bank, and the Quick Access Bank number will be shown instead of the current MIDI channel. For details on Quick Access view, see [“Display” on page 9-3](#).

Panic

Pressing the ENTER and KEYPAD buttons simultaneously deactivates all sounding notes by sending an “all notes off” message on all 16 MIDI channels.

Save User Programs

If you make changes to the current Program using any of the controllers, the Save button's LED lights to indicate that a change has been made to that Program.

To save a copy of the Program with the changes you've made, press the Save button once to view the Save Dialog. The Save Dialog allows you to choose an ID number to that will be associated with the program you are saving. When viewing the Save Dialog, you can quickly save the Program to the displayed ID number by pressing the Save button again.

Changing ID Numbers

The display shows the first available ID number and the current Program name. User Programs can be saved to ID numbers from 4096 to 8191.



If you are saving a Program that has not been previously edited, the next available unused ID number will be selected.

If you are saving a previously edited User Program, the ID number that the Program was last saved with will be selected.

Press the Previous and Next buttons simultaneously to toggle between selecting the ID number that the Program was last saved with and the next available unused ID number.

To change the ID number, turn the Alpha Wheel or use the Previous/Next buttons to select the new ID number. The label underneath indicates if it is an "Unused ID". You can also use the keypad function of the Category buttons to type an ID number, followed by pressing the Enter button

If you select an ID currently in use, the display will notify you that by saving you will "replace" the Program currently in that location. Confirm overwriting of the existing Program by pressing Save, or choose a different ID.

Naming a User Program

To rename the Program, first press the RENAME soft button. The display shows the current Program name.



Use the Category buttons, Alpha Wheel or Previous/Next buttons to change each character.

Use the Left/Right cursor buttons or <<< >>> soft buttons to move the cursor.

Press the +/- button to switch between upper and lower case characters.

Use the Insert button to insert a blank space. The selected character and all characters to the right will move one space to the right.

Use the Delete button to delete the current character (all the characters to the right will move one space to the left).

Saving a User Program

Press the Save button or Save soft button to complete the saving process, or press the Cancel soft button to exit without saving. After successfully saving, the Program will be selected in Program Mode.

To find the Program again later, press the User button and scroll to the Program ID. You can also find the program by pressing the appropriate Category button and scrolling past the factory programs. Lastly, you can press the Keypad button so that its LED is lit, type the Program ID number, then press the Enter button.

Chapter 3

Program Edit Mode

Program Edit Mode allows you to edit and customize Programs. Any Program can be edited in Program Edit Mode and saved to a User ID.

To enter Program Edit Mode, first press the PROGRAM Mode button to enter Program Mode, then press the EDIT button.

Program Types

The PC4 contains VAST and KB3 Programs.

VAST Programs can use layers of samples and synthesis suitable for generating a wide variety of traditional instrument sounds, as well as synthesizer sounds. For details on editing VAST programs, see [Editing VAST Programs on page 3-2](#).

KB3 Programs contain a set of oscillators designed to emulate the tone wheels in a classic tone wheel organ. For details on editing KB3 programs, see [Editing KB3 Programs on page 3-107](#).

Editing VAST Programs

VAST Program Features

VAST programs can utilize many common synthesizer features, in addition to some uncommon features. Some notable features:

- **KDFX:** Each of the 32 possible VAST layers can be individually processed by a layer insert FX Chain. All Layers can be processed a common insert FX Chain and two common Aux FX Chains.
- **Intonation and Tuning Maps:** Each VAST program can have its own Intonation Map (tuning repeated across each octave) and Tuning Map (tuning per note).
- **KSR:** Kurzweil Piano String Resonance Simulation.
- **CC Sequencer:** A step sequencer to control synthesizer parameters.
- **KVA Oscillators:** Anti-aliased synthesizer oscillators.
- **Cascade Mode:** Route the audio of any of the 32 layers of a program into the DSP ALG of any other layer.
- **Dynamic VAST:** Combine different DSP functions in any order you like, including parallel and serial configurations.
- **FM Layers:** FM layers contain a set of oscillators designed to emulate classic 6 operator FM synthesizers.

VAST Program Structure

The diagram below depicts the hierarchy of a VAST program, from individual samples all the way up to Multis, which can contain up to 16 programs.

Every VAST program contains at least one layer (32 layers maximum). Each layer can use a keymap of samples or a synth oscillator as sound sources. The sound sources in each layer can be individually processed with an algorithm containing DSP functions. Each Layer can also be individually processed by a layer insert FX Chain. All Layers can be processed a common insert FX Chain and two common Aux FX Chains.

Each VAST layer uses one of the 256 voices of the PC4 (two voices for stereo samples). Each FM layer uses 4 voices.

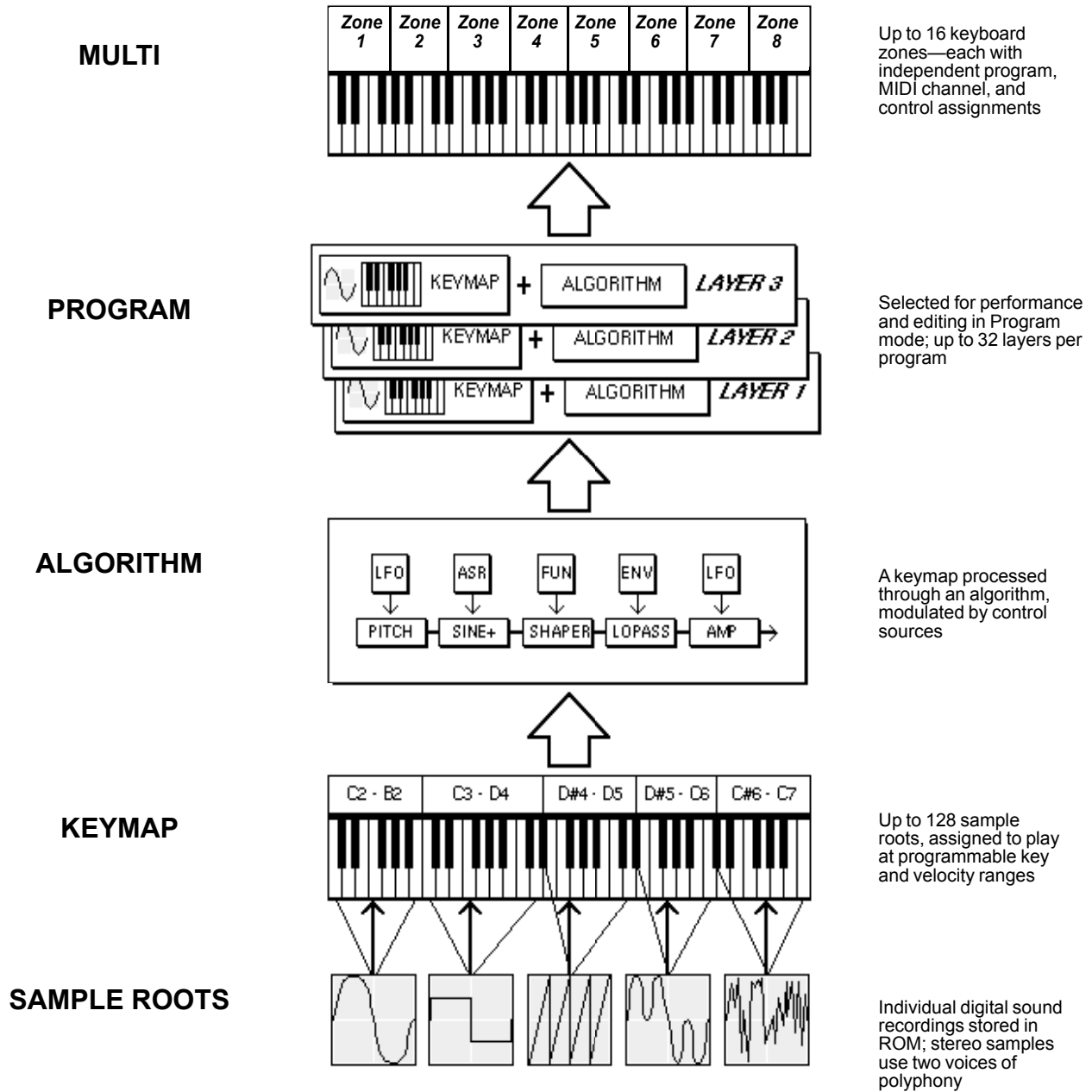

Note: When using a KVA oscillator, the sound source for that layer is generated at the algorithm stage. See [Editing VAST Programs With KVA Oscillators on page 3-74](#) for more details.

Navigation

Press the soft buttons at the bottom of the screen to navigate to each page, or to perform the labeled function.

Use the cursor buttons to select each parameter, and the PREVIOUS/NEXT buttons, Alpha Wheel, or CATEGORY buttons to change each value.

When certain parameters are selected, additional editor pages or functions can be accessed by pressing the EDIT button. The EDIT button lights up when the EDIT button can be used.

Soft Buttons in the Program Editor

Press the soft buttons at the bottom of the screen to navigate to each page, or to perform the labeled function.

Press the MORE soft buttons to view more sets of soft buttons.

See the rest of this chapter for details on each of the Program Edit Mode pages.

See [“The Soft Button Functions” on page 3-71](#) for details on soft button functions in Program Edit Mode pages.

Layers

Use the CHANNEL/LAYER/ZONE/TRACK buttons to change the current Layer. Most parameters apply only to the currently selected Layer, which will be shown in the top right corner of the display.

Parameters on the PARAMS Page, FX Page, COMMON Page and ARP Page apply to all Layers.

The EDIT Button in the Program Editor

When certain parameters are selected, additional editor pages or functions can be accessed by pressing the EDIT button. The EDIT button lights up when the EDIT button can be used.

Sub Editors

Press the EDIT button to enter sub editors when the following fields are selected:

- Parameters on the PARAMS page
- FX Chains on the FX or LYR FX pages
- Intonation Maps on the COMMON page
- Keymaps on the KEYMAP page
- Samples within the Keymap editor

- Patterns on the ARP page (Shift, Velocity, and Duration)
- Algorithms on the ALG page

Jump

When a Program Edit source field is selected and assigned to a physical controller or CC number, press the EDIT button to jump to the associated parameter on the Parameters Page.

When a Program Edit source field is selected and assigned to an envelope, LFO, ASR or FUN, press the EDIT button to jump to an associated field on the envelope or LFO+ pages.

Assign

Assign is the secondary function of the ENTER button. You can use the Assign function to quickly select parameters or set values for parameters by holding the ENTER button while moving PC4 controllers (Knobs, Sliders, Buttons, Keys, Wheels, and Pedals).

Parameters that can use the Assign function are indicated by showing the Assign symbol in the top right corner of the display when selected.

Select an Assigned Parameter

When the PARAMS Page Parameter column is selected, hold the ENTER button and move a controller to select the assigned parameter (if a parameter is assigned to that controller). This is an easy way to check if a controller is unused, or is already being used by a parameter.

Assign a Physical Controller

When the PARAMS Page Control column or a Program Edit source field is selected, hold the ENTER button and move a physical controller to assign the moved controller to the selected parameter or source field.

Assign a Control Source

When a Program Edit source field is selected, hold the ENTER button and press one of the keyboard keys. Each of the 88 keys will select one of the available control sources.

Select a Key Range

When the LAYER Page Low Key or High Key fields are selected, hold the ENTER button and press a keyboard key to set the Low Key or High Key.

The PARAMS Page

The PARAMS page shows all Program and FX parameters for the current program that have been assigned to be controlled by the PC4's physical controllers, or by MIDI CCs from an external MIDI device.

Use the PARAMS page to change controller and MIDI CC assignments, set an initial MIDI value for each controller assignment, and edit the name displayed for each controller assignment.

When controller or MIDI assignments are made on other Program or FX Edit pages, or if an FX Chain is selected which contains controller assignments, these parameters are automatically added to the Parameters page.

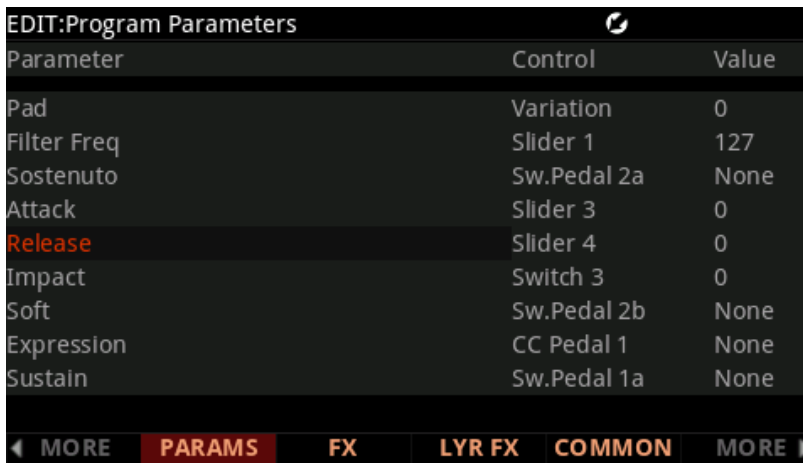

Parameter	Control	Value
Pad	Variation	0
Filter Freq	Slider 1	127
Sostenuto	Sw.Pedal 2a	None
Attack	Slider 3	0
Release	Slider 4	0
Impact	Switch 3	0
Soft	Sw.Pedal 2b	None
Expression	CC Pedal 1	None
Sustain	Sw.Pedal 1a	None

Navigation: ◀ MORE | **PARAMS** | FX | LYR FX | COMMON | MORE ▶

Parameter Column

The Parameter column shows all Program and FX parameters for the current program that have been assigned to be controlled by the PC4's physical controllers, or by MIDI CCs from an external MIDI device.

Effect Chain parameters are named with prefixes based on their effect type: “INS” for parameters from Insert effects, “LFX” for parameters from layer effects, and “AUX1” or “AUX2” for parameters from Aux effects.

To quickly find a parameter that is already assigned to a controller, select the parameter column, hold the **ENTER** button and move a controller to select the assigned parameter.

Control Column

The Control column determines which physical controller (or external MIDI CC number) will control the parameter in the selected row. To quickly assign one of the PC4's physical controllers to a parameter, select the control column in the row of the desired parameter, hold the **ENTER** button and move the desired controller. Alternatively, you can use the Alpha Wheel or the Previous/Next buttons to select a controller from the list, or type in the controller's MIDI number followed by the ENTER button. See below for a list of PC4 physical controllers and their associated MIDI numbers.

If you want to disable the controller for a parameter, you can select a value of None by scrolling to the bottom of the controller list (using the Alpha Wheel or the Previous/Next buttons), or type -1 followed by the ENTER button.

To choose an external MIDI CC number as a control source, you can enter the number of the controller followed by the **ENTER** button, or use the Alpha Wheel or the Previous/Next buttons. The PC4's physical controllers each use one of the available MIDI CC numbers, so you must choose one of the other available CC numbers when using an external MIDI control source or else the parameter will also be controlled by a PC4 physical controller. MIDI CC numbers associated with the PC4's physical controllers are shown in the list below.

PC4 Physical Controller MIDI CC Numbers

Mod Wheel (MIDI CC 1)	Slider 4 (MIDI CC 23)	Knob 3 (MIDI CC 72)
Knob 8 (MIDI CC 3)	Slider 5 (MIDI CC 24)	Knob 2 (MIDI CC 73)
CC Pedal 2 (MIDI CC 4)	Slider 6 (MIDI CC 25)	Knob 4 (MIDI CC 79)
Knob 9 (MIDI CC 9)	Slider 7 (MIDI CC 26)	Switch 1 (MIDI CC 80)
CC Pedal 1 (MIDI CC 11)	Slider 8 (MIDI CC 27)	Switch 2 (MIDI CC 81)
Slider 1 (MIDI CC 12)	Slider 9 (MIDI CC 28)	Switch 3 (MIDI CC 82)
Slider 2 (MIDI CC 13)	Variation Button (MIDI CC 29)	Switch 4 (MIDI CC 83)
Knob 5 (MIDI CC 14)	Sw. Pedal 1a (MIDI CC 64)	Switch 5 (MIDI CC 85)
Knob 6 (MIDI CC 17)	Sw. Pedal 1b (MIDI CC 66)	Switch 6 (MIDI CC 86)
Knob 7 (MIDI CC 18)	Sw. Pedal 2a (MIDI CC 66)	Switch 7 (MIDI CC 87)
Ribbon Section 1 (MIDI CC 21)	Sw. Pedal 2b (MIDI CC 67)	Switch 8 (MIDI CC 89)
Slider 3 (MIDI CC 22)	Knob 1 (MIDI CC 71)	Switch 9 (MIDI CC 90)

Value Column

To change the value of a parameter, use the cursor button to highlight the right column. In the value column, use the Alpha Wheel or the Previous/Next buttons to enter a MIDI value from 0-127, or a value of None by scrolling below 0. You can also use the keypad function of the Category buttons followed by the ENTER button to enter a MIDI value. If you set a MIDI Value to None by scrolling below 0, the MIDI value will be 0 until you change the value with an assigned controller (though None will still be displayed). A value of None can also be selected by using the keypad to type -1, followed by the ENTER button.



Important Note: Values of “None”

For factory programs, standard parameters like Expression (program volume), Sustain, and Sostenuto are always set to **None** by default. If you change one of these values, either on the PARAMS page in the Program Editor, or with a physical controller from Program Mode (or the Program Editor,) **the same value will be used for any other program you select**, if you select another program that uses a value of **None** for the same parameter. **These values remain set even if you don't save the program.**

This can be useful, for example, when using an expression pedal to control program volume. By default, all factory programs have their Expression parameter set to a value of **None**, and Expression (program volume) by default can be controlled by an expression pedal plugged into the CC 1 Pedal jack. With an expression pedal plugged into the CC 1 Pedal jack, you can control the volume of any factory program, but when you select another factory program, it will have the same volume that you set with the expression pedal in the last program. This way, the volume of your programs will stay consistent, and can always be changed by the expression pedal. If you want a program to have a default volume, you must set a Value other than **None** for the Expression parameter.

For all parameters with a Value of None, any values set with a physical control will not be saved when saving the program. You must set the Value column for that parameter to something other than None in order to set and save a value. These values will remain set until changed with a controller, or until a program is loaded on the current MIDI channel that does not have a value of None for these parameters.

Parameter Edit

Select a Parameter and press the **EDIT** button to view the Parameter Edit page. The Parameter Edit page allows you to view the Parameter's Destination, Entry Value, Control, and Text name. The parameter name can be edited, see below for details.

Press the **BACK** soft button to return to the PARAMS page, or press the **DELETE** soft button to delete the current Parameter.

EDIT:Program Parameters Edit	
Destination	23
Entry Value	0
Control	23
Text	Release

DELETE BACK

Destination

A parameter's Destination is automatically set when the Parameter is created, and can not be changed. A PARAMS page Parameter will control any Program Edit or FX Edit parameter which has its source field set to the same destination number. For details see [“PARAMS Page Parameter Destination” on page 3-12.](#)

Entry Value and Control

These parameters are equivalent to the PARAMS page Value column and Control column.

Text

To change the Parameter's name, use the Navigation buttons to select the Text field, then press the **EDIT** button to enter the Parameter Name page, where you can rename the Parameter. Use the Navigation buttons and soft buttons to change the Parameter name. Press **OK** to save the new parameter name, or **CANCEL** to return to the previous page.

Adding Parameters to the PARAMS Page

To add parameters to the PARAMS page, a controller assignment must be made using a source field on one of the Program Edit or FX Edit pages. Controllable parameters each have a source field. All source fields are listed below:

VAST Program Source Fields

[The FX Page on page 3-13](#)

- Mod

[The Layer FX \(LYR FX\) Page on page 3-16](#)

- Aux1 Mod, Aux2 Mod

[The KEYMAP Page on page 3-40](#)

- Alt Control

[The LAYER Page on page 3-45](#)

- Enable

[The DSP Modulation \(DSP MOD\) Page on page 3-56](#)

- Source 1, Source 2, Depth Ctl

[The OUTPUT Page on page 3-58](#)

- Mod

[Envelope Control on page 3-63](#)

- Source

[The LFO+ Page on page 3-67](#)

- RateCt, Trigger, Input a, Input b

[FM Operator Page on page 3-86](#)

- Level Source 1, Level Source 2, Freq Source 1, Freq Source 2

[FM Amp + Output Page on page 3-97](#)

- Source 1, Source 2, Crossfade

[FM Alt Input Page on page 3-99](#)

- Source 1, Source 2

KB3 Program Source Fields

[KB3 Editor: The PITCH Page on page 3-114](#)

- Source 1, Source 2

[KB3 Editor: The AMP Page on page 3-114](#)

- Source 1, Source 2

[KB3 Editor: The LFO+, ARP and CC SEQ Pages on page 3-119](#)

- RateCt, Trigger, Input a, Input b

Chain Edit Source Fields

[The MOD Pages on page 4-3](#)

- Source

[FXLFO+ page on page 4-5](#)

- RateCt, Trigger, Input a, Input b

Adding Physical Controllers

To assign a PC4 physical controller, select the source field for the parameter, hold the ENTER button and move the controller.

Adding MIDI CC Numbers

To assign a CC number to a source field, enter a number from 1-31 or 64-95 with the alphanumeric pad, then press Enter. A CC number for an external controller can also be set by selecting the source field for the parameter, holding the ENTER button, and sending a CC value from the external MIDI controller.



Note: The PC4's physical controllers each use one of the available MIDI CC numbers, so you must choose one of the other available CC numbers when using an external MIDI control source or else the parameter will also be controlled by a PC4 physical controller. See the [PC4 Physical Controller MIDI CC Numbers on page 3-7](#) for a list of CC numbers used by the PC4's physical controllers. Some MIDI CCs are also hard wired to control certain program parameters or functions such as MIDI 5 (Portamento Time), MIDI 7 (Program Volume), MIDI 10 (Pan), MIDI 11 (Expression/Program Volume), MIDI 64 (Sustain), MIDI 66 (Sostenuto), so if you use one of these numbers the CC will always perform the hard wired function, in addition to any other assignment you make.

Program Edit Mode

The PARAMS Page

Program Edit Source Names

When assigning a physical controller or CC number to a Program Edit source field, the source field will show a default MIDI CC number (the destination), followed by the assigned physical controller name or MIDI CC number (the control name). For example assigning Slider 1 shows “12 Slider 1”, and assigning MIDI CC 5 shows “5 MIDI 5”).



Note: If a parameter assignment is changed on the PARAMS page using the Control column, the Program Edit source field will update the control name, while maintaining the same destination number. For example, in a clear Program assign the DSP MOD page Pitch Source 1 to “12 Slider 1”. A “Pitch” parameter will appear on the Parameters page, with its Control set to Slider 1. On the PARAMS page, change Pitch Control column to Slider 2. The DSP MOD page Pitch Source 1 field will now show “12 Slider 2”.

PARAMS Page Parameter Destination

On the PARAMS page, press the EDIT button to see a Parameter’s Destination field. A parameter’s Destination is automatically set when the Parameter is created, and can not be changed.

A PARAMS page Parameter will control any Program Edit or FX Edit parameter which has its source field set to the same destination number. When an assigned Program Edit source field is selected, you can jump to selecting the controlling PARAMS page parameter by pressing the EDIT button.

PARAMS Page Parameter Shared Assignments

When assigning a physical controller or CC number to a source field, a Parameter is automatically added to the PARAMS Page with the name of the first assigned Program Edit parameter.

If you assign a source field to a destination number that is already used by a parameter on the PARAMS page, a new parameter will not be added to the PARAMS page. The new assignment will share the existing Parameter on the PARAMS page (Name, Control assignment and initial Value). The existing Parameter will control multiple assignments, but the existing Parameter’s name will not change to reflect this. You can edit the Parameter name by selecting the Parameter and pressing the EDIT button to access the parameter edit page. See [Parameter Edit on page 3-9](#) for details.

The FX Page

Use the FX page to apply audio effects to a Program. You can select an Insert effects Chain and 2 Aux effects Chains, all of which apply to all layers in the Program (unless Layer FX are used, see below for details). In Program Mode, Programs on all MIDI channels share the Aux chains of the Program on the currently selected MIDI channel.

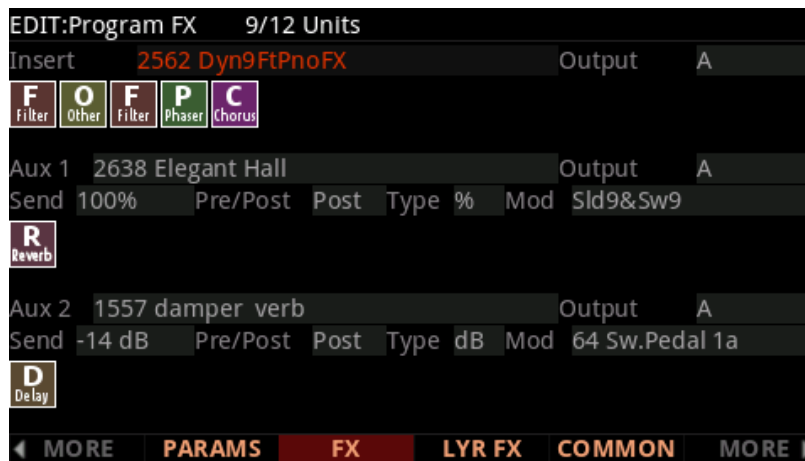

The PC4's Chains contain a variety of effects. Each Chain displays icons representing the type of effects contained in the Chain, as well as the order of effects in the Chain (signal flows from left to right). The PC4's Chains include different types of reverb, chorus, delay, flanger, phaser, tremolo, panner, rotary, distortion, EQ, compression, filter, envelope following filter, frequency stimulator, ring modulator, frequency offset, pitch LFO, and stereoizer.

The selected Chain can be edited by pressing the **EDIT** button. See [Ch. 4 The Effects Chain Editor](#) for details.

DSP Resources and DSP Units

A Program can have up to 8 Insert Chains (any combination of common and layer specific inserts) and 2 Aux Chains.

The PC4 has 32 “units” of effects resources that can be used to load effects chains. Each FX chain requires a certain number of FX units in order to load, depending on its complexity.

The top line of the display shows a fraction with the number of units used by the selected channel, over the total number of units used. When attempting to use more than 32 units of FX resources at once, some FX Chains will not be loaded.

Program Edit Mode

The FX Page

When sustaining notes while switching between 2 Programs, FX resources from the first Program may be “stolen” in order to load effects from the second Program. Because of this, you may hear a change in the sound of the first Program when switching to the second Program. If both Programs each use 14 DSP Units or less, then in most cases FX resources will not be stolen from the first Program, and you should not hear a change in the sound of the first Program.

Insert

Choose an effects Chain that will be applied to the current program. If you only need to use one Chain at a time on one MIDI channel, Insert effects may be all you need. If you plan to use multiple programs on different MIDI channels, it is best to use both Insert and Aux effects (see Aux below). Aux effects have the advantage of being available to all programs on each MIDI channel at the same time.

Aux 1, Aux 2

Choose an effects Chain for each of the two auxiliary audio buses. An aux bus is an audio channel with a shared effects Chain that can be used by programs on any of the 16 MIDI channels. The aux effect is useful when you want to use the same type of effect for multiple channels (typically used for Reverb or Delay). You apply an aux effect to the program on a MIDI channel by “sending” the audio from that channel to an aux bus.

Every channel is connected to the aux buses, but the aux buses don't receive the signal until you turn up the aux “send” level for that channel, which controls a channel's input level to the aux bus. On each MIDI channel you can control the aux send level for that channel's program, in turn controlling how loudly you can hear the aux effect applied to that channel's program. The aux send level is set by the Aux 1 and Aux 2 Send parameters on the FX page. Many Chains also have an additional Aux send, Wet/Dry, or Amount parameter that will appear on the PARAMS page. For Reverb and Delay Chains, send parameters are often assigned by default to Slider 9 or Slider 8 respectively.

Output

The Output parameter specifies the rear panel analog output pair to which the selected aux bus is routed. Setting the Output to A routes the signal of the selected bus to output pair A. Setting the Output to B routes the signal of the selected bus to output pair B. This is useful if you want to control the processed Aux signal with an external mixer or process the signal with additional external effects.

Send

The Aux Send parameters determine how much of the Program's signal is sent to each Aux FX Chain. Depending on the Type parameter, the send values are set either in dB or wet/dry percent.

Pre/Post

The Aux Pre/Post parameters determine whether or not the output of the Insert chain is sent to each Aux Chain (the "pre" or "post" insert signal).

When set to Pre, the output of the Insert chain is not sent to the Aux Chain.

When set to Post, the output of the Insert chain is sent to the Aux Chain.

Type

The Type parameter determines the values used for each Send parameter (dB or percent), and whether or not each send will work as a wet/dry control.

When Type is set to dB, the Aux send level is set in dB and works like a traditional send on an audio mixing board. As you turn up the Aux send, the Aux Chain's processed wet signal is layered over the program's unprocessed dry signal. Setting Type to dB is useful for setting a precise send value. The level of signal sent to the Chain is set in dB, the higher the value the more processed signal you will hear.

When Type is set to %, the Aux send level is set in % and works as a dry/wet mix. As you turn up the Aux send, the Aux Chain's processed wet signal is turned up and begins to replace the program's unprocessed dry signal, which is turned down. For example, with an Aux send set to 50% you hear an equal amount of unprocessed (dry) and processed (wet) signal. With an Aux send set to 100% you hear only the processed (wet) signal and none of the original unprocessed (dry) signal. Typically it's best to set Type to % when a continuous controller (like a Slider) is assigned to the Mod parameter, because it will give the controller more usable range than when set to dB.

Mod

Use each Mod parameter to select a physical controller or other control source to adjust each Aux Send value. The selected Mod control source will adjust the Send level using the range set by the Send parameter.

The Layer FX (LYR FX) Page

Use the Layer FX page to apply audio effects to individual layers of a Program.

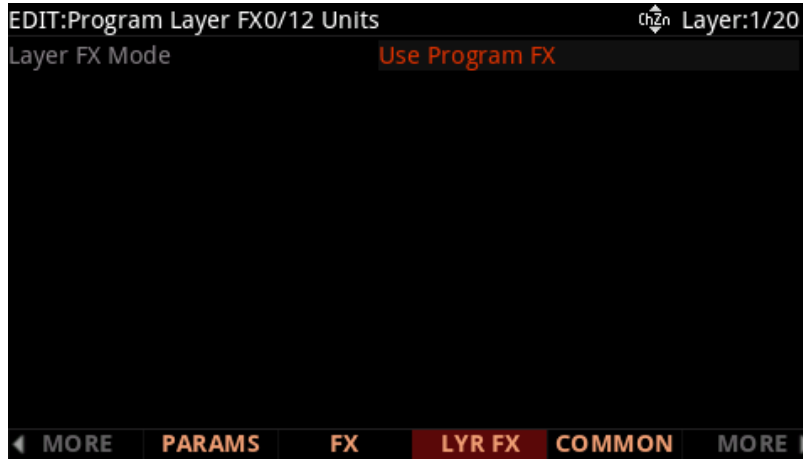

Layer FX Mode

Select a Layer FX Mode to determine how effects will be applied to each layer. See below for details on each mode:

Use Program FX

With **Use Program FX** selected, the current layer will use the effects configured on the FX page. See [The FX Page](#) above for more information on program FX.

Layer-Specific FX

With **Layer-Specific FX** selected, you can configure the effects for the current layer. A Program can have up to 8 Insert Chains (any combination of common and layer specific inserts).

The Layer specific parameters are the same as on the FX page, except they apply only to the current layer, and some of the Aux parameters are not available (the settings from the FX page are used for the Aux 1 and Aux 2 Chain and Output parameters). See [The FX Page](#) above for more information on these parameters.

In this mode, the Aux parameters on this page apply to the Aux Chains selected on the FX page.

Use Another Layer's FX

With **Use Another Layer's FX** selected, you can put the current layer through the Insert Chain and Aux effects settings of another layer. Use the "Use FX From Layer" parameter to select the layer whose effects you wish to use.

The COMMON Page

The Common Page contains parameters that effect all layers of the current Program.



EDIT:Program Common			
BendRange Up	200 ct		
BendRange Down	-200 ct		
Output Gain	9 dB	Tuning Map	0 None
Category	Piano		
Intonation Map	0 None	Intonation Key	C
Monophonic	On		
Legato	On	MonoSamp XFadeOn	
Portamento	On		
Portamento Rate	70.0 key/s	Portamento Attk	Off
Out Pan	0	Out Pan Mode	+MIDI
Globals	On		
Demo Song	10 Late Bloomer		

◀ MORE PARAMS FX LYR FX COMMON MORE ▶

BendRange Up & BendRange Down

Use these parameters to define how much the pitch will change when you move the Pitch Wheel. Pitch values are set in cents, where 100 cents = 1 half-step (1 semitone).

For both Bend parameters, positive values will cause the pitch to bend up, while negative values will cause the pitch to bend down. Large positive values can cause samples to bend to their maximum upward pitch before the Pitch Wheel is fully up (or down). This will not happen when bending the pitch down.

Output Gain

Use the Output Gain parameter to cut or boost the final gain stage of the post-FX program signal. This is useful for adjusting the overall volume of a program.

Category

This parameter sets the category that the program will be grouped into when you press one of the Category buttons from the Program mode main page.

Intonation Map

The Intonation Map parameter allows you to set a different intonation map for each program. You can edit the currently selected map and save it as a user map by pressing the EDIT button.

Program Edit Mode

The COMMON Page

The Intonation Map parameter works just like the Global mode Intonation Map parameter, except the Intonation Map parameter on the Program Common page only applies to the current program. (The Global mode Intonation Map parameter applies to all programs.) See [Editing Intonation Maps on page 9-13](#) for more details on intonation maps.



Intonation Key

The Intonation Key parameter allows you to set a different Intonation Key for each program. The Intonation Key parameter works just like the Global mode Int Key parameter, except the Intonation Key parameter on the Program Common page only applies to the current program. (The Global Mode Int Key parameter applies to all programs.) See [Editing Intonation Maps on page 9-13](#) for more details on intonation keys.

Tuning Map

Program Tuning Maps can be selected and edited for each Program, to set tuning offsets for each key in cents. (Tuning Map offsets are cumulative with any tuning applied in the keymap editor, sample editor, and elsewhere). You can edit the currently selected map and save it as a user map by pressing the EDIT button.

Program Tuning Maps are primarily used to emulate stretched tuning techniques, which are commonly used for acoustic pianos and other acoustic keyboard instruments. Stretched tunings generally tune notes in the lowest octave increasingly flat, and notes in the highest octave increasingly sharp. For solo piano performances, stretched tunings can make the overtones and harmonics of notes in these lowest and highest octaves sound more in tune with notes in the middle octaves.

Three stretched tuning maps are included, Railsback (a common stretched tuning), Grand Eight Ft (based on a grand piano), and Tines EPiano (based on a common electric piano service manual).

Many of the PC4's factory piano samples and keymaps use equal temperament (non-stretched) tuning by default. Piano keymaps which use equal temperament are named ending with EQT.

Factory piano programs which use EQT keymaps and have one of the included stretched Tuning Maps selected will use a stretched tuning.

Factory piano programs which use EQT keymaps and have Tuning Map set to 0 None will use an equal temperament tuning.

For samples and keymaps which do not use equal temperament tuning, it is possible to edit a user Tuning Map in order to apply equal temperament tuning.

When layering piano with other instruments using equal temperament (non-stretched) tunings, using an equal temperament piano tuning may be preferable so that notes in the lowest and highest octaves sound more in tune with other instruments which use equal temperament tuning. In this case, if a piano program uses equal temperament samples and keymaps, set the Tuning Map to 0 None to use equal temperament tuning.

Monophonic

When the Monophonic parameter is set to "Off", the current edited program is polyphonic—it can play multiple notes at a time.

When the Monophonic parameter is set to "On", the program will play only one note at a time, and the Legato parameter and the four Portamento parameters will appear on the Program Common page. The Monophonic, Legato and Portamento parameters are not available for KB3 programs.

Legato

When the Monophonic parameter is set to "On", the Legato parameter appears. The Legato parameter is useful for emulating legato techniques of various acoustic instruments. When the Legato parameter is set to "On", a played note will trigger a new amplitude envelope only if no other notes in the program are being held. Notes played while other notes are being held will use the previously triggered amplitude envelope of the first note that was played.

Portamento

When the Monophonic parameter is set to "On", the Portamento parameter appears.

When the Portamento parameter is set to "On", notes played in a monophonic Program can glide from the pitch of the previously played note to the pitch of the currently played note.

Portamento is often used in synthesizer lead sounds, or to mimic acoustic instruments like violin and bass, where a pitch glide is achieved by sliding a finger along a vibrating string.

See Portamento Rate (below) to set the Portamento glide speed, and Attack Portamento (below) to set the way that Portamento responds to played notes. See the Mono Sample XFade parameter (below) to improve the sound of Portamento in programs that use multiple samples.

Portamento Rate

When the Portamento parameter is set to “On”, the Portamento Rate parameter appears.

The Portamento Rate parameter determines how fast a note glides from the pitch of one note to the pitch of the next played note. The value selected for this parameter determines how many seconds a note takes to glide one semitone (half-step) toward the pitch of the next played note. For example, at a setting of 12 keys/second the pitch would glide an octave every second. Select a higher value for a faster pitch glide, or a lower value for a slower pitch glide. The list of values is nonlinear; that is, the increments get larger as you scroll to higher values.

Portamento Attk

This parameter toggles between two types of portamento. When set to **On**, the pitch always glides to each new note played from the pitch of the last note played. When set to **Off**, the pitch glides to each new note played only if the last note played is still being held. This is useful when you want only some notes to use portamento.

Mono Sample XFade

When applying portamento to programs that use multiple samples (Acoustic Guitar, for example), the PC4 will play more than one sample root as the pitch glides from the starting pitch to the ending pitch. This may cause a small click at each sample root transition. You can eliminate clicks by setting the Mono Sample XFade parameter to On. When the Mono Sample XFade parameter is set to On, the PC4 performs a crossfade at each sample root transition to eliminate clicks.

Out Pan

Use the Out Pan parameter to adjust the left/right balance of the entire Program output signal (post-FX). Negative values pan the audio signal to the left channel, positive values to the right, and a value of zero pans to the center.

Out Pan Mode

When the Out Pan Mode is set to Fixed, the Out Pan position remains as defined with the Out Pan parameter, ignoring MIDI pan messages. When the Out Pan Mode is set to +MIDI, MIDI pan messages (MIDI 10) will shift the sound to the left or right of the Pan parameter setting. Message values below 64 shift it left, while those above 64 shift it right.

Globals

This parameter affects the control sources LFO2, ASR2, FUN2 and FUN4.

When the Globals parameter is set to **Off**, these control sources are **local**; they affect each note individually in the layers that use them as a control source. They begin operating for each note each time a note in that layer is triggered, and are not affected by other notes.

When the Globals parameter is set to **On**, these control sources become **global**, which means they affect every note in every layer of the current program, they're not specific to any one layer. When these control sources are global, they begin operating as soon as the program is selected. When Globals are on, LFO2, ASR2, and FUNs 2 and 4 will appear on the LFO+ page preceded by the letter G to indicate that they're global.

Local control sources are useful for affecting parameters independently for each note in a layer. Local control sources have the advantage of having a separate copy re-triggered for each note. Their disadvantage is that their parameters must be set separately for each layer if you wish to affect multiple layers.

Global control sources are useful for affecting many parameters in a program uniformly, because they share the same settings on all layers. Their disadvantage is that a separate copy is not re-triggered for each note.

You'll use global control sources when you want to affect all notes in a program uniformly, and local control sources when you want to affect each note independently. For example, a global LFO is useful for controlling amplitude to create a tremolo effect, if you want the effect applied uniformly to all the notes you play. A local ASR is useful for controlling the frequency of a filter sweep, if you want the filter sweep to be independent for each note.

Demo Song

The Demo Song parameter allows you to choose the demo song for the current program. The demo song is a short, pre-programmed song that gives you a demonstration of the program in a musical context. You can play a program's demo song in Program mode by simultaneously pressing the 0/MISC and ENTER buttons.

The Arpeggiator (ARP) Page

Use the Arp page to adjust settings for the Program's Arpeggiator. The Arpeggiator takes note input from the keyboard (or via MIDI) and outputs a rhythmic and/or melodic pattern of MIDI notes. The Arpeggiator can affect both the internal programs and external MIDI instruments.



The Arpeggiator processes notes by playing them repeatedly, and/or transposing them up and down the keyboard. You have control over note output velocity, order, duration, transposition, and more. In Multi Mode, you can assign controllers to control several arpeggiator parameters in real time (see Multi Controller destinations 147, 150-160 and 170-178 in [The Controller Destination List on page 7-20](#)). You can also select and edit patterns for note shifting, velocity shifting, and duration, either as independent patterns, or as a combination of all three in Step Sequencer mode. The Arpeggiator also has several different “latch” settings, which allows the arpeggiator to respond to played notes in different ways, such as continuing to play after you have released the keys.

The SAVE ARP Soft Button

If you have adjusted any Arpeggiator settings, you have the option of saving a new Arp Preset to a User location, where it will be available to use with other Programs and Multis. All settings on the ARP page are saved as part of the arp preset, except for the State and KeyRange parameters, which are stored with the Program/Multi. If you don't save an arp preset, the arp settings will still be saved with the current Program or Multi.

Press the SAVE ARP soft button to initiate a save. You will have the option to select the ID number and name for your Arp Preset.

Arpeggiator Common Parameters

The following common parameters are used by the Arpeggiator in both Classic and Step Sequencer mode.

Arp Preset

Use the Arp Preset parameter to recall factory or user created Arpeggiator settings. An Arp Preset contains settings for all of the parameters on the ARP page (except for the State and KeyRange parameters, which are stored with the Program/Multi). Scrolling through the Arp Presets is an easy way to discover the different possibilities of the arpeggiator, or to find a preset similar to what you want and continue to edit it from there.

You can save your current settings as an Arp Preset by pressing the SAVE ARP soft button. If you select a different Arp Preset before saving your current Arpeggiator settings, the current Arpeggiator settings will be replaced by the settings from the preset without showing a warning. Be sure to save your settings as an Arp Preset if you want to be able to recall them after making additional changes. Even if you don't save the current Arpeggiator settings as an Arp Preset, the most recent settings will always be saved with the Program or Multi when the Program or Multi is saved. Changing any of the Arp parameters will change the Preset to "0 Edited Arp", to indicate that the previous preset settings are no longer being used.

State

Use the State parameter to turn the Arpeggiator On or Off. This corresponds to the ARP button in the front panel ARPEGGIATOR section. In a Multi, this parameter can also be controlled using Controller destination 147 (Arp On/Off).

Arp Mode

The two Arpeggiator modes, Classic and Step Sequencer, offer different means of shaping and editing Arpeggiator patterns. Depending upon this mode, the ARP page will provide access to different options and editable patterns.

In **Classic** mode, the ARP page will offer algorithmic options, as well as independent note-Shift, Velocity and Duration patterns. These patterns are editable. See [Arpeggiator Classic Mode Parameters on page 3-27](#) for details on Classic mode parameters.

In **Step Sequencer** mode, you can edit sequences step-by-step, specifying Note, Velocity, Duration and Beat for each step in a sequence. See [Arpeggiator Step Sequencer Mode Parameters on page 3-34](#) for details on Step Sequencer mode parameters.

Arp Mode can also be set to **Off**. In Multi Mode, set the Arp Mode to Off for any Zones which you don't want to control with the ARP and LATCH buttons.

Program Edit Mode

The Arpeggiator (ARP) Page

Tempo

Use the Tempo parameter to set the arpeggiator tempo in beats-per-minute. This parameter also sets the tempo for tempo synced effects and LFOs. Use the Keypad, Alpha Wheel, or Previous/Next buttons to set a tempo that will be saved with the program.

You can also set the tempo to System by scrolling below 20 BPM, or typing -1 followed by the ENTER button. When Tempo is set to System, the arpeggiator will use the system tempo. System tempo is useful when you wish to set a tempo that will be used by many programs. Programs set to System are not saved with a set tempo, and will always use the global system tempo. To set the system Tempo, use the TEMPO section of the front panel. Press the TAP button a few times at the desired rate, or use the TEMPO knob. For details on system tempo, see [TEMPO on page 9-30](#).

In Multi Edit Mode, the arp Tempo parameter is not shown, and the arpeggiator tempo is determined by the Tempo parameter on the Common page.

Latch

The Latch parameter allows you to control how and when notes played on the keyboard (or via external MIDI) will be arpeggiated. For example, some latch settings allow notes to continue arpeggiating after keys have been released (these are called latched notes), and some settings only arpeggiate certain notes. **Keep in mind, notes played outside of the Arp KeyRange are never latched or arpeggiated.**

Some Latch settings require using the Latch switch. The Latch switch can be controlled by the LATCH button in the front panel ARPEGGIATOR section, or by a switch pedal by setting one of the SW Override parameters to Arp Latch on the Global Mode Main 2 page (see [Switch Pedal Overrides on page 9-14](#)). In Multi Mode, you can also control the Latch switch by assigning a switch to destination 157 (Latch Sustain) or 158 (Latch2 Sost) (values 0-63 = off, 64-127 = on).

Each of the Latch settings are described below.

Keys: If the Latch switch is turned off, notes are arpeggiated only when keys are held. As you hold different notes, they get added to the arpeggiation, and as you release notes, they get taken out.

When Latch is set to Keys, the LATCH button in the front panel ARPEGGIATOR section can be used to latch played notes so that they will arpeggiate even after they are released.

In Program Edit Mode, when the Keys setting is selected, the **Latch Type** parameter appears. The Latch Type parameter determines the behavior of the LATCH button in the front panel ARPEGGIATOR section. When the Latch Type parameter is set to Latch Sustain, if the Latch switch is turned on, any played notes will become latched. When the Latch Type parameter is set to Latch2 Sost, any played notes will become latched, **only** when the Latch switch is turned on while notes are held. Latched notes will arpeggiate until the Latch switch is turned off.



Note: In Multi Edit Mode, when the Keys setting is selected, the Latch Type parameter does

not appear. In Multi Edit Mode, the behavior of the LATCH button in the front panel ARPEGGIATOR section is determined per Zone on the Controls page of each Zone. For details see [“Switch Controllers” on page 7-13](#).

Overplay: Notes are arpeggiated **only** when the Latch switch is turned on while notes are held. Overplay latches any keys that are being held when the Latch switch is turned on. Latched keys continue arpeggiating after they are released until the Latch switch is turned off. Any notes that you play after the Latch switch is turned on do not get arpeggiated.

Arpeg: Notes are arpeggiated **only** when the Latch switch is turned on while notes are held. Arpeg latches any keys that are being held when the Latch switch is turned on. Latched keys continue arpeggiating after they are released until the Latch switch is turned off. Any notes that you play after the Latch switch has been turned on become part of the arpeggiation, and they drop out of the arpeggiation as soon as you release them.

Add: Notes are arpeggiated **only** when the Latch switch is turned on while notes are held. Add latches any keys that are being held when the Latch switch is turned on, and also latches any notes played after this. Latched keys continue arpeggiating after they are released until the Latch switch is turned off.

Auto: Every note you play is automatically latched, and the Arpeggiator runs as long as you hold at least one arpeggiated note. As long as you keep holding on at least one note (it doesn't have to be the same note the whole time), every note you play in the arpeggiation range gets latched.

Autohold is similar to Auto. Holding at least one arpeggiated note on and playing other notes latches those notes. Unlike in Auto mode, if you stop holding at least one arpeggiated note on, the arpeggiation continues playing (although you can't latch any more notes). In this case, if you strike another key within the arpeggiation range, you start a new arpeggiation sequence. Autohold is useful for arpeggiating chords: when you play a chord, it gets latched, and continues arpeggiating after you release the chord. When you play another chord, the previous chord gets unlatched, and the new one gets latched. You can use the front panel ARP button to stop arpeggiation at any time.

1NoteAuto is similar to Autohold, except only the last note played is latched (even if previously played notes are still being held). 1NoteAuto is specifically designed for use with Shift Patterns (see [“Shift Pattern” on page 3-27](#)) because Shift Patterns are designed to be played from one note at a time (though you can use 1NoteAuto without a Shift Pattern as well). Using 1NoteAuto ensures that Shift Patterns will sound correct by only allowing one note at a time to trigger the pattern. You can use the ARP button in the front panel ARPEGGIATOR section to stop arpeggiation at any time.

1NoteAutoLow and **1NoteAutoHi** are also designed for use with Shift Patterns. They work similarly to 1NoteAuto, except 1NoteAutoLow always latches the lowest note when holding multiple notes, and 1NoteAutoHi always latches the highest note when holding multiple notes. You can also use these latch types without a Shift Pattern if desired. You can use the ARP button in the front panel ARPEGGIATOR section to stop arpeggiation at any time.

Limit Option

This parameter determines what the Arpeggiator does when it has shifted the currently arpeggiated notes up (or down) to the value set by the Shift Limit parameter.

Stop causes the Arpeggiator to stop when it reaches the shift limit.

Reset causes the Arpeggiator to return to its original pitch and repeat the cycle of notes.

Unipolar means that after a note reaches the shift limit, the note is shifted in the opposite direction, until it reaches the original pitch, where it reverses direction again. If Shift Amount is set to a positive value, a note will never be shifted below its original pitch. If Shift Amount is set to a negative value, a note will never be shifted above its original pitch.

Bipolar means that after a note reaches the shift limit, the note is shifted in the opposite direction, until it reaches the shift limit in the *opposite* direction, where it reverses again.

FloatRst (float reset) means that when the Arpeggiator reaches the shift limit, it looks at the first note that would exceed the shift limit, and calculates the interval between that note and the shift limit. It then restarts the cycle of latched notes, transposing the entire cycle by the interval it just calculated, then shifting each subsequent cycle by the value of Shift Amount, until it reaches the shift limit again.

Here's a very simple example. Suppose that the only note in the Arpeggiator cycle is C₄, Shift Amount is 4 (a third), and Shift Limit is 7 (so notes won't get shifted above G₄). The Arpeggiator plays C₄, then E₄. The next note should be G[#]₄, but that's above the shift limit—so the arpeggiator calculates the difference between that G[#]₄ and the shift limit (G₄): one semitone. It adds that difference to the original starting note (C₄) and plays that note next—C[#]₄. The next note (F₄) is within the shift limit, but the next note (A₄) isn't, so it gets translated into D₄—and so on.

FloatUnip uses the same concept as FloatRst and applies it to Unipolar mode: when the Arpeggiator reaches the shift limit, it calculates the difference between the next note and the limit, and transposes the next cycle of notes down by that interval, then shifts each subsequent cycle down until it reaches the original pitch.

FloatBip is similar to FloatUnip, but the downward shift limit isn't the original pitch, it's the negative of the Shift Limit value.

Key Range (Low Key and High Key)

The Arpeggiator processes notes within the range of these parameters. Notes outside the specified range play normally, and do not become part of the arpeggiation sequence. When the Low Key or High Key parameter is selected, you can easily set the value by holding the ENTER button and striking the desired key. Key Range is not saved with each Arp Preset, but instead is saved as part of each program (or Multi Zone). This allows you to try different presets while maintaining the same Key Range.

Arpeggiator Classic Mode Parameters

Beats

The Beats parameter sets the number of notes per beat. The tempo is based on quarter notes. Therefore, if you set Beats to 1/4, you will get one note per beat of the clock. At 1/16, you will get 4 notes per beat, and so forth. The maximum value is 96 notes per beat (1/384), but at most tempos, divisions smaller than 1/64 will sound pretty much the same.

To find a Beats value, multiply the notes you want per beat by 4. For example, 4 notes per beat (16th notes) would be $4*4=16$, a Beats value of 1/16. Three notes per beat (8th note triplets) would be $3*4=12$, a Beats value of 1/12. Six notes per beat (16th note triplets) would be $6*4=24$, a Beats value of 1/24.

Shift Mode

Use the Shift Mode parameter to set how the arpeggiator will shift the pitch of played notes. The **Alg** (algorithm) setting will let you create note sequences based upon a fixed Shift Amount. When you select **Patt** (pattern), the **Shift Pattern** parameter will appear, allowing you to select a preset or user defined shift pattern. See Shift Pattern below for details.

Shift Limit

When the Shift Amount parameter is set to a value other than 0, **Shift Limit** determines how far up or down the Arpeggiator can shift the arpeggiated notes. Try setting Shift Limit to 12 or 24 to create an arpeggio that repeats the same pattern of notes in different octaves. This works well when Shift Amount is set to 12 or when a Shift Pattern is selected.

Shift Amount

When the Shift Mode is set to Alg, **Shift Amount** appears. Shift Amount determines how much transposition will occur for each cycle of notes. Try setting Shift Amount to 12, and Shift Limit to 12 or 24 to create an arpeggio that repeats the same pattern of notes in different octaves.

Shift Pattern

When Shift Mode is set to Pattern, the **Shift Pattern** parameter appears, which allows you to select a step sequence for arpeggiator note patterns. The note number of each played key is shifted according to a sequenced pattern, thus "Shift Pattern." There are pre-programmed shift patterns including many useful chords, intervals, and rhythms. You can also create a custom user pattern using the pattern editor (see below for details).

Shift Pattern steps are played back at the rate set for **Beats**. Keep in mind that Shift Patterns are affected by every parameter on the ARP page, which can be the cause of unexpected variation, or a way to add interesting variation to a pattern.

Program Edit Mode

The Arpeggiator (ARP) Page

Shift Patterns are most easily used and understood when triggered by only one key at a time. One way to prevent triggering from multiple keys is to use one of the Latch types 1NoteAuto, 1NoteAutoLow, or 1NoteAutoHi when using a shift pattern. Triggering shift patterns from one key allows the pre-programmed patterns to sound like what you would expect from their names (otherwise the results can be unpredictable). If no other keys are playing, patterns will start over each time a key is pressed (there are some exceptions to this when using Arpeggiator Latch settings other than “Keys,” though a newly triggered pattern will always start at step 1).

Editing Shift Patterns

You can edit the highlighted pattern by pressing the EDIT button. You can create a new user pattern by editing an existing pattern and saving it to a user ID.



In the Shift Pattern editor, pressing STEP- removes the last step in the list, pressing STEP+ inserts a new note step at the end of the list. Use the cursor to move between pattern steps, use the alpha wheel, alphanumeric pad, or plus/minus buttons to enter the note shift amount for each step. You can set a step to a value of “none” by entering -127 and then scrolling down one more step. A step with the value “none” causes the arpeggiator to play nothing for that step, allowing you to create rhythmic patterns by using “none” to leave spaces.

Use the CHANNEL/LAYER/ZONE/TRACK buttons to change the direction in which pattern steps are played (indicated by **Up**, **Down**, or **Flat** on the right of the top line). With pattern direction set to **Up**, the pattern plays starting at step one and moving up through each step towards step 48. With pattern direction set to **Down**, the pattern starts at step one, but then moves to the last step and continues to move backwards through the steps down towards step 1 in the octave below the first note played. When the pattern direction is set to Up or Down, the pattern will repeat transposed in the next higher or lower octave (limited by the ARP page Shift Limit parameter). Patterns set to **Flat** play without transposition, in which case the Shift Limit parameter can be used to restrict note range.

To save an edited pattern, press the front panel **Save** button to view the save dialog and select a user ID. You can also rename the pattern if desired. Press DELETE to delete a user pattern from memory. Press **Exit** to return to the ARP page.

Play Order

When the Shift Mode is set to Alg, **Play Order** appears. Play Order determines the order in which the arpeggiator plays notes.

Played causes them to play back in the chronological order in which you played them.

Upwards means that notes play in ascending pitch order.

Downwards means that notes play in descending pitch order.

UpDown causes notes to play from lowest pitch to highest, then from highest pitch to lowest, repeating the cycle until you stop the arpeggiation. The notes at the very top and very bottom only play once.

UpDownRep is similar to UpDown, except that the notes at the top and bottom play *twice* when the Arpeggiator reverses direction.

Random plays the notes in random order.

Shuffle plays them at random, but keeps track of the notes so that no note repeats until all of the others have played.

Walk is a “random walk” order: each successive note is either the next or previous note (in chronological order). For example, suppose you’ve played four notes—G⁴, B⁴, D⁵, and F⁵—in that order. The first note the Arpeggiator plays is the G⁴. The second note will be either B⁴ (the next note chronologically), or F⁵ (the “previous” note chronologically—that is, the last arpeggiated note). If the second note is B⁴, the third note will be either D⁵ or G⁴. If the second note is F⁵, the third note will be either G⁴ or D⁵.

Simultaneous makes the Arpeggiator repeat each note simultaneously. If you play a C and hold it while you play an E and a G, the Arpeggiator will play all three notes at the same time and at the same tempo. **Simultaneous** also works well with Shift and Limit, allowing you to shift multiple notes simultaneously.

Velocity

Velocity sets the attack velocity of the played notes.

With Velocity set to **First**, all notes play at the velocity of the first played note.

With Velocity set to **Played**, each note repeats with the same velocity you played it at.

With Velocity set to **Last**, all notes play at the velocity of the most recently played note.

With Velocity set to **Aftertouch**, the velocities are controlled by keyboard pressure: as you hold and push down on any key, the velocities get higher, and as you ease up they get lower.

With Velocity set to **MIDI109**, all notes play with the same velocity. The default MIDI109 velocity is 100. In Multi Mode, you can control the velocity in real-time by assigning a controller to destination 109.

Program Edit Mode

The Arpeggiator (ARP) Page

With Velocity set to **Fixed**, all notes play with the same velocity. The Velocity Fixed field appears, which allows you to set a specific velocity. In Multi Mode, you can control the velocity in real-time by assigning a controller to destination 175 VelFixed.

When you select **Pattern**, the **Velocity Patt** parameter will appear, allowing you to select a preset or user defined velocity pattern. See Velocity Patt below for details.

The Velocity Modes **Human1** through **Human4** randomly change played note velocity within a range in order to make arpeggiation sound more human like, with each note varying slightly in velocity. The Human settings use the velocity received from the first note played as the center of the randomization range. Each note of the arpeggiator will randomly choose a velocity within the given range. (See the table below for velocity ranges.)

The Velocity Modes **Chimp1** through **Chimp4** function in a similar fashion to the Human settings (see above). Like the Human settings, the Chimp settings randomly change played note velocity within a range, but the Chimp settings have larger randomization ranges. The Chimp settings use the velocity received from the first note played as the center of the randomization range. Each note of the arpeggiator will randomly choose a velocity within the given range. (See the table below for velocity randomization ranges.)



Note: For Human and Chimp modes, if the velocity of the first played note is low enough that the selected randomization range could result in a velocity of zero, some notes may have a velocity of zero and therefore produce no sound.

Velocity Setting	Velocity Randomization Range
Human1	± 3
Human2	± 6
Human3	± 10
Human4	± 15
Chimp1	± 25
Chimp2	± 35
Chimp3	± 50
Chimp4	± 64

Velocity Modes MissNotes1 through MissNotes9 makes the PC4 randomly miss playing a percentage of inputted notes. See the table below for percentages and their equivalent settings. Each of these settings also randomly changes some of the inputted velocities in a range of ± 5 , with the purpose of simulating a more human played sound.



Note: Missed Notes are actually output as notes with a velocity of zero.

Velocity Setting	Approximate % of Notes Missed
MissNotes1	% 10
MissNotes2	% 20
MissNotes3	% 30
MissNotes4	% 40
MissNotes5	% 50
MissNotes6	% 60
MissNotes7	% 70
MissNotes8	% 80
MissNotes9	% 90

Velocity Patt

When Velocity is set to **Pattern**, the **Velocity Patt** parameter appears, which allows you to select a step sequence for arpeggiator velocity patterns. A Velocity Pattern shifts the velocity of each arpeggiated note according to a sequenced pattern. Select a factory pattern, or create a custom user pattern using the pattern editor (see below for details).

Velocity Patterns use the velocity received from the first note played as the center position to shift velocities up or down from. Velocity Pattern steps are played back at the rate set for **Beats**. Rhythms can be created by using velocity values of -127 or “none” to leave rests in the arpeggiation.

If no other keys are playing, patterns will start over each time a key is pressed (there are some exceptions to this when using ARP Latch parameters other than “Keys,” though a newly triggered pattern will always start at step 1). When triggering velocity patterns from more than one key at a time, each consecutive step of the pattern shifts the velocity from a different inputted key, the order of which is decided by the Play Order parameter on the ARP page.

Program Edit Mode

The Arpeggiator (ARP) Page

Editing Velocity Patterns

You can edit the highlighted pattern by pressing the EDIT button. You can create a new user pattern by editing an existing pattern and saving it to a user ID.

Each pattern can have up to 48 steps, and each step can shift velocities by ± 127 steps. You can insert a step with a value of “none” by entering -127 and then shifting down one more step. A step with the value “none” causes the arpeggiator to play nothing for that step, allowing you to create rhythmic patterns by using “none” to leave spaces. Pressing STEP- removes the last step in the list, pressing STEP+ inserts a new velocity step at the end of the list (the pattern editor remembers the values of removed steps until you save or exit). Use the navigation buttons to move between pattern steps, use the Alpha Wheel, or Previous-/Next+ buttons to enter the velocity shift amount for each step.



EDIT:Arp Velocity Pattern			
Step 1	0	Step 13	-1
Step 2	16	Step 14	-15
Step 3	32	Step 15	-33
Step 4	16	Step 16	-19
Step 5	0	Step 17	-2
Step 6	-16	Step 18	16
Step 7	-32	Step 19	33
Step 8	-16	Step 20	18
Step 9	1	Step 21	0
Step 10	18	Step 22	-16
Step 11	34	Step 23	-28
Step 12	14	Step 24	-12



Note: For patterns with negative velocity values, if the velocity of the first played note is low enough that a pattern step could result in a velocity of zero, some notes may have a velocity of zero and therefore produce no sound.

To save an edited pattern, press the front panel **Save** button to view the save dialog and select a user ID. You can also rename the pattern if desired. Press **DELETE** to delete a user pattern from memory. Press **Exit** to return to the ARP page.

Duration Mode

Use the Duration Mode parameter to set how the arpeggiator will control the duration of played notes. When Duration Mode is set to **Fixed**, the Duration parameter appears which allows you to set a fixed duration that will be applied to all arpeggiated notes. See the Duration section below for details. When **Pattern** is selected, the **Duration Pattern** parameter will appear, allowing you to select a preset or user defined duration pattern. See the Duration Pattern section below for details.

Duration

Duration determines how long each arpeggiated note plays based on the current arpeggiator Beats value. 100% means that a note sustains until the next one sounds—very legato. 50% means that the note fills half the space between itself and the next note. The lowest value is 0%—*staccatissimo*. This parameter has no effect on percussion sounds or other sounds whose duration is fixed.

Duration Patt

When Duration Mode is set to **Pattern**, the **Duration Patt** parameter appears, which allows you to select a step sequence for arpeggiator duration patterns. A Duration Pattern sets the duration of each arpeggiated note according to a sequenced pattern. Duration Pattern steps are played back at the rate set for **Beats**. The duration of each note is a percentage of the current arpeggiator Beats value. Select a factory pattern, or create a custom user pattern using the pattern editor (see below for details).

Editing Duration Patterns

You can edit the highlighted pattern by pressing the EDIT button. You can create a new user pattern by editing an existing pattern and saving it to a user ID.

Each step can have a duration from 0-100% of the current arpeggiator Beats setting. Each pattern can have up to 48 steps. Pressing STEP- removes the last step in the list, pressing STEP+ inserts a new note step at the end of the list (the pattern editor remembers the values of removed steps until you save or exit). Use the navigation buttons to move between pattern steps, use the Alpha Wheel, alphanumeric pad, or Previous-/Next+ buttons to enter the duration amount for each step.

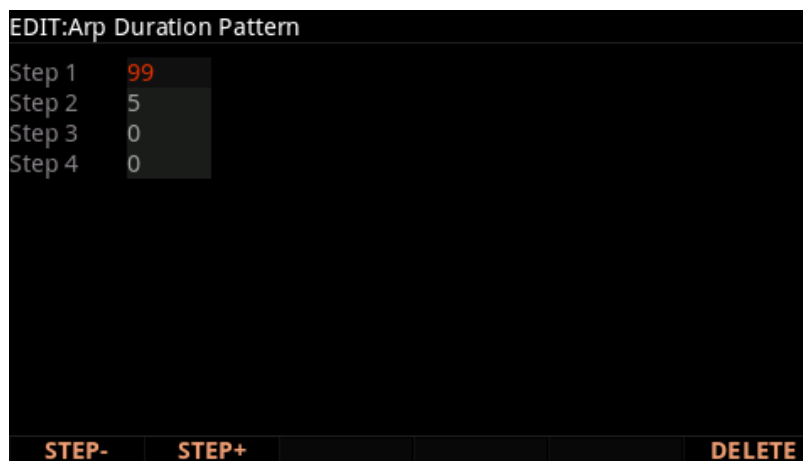

To save an edited pattern, press the front panel Save button to view the save dialog and select a user ID. You can also rename the pattern if desired. Press DELETE to delete a user pattern from memory. Press the Exit button to return to the ARP page.

Arpeggiator Step Sequencer Mode Parameters

In Step Sequencer mode, the ARP page will give you the ability to create a unique Arpeggiator pattern step-by-step.

EDIT:Program Arpeggiator						
Arp Preset	3 Happy 4th			State	Off	
Mode	Step Sequencer	Tempo	120.00			
Latch	Keys	Limit Option	Unipolar			
Key Range	C -1 ... G 9					
Number Steps	6					
Step#	1	2	3	4	5	6
Note	0	-7	9	12	5	-7
Veloc	0	-20	-30	0	-20	-30
Durat	100	74	5	100	46	9
Beats	1/16	1/16	1/16	1/16	1/16	1/16
SAVE ARP		ARP		CC SEQ		

Select a parameter using the up/down navigation buttons. To change steps, select the Step# parameter, then press the left or right navigation buttons.

Colored oval graphics provide a quick visual interpretation of the Step Sequence:

- Color = **Note** number.
- Height = **Velocity** level.
- Width = **Duration**.
- The line under each oval changes length depending on the **Beats** value for the current step.

Number Steps

Use the Number Steps parameter to set the number of steps in the current sequence.

Step#

The Step# parameter shows the number of each step in the sequence, and can be used to navigate between the steps.

Note

Note values create the shift pattern for the Step sequence. Notes are specified in half-steps from the last latched note (represented as 0). Thus, this series of notes: 0, 4, 7 will play a triad in sequence. Note values can range from -128 to +127, with negative numbers shifting below the latched note.

Veloc (Velocity)

Veloc (Velocity) values shift the velocity of each step up or down from the last latched note. Velocity can be shifted -127 to +127 from the original value of the last latched note.

Durat (Duration)

Durat (Duration) determines how long each step is sustained, based on the Beats value of each step. The duration range is 0-100, which represents a percentage of the Beats value of each step. A setting of 100 will sustain the note for the entire length of the step.

Beats

Beats sets the length of time between each step in the sequence, which allows you to alter the rhythm of a sequence. Beats is set in fractions of a 4 beat measure, whose rate is set by the Tempo parameter. A step with Beats set to 1/4 will play a quarter note based on the current Tempo setting.

To find a Beats value, multiply the notes you want per beat by 4. For example, 4 notes per beat (16th notes) would be $4 \times 4 = 16$, a Beats value of 1/16. Three notes per beat (8th note triplets) would be $3 \times 4 = 12$, a Beats value of 1/12. Six notes per beat (16th note triplets) would be $6 \times 4 = 24$, a Beats value of 1/24.

The CC Sequencer (CC SEQ) Page

The CC Sequencer allows you to rhythmically modulate up to 4 program parameters (such as filter frequency) based on preset or user patterns. CC is short for continuous controller, which is a type of MIDI message that can be used to control assigned parameters. The CC Sequencer can affect both internal programs and external MIDI instruments.

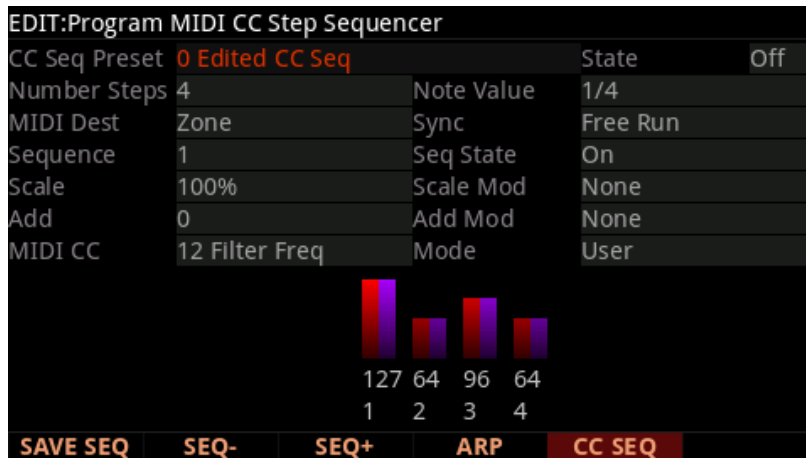

CC Seq Preset

Use the CC Seq Preset parameter to recall factory or user created CC Sequencer settings. A CC Seq Preset contains settings for all of the parameters on the CC SEQ page (except for the State parameter, which is stored with the Program/Multi). Scrolling through the CC Seq Presets is an easy way to discover the different possibilities of the CC Sequencer, or to find a preset similar to what you want and continue to edit it from there.

You can save your current settings as a CC Seq Preset by pressing the SAVE SEQ soft button. If you select a different CC Seq Preset before saving your current CC Sequencer settings, the current CC Sequencer settings will be replaced by the settings from the preset without showing a warning. Be sure to save your settings as a CC Seq Preset if you want to be able to recall them after making additional changes. Even if you don't save the current CC Sequencer settings as a CC Seq Preset, the most recent settings will always be saved with the Program or Multi when the Program or Multi is saved. Changing any of the CC Sequencer parameters will change the Preset to "0 Edited CC Seq", to indicate that the previous preset settings are no longer being used.

State

Use the State parameter to turn the CC Sequencer On or Off. When selecting and playing programs in Program Mode, you can control the State parameter by pressing the CC SEQ soft button. In a Multi, this parameter can also be controlled with Controller Destination 148 (CC Seq On/Off).

Number Steps

Use the Number Steps parameter to set the number of steps in the sequence.

Sync

When the State parameter is set to On, the Sync parameter determines when the CC sequence will re-start.

When the Sync parameter is set to **Free Run**, the sequence begins playing as soon as the program is selected, and it restarts whenever it reaches the end of the sequence.

When the Sync parameter is set to **Every Note**, the sequence begins playing as soon as the program is selected, and it restarts whenever it reaches the end of the sequence, or whenever a new note is played.

When the Sync parameter is set to **All Keys Up**, the sequence begins playing as soon as the program is selected, and it restarts whenever it reaches the end of the sequence, or whenever all keys have been released.

When the Sync parameter is set to **Arp**, the sequence begins playing only when the program's arpeggiator is playing, and it restarts whenever it reaches the end of the sequence.

When the Sync parameter is set to **Arp with Reset**, the sequence begins playing only when the program's arpeggiator is playing, and it restarts whenever it reaches the end of the sequence, or whenever the program's arpeggiator restarts its sequence.

The **AnyOther CCSeq** setting only applies to Multi Mode. When the Sync parameter is set to AnyOther CCSeq, the sequence begins playing as soon as the Multi is selected, and it restarts whenever it reaches the end of the sequence, or whenever a CC Sequence for a program in another Zone begins or restarts.

Note Value

The Note Value parameter sets the number of steps that will be played per beat. The tempo is based on quarter notes. Therefore, if you set Note Value to 1/4, you will get one step per beat of the clock. At 1/16, you will get 4 steps per beat, and so forth.

MIDI Dest

The MIDI Dest parameter sets the MIDI destination for the CC messages generated by the CC Sequencer. You can send CC messages to a PC4 Program, to the MIDI Out ports, to the USB port, or to any combination of these destinations.

By default, CC messages are sent to all possible destinations. When using the PC4 to control or layer with external MIDI instruments, you may wish to send CC messages only to certain destinations.

In Program Mode, when the MIDI Dest parameter is set to Zone, the CC messages will be sent to the PC4 Program and to the MIDI and USB ports.

In Multi Mode, when the MIDI Dest parameter is set to Zone, the CC messages will be sent to the destination set by the Zone's Main page Destination parameter.

Seq State

The CC Sequencer can play 4 simultaneous sequences which can each control a different parameter or CC number. Use the Seq State parameter to turn the selected sequence On or Off.

Sequence

The CC Sequencer can play four simultaneous sequences which can each control a different parameter or CC number. Use the Sequence parameter to select one of four sequences to edit. You can also use the SEQ- and SEQ+ soft buttons to select one of the four sequences.

Each of the four sequences uses the same settings for the State, Number Steps, Sync, Note Value, and MIDI Dest parameters. All other CC Sequencer parameters can be adjusted independently for each of the four sequences.

Scale

Use the Scale parameter to change the range of CC values sent by the sequence (in combination with the Scale Mod, Add, and Add Mod parameters). The Scale parameter multiplies the CC values sent from the sequence. CC messages are limited to sending values from 0-127, even if the Scale and Add parameters are set to produce values outside of this range.

Each step in a CC Sequence can send CC values 0-127. These values can be multiplied by the percent value of the Scale parameter in order to change the range of CC values. For example:

When when Scale is set to 100% the sequence can send CC values 0-127.

Scale values 1-99% make the sequence send a smaller range of CC values. When Scale is set to 50% the sequence is limited to sending CC values 0-63.

Scale values 101-200% multiply each sequencer step CC value to send higher CC values. For example, when Scale is set to 200% a CC sequencer value of 62 will be sent as 126.

Scale Mod

Use the Scale Mod parameter to change the range of CC values sent by the sequence using a physical controller (in combination with the Scale, Add, and Add Mod parameters).

The selected physical controller will use values 0-127 to multiply the CC values sent from the sequence by 0%-200%.

Add

Use the Add parameter to change the range of CC values sent by the sequence (in combination with the Scale, Scale Mod, and Add Mod parameters). The Add parameter adds a value to the CC values sent from the sequence. CC messages are limited to sending values from 0-127, even if the Scale and Add parameters are set to produce values outside of this range.

Add Mod

Use the Add Mod parameter to change the range of CC values sent by the sequence using a physical controller (in combination with the Scale, Scale Mod, and Add parameters).

The selected physical controller will use values 0-127 to add -127 through 127 to the CC values sent from the sequence.

MIDI CC

Use the MIDI CC field to select a MIDI CC number and/or assigned program parameter to control with a CC Sequence. If a MIDI CC number is assigned to a program parameter, the program parameter name will be shown next to the CC number (for example “12 Filter Freq”).

Mode

Use the Mode parameter to select a preset or user pattern of CC Sequence steps.

When the Mode parameter is set to **User**, the user sequence is displayed. The CC value of each step is shown as a number as well as represented by the height of a red and purple bar. Use the navigation buttons to select each step and adjust each CC value. For each step, the purple bar shows an approximation of the step value that will be sent after the Scale and Add parameters have been applied.

The other Mode parameter settings each display a preset 16 step sequence. Each step of the sequence has a red dot representing a CC value from 0 to 127.

Patterns with Random or Rand in the name will produce random values for each step. The possible range of random values for each step is shown by white arrows.

The SAVE SEQ Soft Button

If you have adjusted any CC Sequencer settings, you have the option of saving a new CC Seq Preset to a User location, where it will be available to use with other Programs and Multis. All settings on the CC SEQ page are saved as part of the CC Seq preset, (except for the State parameter, which is stored with the Program/Multi). If you don't save an CC Seq preset, the CC Sequencer settings will still be saved with the current Program or Multi.

Press the SAVE SEQ soft button to initiate a save. You will have the option to select the ID number and name for your CC Seq preset.

The KEYMAP Page

Use the Keymap Page to select keymaps for the current layer of the Program, as well as other keymap parameters. A keymap is a group of samples that can be played by the current layer.

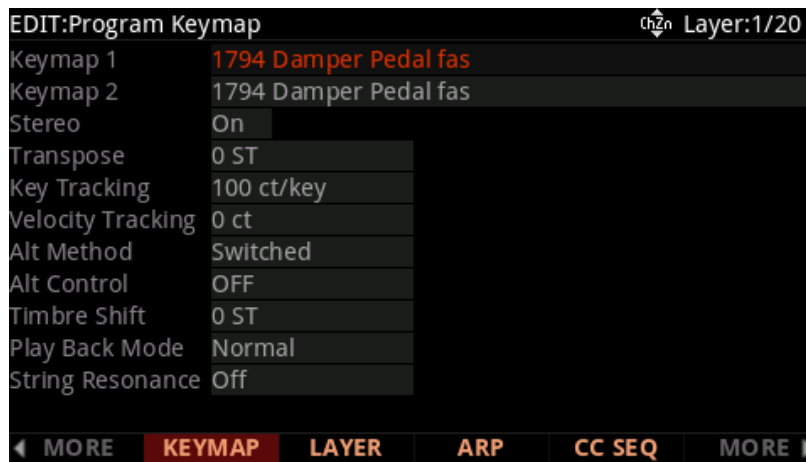

Keymap, Keymap 1, Keymap 2

Assign a keymap to the current layer. Keymaps are collections of samples assigned to note and velocity ranges. With the Keymap parameter selected, press the EDIT button to enter the Keymap editor (see [Ch. 5 Keymap and Sample Editing](#) for details).

When a DSP oscillator is being used as a layer sound source on the ALG page, the layer's current keymap will apply the volume adjustment value of each sample in the keymap to each note played by the oscillator within those sample keyranges. To prevent this, select Keymap 999 Silence.

When a DSP oscillator is being used as a layer sound source on the ALG page, and a layer's Amp Envelope Mode is set to Natural, the natural envelope of each sample in the layer's current keymap will be applied to each note played by the oscillator within those sample keyranges. To prevent this, select Keymap 999 Silence or set Amp Envelope Mode is set to User.

Stereo

Use the Stereo parameter when using stereo samples. When the Stereo parameter is set to **On**, the Keymap 1 and Keymap 2 parameters appear. The KEYMAP page parameters will affect both keymaps. When the Stereo parameter is set to **On**, the OUTPUT page for the current layer will show an additional Pan parameter.

The PC4 contains both stereo and mono samples. Keymaps designed for stereo use are labeled with names beginning with “Stereo” or ending in “Left,” “Right,” “L,” or “R.” For stereo keymap playback, set Stereo to “On” and assign corresponding Left and Right keymaps to Keymap 1 and Keymap 2 respectively. For keymaps beginning with “Stereo,” assign the same keymap to both Keymap 1 and Keymap 2. If you select the same keymap for Keymap 1 and Keymap 2, the PC4 automatically uses the left side for Keymap 1 and the right side for Keymap 2.

Once you have the keymaps assigned, go to the OUTPUT page and set the panning for each keymap as desired.

If you’re not using stereo samples, you should set this parameter to Off.

Transpose

Use the Transpose parameter to transpose the current keymap.

Key Tracking

Use the Key Tracking parameter to set the pitch interval between each keyboard key. The default value of 100 cents gives you the normal semitone (half-step) interval between each note (a cent is a hundredth of a semitone). Higher values increase the interval; lower values decrease it. Negative values will cause the pitch to decrease as you play higher notes.

The Key Tracking parameter on the KEYMAP page works in conjunction with Pitch KeyTrk parameter on the DSP CTL page. Unless you’re looking for nonstandard note intervals, the values of these two parameters should add up to 100 cents.

Velocity Tracking

Use the Velocity Tracking parameter to change the pitch of the keymap based on velocity. Different attack velocities will play different pitches of the sample root assigned to each note range. If the pitch change is great enough, the next higher or lower sample root will be played, which in some cases (many drum programs, for example) will play an entirely different sound. Positive values will play higher pitches of the sample root as you play higher attack velocities, while negative values will play lower pitches as you play higher attack velocities.

Alt Method

Each sample root in a keymap can have an alternate sample start point. The sample start points in the selected keymap can be varied between the original and alternate start point by using an assigned physical controller or other control source. This can be useful for emulating legato playing of acoustic instrument sounds, by skipping the initial attack section of samples for legato notes.

When the Alt Method parameter is set to **Switched**, the PC4 will use the Alt point as the sample start point when the assigned controller is at a value greater than 64. When Alt Method is set to **Continuous**, the sample start point will vary between the original and alternate start point depending on the value of the assigned controller.

Alt Control

Each sample root in a keymap can have an alternate sample start point. The sample start points in the selected keymap can be varied between the original and alternate start point by using an assigned physical controller or other control source. This can be useful for emulating legato playing of acoustic instrument sounds, by skipping the initial attack section of samples for legato notes.

Use the Alt Control parameter to select a control source that will adjust the sample start point.

Emulating Legato Play

If you place the Alt point after the initial attack transients of a sample, you can use the Alt Switch to emulate legato playing in an acoustic instrument, by skipping the initial attack section of samples for legato notes.

Setting the Alt Control parameter to Chan St (Channel State) will cause the alternate sample start point to be used whenever another note is already being held. (Chan St sends a value of 127 whenever at least one note is being held in the program's MIDI channel.) This allows non-overlapping notes to use the sample's original start point, while overlapping notes will use the alternate start point.

Timbre Shift

This parameter works only on multi-sample keymaps, and changes the root selection for each key you play. A timbre-shifted note retains its original pitch, but its harmonics are those of the same timbre at a higher or lower pitch. Positive values for this parameter tend to brighten a sound, while negative values darken.

For example, if you shift the timbre up 4 semitones, playing C 4 will result in the *pitch* C 4, but will actually play the sample normally assigned to G# 3 with its pitch tuned up four semitones. This will increase the playback rate of the sample, so although the pitch remains normal, the timbre is brighter. You'd get the same effect by setting the Transpose parameter on the KEYMAP page to -4 semitones, then setting the Pitch parameter on the DSP CTL page to +4 semitones.

Playback Mode

Setting Playback Mode to Normal plays samples in the selected keymap from their start point to their end point.

Setting Playback Mode to Reverse plays samples in reverse, from their end point to their start point.

Setting Playback Mode to BiDirect (bidirectional) causes the samples to loop infinitely, alternating between normal and reversed playback.

Setting Playback Mode to Noise replaces the samples with a white noise generator.

String Resonance

Sympathetic string resonance in an acoustic piano is the phenomenon of undamped piano strings resonating as a result of sound from other notes/keys. This can be observed if one plays a C, continues holding down the key after the sound has decayed, and then forcibly presses and quickly releases another C key. The undamped strings of the held-down C key will audibly ring, providing a highly tuned “echo”, commonly known as sympathetic string resonance.

The String Resonance parameter works in conjunction with the FX preset “600 String Resonance” to emulate the sound of strings resonating in an acoustic piano. When combined, these two components create KSR (Kurzweil String Resonance). Factory programs in the Piano category are set up to use KSR, and they provide a good example of how the two components should be used. When making your own program with KSR, it may be easiest to use an FX Chain from one of these programs, since they already contain controller assignments for KSR. In these Programs and Chains the dry/wet mix of the KSR effect can be controlled with Slider 6, and the effect can be enabled or disabled with assignable switch button 6. When making your own Chain, the FX preset “600 String Resonance” should be used for the first box of the Program's insert Chain.

When a layer has the String Resonance parameter set to On, the FX preset “600 String Resonance” monitors which keys are being held on that layer and uses them to tune the algorithm in the FX preset. Any audio that passes through the FX preset while these keys are held will cause emulated strings to resonate based on this tuning. When using KSR, layers which contain samples of piano notes should have the String Resonance parameter set to On. Layers that do not play samples of piano notes (such as layers for mechanical key release

Program Edit Mode

The KEYMAP Page

noise, pedal noise, string/synth layers etc) should have the String Resonance parameter set to Off. (Layers set to Off will still resonate any other strings that have been emulated.) If more than one layer in a program is set to play piano notes for the exact same velocity and key range, the FX preset will function the best if only one of those layers has the String Resonance parameter set to On.

In an acoustic piano, it is possible to strike and hold a key very lightly so that a note is not played, but the key's strings will still become undamped and will resonate when other keys are played. KSR can simulate this behavior. To do so, select the layer in the program which has the lowest velocity range and which has the String Resonance parameter set to On. On the Layer page, set the Enable parameter to GAttVel, and set the Enable Min parameter to 2. This will allow notes played with a velocity of 1 to tune the algorithm in FX preset "600 String Resonance" without playing a note. (This only works for velocities of 1. Velocities above 1 will not tune the algorithm without playing a note, even if the Enable Min parameter is set to a higher value.)

The LAYER Page

Use the Layer page to set the current layer's keyboard range, velocity range, and other layer specific parameters.

EDIT:Program Layer		Layer:1/20	
Low Key	C#0	Delay Control	OFF
High Key	C 8	Min Delay	0.000s
Low Velocity	ppp	Max Delay	0.000s
High Velocity	fff	Enable	ON
Enable Low	64	Enable High	127
Bend	All	Enable Sense	Normal
Trigger	Pedal Down	Opaque	Off
Sustain Pedal	On	Sostenuto Pedal	On
Freeze Pedal	On		
Ignore Release	Off		
Hold Through Att	Off		
Hold Until Decay	Off		

◀ MORE KEYMAP **LAYER** ARP CC SEQ MORE ▶

Low Key, High Key

Use the Low Key and High Key parameters to set the key range for the current layer. The Low Key and High Key parameters set the lowest and highest active notes for the current layer. The standard MIDI key range is C 1—G 9 (0-127). Middle C is C 4.

Low Velocity, High Velocity

Use the Low Velocity and High Velocity parameters to set the velocity range for the current layer. The Low Velocity and High Velocity parameters set the lowest and highest active velocities for the current layer.

Velocity values are set in 8 standard musical dynamics markings (ppp-fff). The 8 available dynamic levels each account for a range of 14-16 velocities out of velocities 1-127. This allows for velocity switching between up to eight layers.

For finer control of velocities levels or velocity switching between up to 32 layers, follow these steps:

1. Set the Low Velocity to ppp, and High Velocity to fff.
2. Set the Layer page Enable parameter to GAttVel (Global Attack Velocity).
3. Set the Layer page Enable Sense parameter to Normal.
4. Set the layer's velocity range in values 1-127 using the Enable Low and Enable High parameters.

Bend

The Bend parameter determines how Pitch bend control messages will affect the current layer. To apply the same Bend setting to the entire program, set the same value for each layer.

When Bend is set to All, pitch bend is applied to all notes.

When Bend is set to Key and the sustain or sostenuto pedal is held, pitch bend is applied only to the keys that are pressed down (pitch bend is not applied to notes held with the pedals). This is useful for emulating guitar string bending techniques. For example, you can play and release a sustained a note held with the sostenuto pedal (as a guitarist might with an open string), then play pitch bent notes over the sustained note; the note held with sostenuto will not bend. When the pedals are not held all notes will bend (including notes which have a long release envelope, even for keys which are not being pressed down).

When Bend is set to Off, pitch bend is disabled for the current layer.

Trigger

When the Trigger parameter is set to Normal, notes are triggered when a key is pressed down and a MIDI note on message is received by the layer.

When the Trigger parameter is set to Reverse, notes are triggered when a key is released and a MIDI note off message is received by the layer (velocity is determined by the release velocity of the released key).

When the Trigger parameter is set to Pedal Down or Pedal Up, notes are triggered when the sustain pedal is pressed down or released (typically used for triggering piano pedal noise samples). The sustain pedal will trigger MIDI note 60 with a velocity of 64.

Delay Control

The delay parameters allow you to set an adjustable delay time to delay the start of each note triggered in the current layer.

Use the Delay Control parameter to select a physical controller or other control source that will adjust the delay time. The delay time will be adjusted with the range set by the Min Delay and Max Delay parameters.

Minimum Delay, Maximum Delay

The delay parameters allow you to set an adjustable delay time to delay the start of each note triggered in the current layer. Use the Min Delay and Max Delay parameters the range of the delay time in seconds.

If the Delay Control parameter is set to OFF, the Min Delay setting is used. If the Delay Control parameter is set to ON, the Max Delay setting is used.

Enable, Enable Low, Enable High, Enable Sense

Use the Enable parameters to determine when the layer will be active, based on the value of a physical controller or other control source. For details on using the Enable parameters with velocity, see [“Low Velocity, High Velocity” on page 3-45](#).

Use the **Enable** parameter to select a control source that can activate or deactivate the layer. Some local control sources (KeyNum and AttVel, for example) are not valid for the Enable parameter. In these cases, you should use the global equivalent (GKeyNum and GAttVel in this example).

Use the **Enable High** and **Enable Low** parameters to select a control source value range that can activate or deactivate the layer.

When the **Enable Sense** parameter is set to Normal, the layer will become active when the control source is in the range set by Enable High and Enable Low. The layer will be deactivated when it is out of this range.

When the **Enable Sense** parameter is set to Reverse, the layer will become active when the control source is out of the range set by Enable High and Enable Low. The layer will be deactivated when it is in this range.

Opaque

An opaque layer blocks all higher-numbered layers in its key and velocity range, allowing only the opaque layer to play. This is an easy way to change a small range of notes in a program, leaving the original sound playing above and below the new sound. For example:

1. Edit a one-layer program, and create a new layer (Layer 2) with the **NEW LYR** soft button.
2. On the Layer 2 Keymap page, select a keymap with a different instrument sound.
3. On the Layer 2 Layer page, set Low Key C 3 and High Key to D 3.
4. On the Layer 2 Layer page, set the Opaque parameter to **On**.
5. Go back to Layer 1 and duplicate it by pressing the **DUP LYR** soft button. The duplicate layer becomes Layer 3. You now have a three-layer program.
6. Delete Layer 1 (the original layer). Layer 2 (the layer you created with NEW LYR) becomes Layer 1, and Layer 3 (the layer you create with DUP LYR) becomes Layer 2. Now Layer 1 blocks out Layer 2 at the notes C 3–D 3.

Sustain Pedal

The Sustain Pedal parameter determines how the layer will respond sustain messages (MIDI CC 64), typically sent from the sustain pedal (the SW1 SUSTAIN jack).

When the Sustain Pedal parameter is set to **Off**, notes will not respond to sustain messages.

When the Sustain Pedal parameter is set to **On**, any note that is played or is already playing when the pedal is pressed and held will be sustained for as long as the pedal is held. This setting is useful for piano sounds that do not respond to half damper pedal techniques.

When the Sustain Pedal parameter is set to **On2**, any note that is played while the pedal is pressed and held will be sustained for as long as the pedal is held, unless the notes have been released. Notes that are already playing the release segment of their amplitude envelope will not be sustained. This is useful for most instrument sounds other than piano, where notes may have a long amplitude envelope release time. For example, for a string or synth sound that may have a long release time, use On2 to prevent previously released notes from being sustained.

When the Sustain Pedal parameter is set to **On3**, any note that is played or is already playing when the pedal is pressed and held will be sustained for as long as the pedal is held. The On3 setting also enables the use of half damper pedal techniques when using a compatible continuous switch pedal (such as the Kurzweil KP-1H). On3 emulates the behavior of an acoustic piano's sustain pedal by increasing the release portion of the current layer's amplitude envelope as the pedal is pressed down, before becoming fully sustained. This allows you to use a sustain pedal to control note release length and sustain. This setting is useful for piano sounds that respond to half damper pedal techniques.

Sostenuto Pedal

The Sostenuto Pedal parameter determines how the layer will respond sostenuto messages (MIDI CC 66), typically sent from the sostenuto pedal (the SW2 jack).

When the Sostenuto Pedal parameter is set to **Off**, notes will not respond to sostenuto messages.

When the Sostenuto Pedal parameter is set to **On**, any keys that are being held when the pedal is pressed and held will sustain for as long as the pedal is held. Notes played after the pedal is already down do not get sustained.

Freeze Pedal

The Freeze Pedal parameter determines how the layer will respond freeze messages (MIDI CC 69).

When the Freeze Pedal parameter is set to **Off**, notes will not respond to freeze messages.

When the Freeze Pedal parameter is set to **On**, any note that is played or is already playing when MIDI CC 69 is received with a value of 64-127 will sustain without decay, until MIDI CC 69 is received with a value of 0-63. If a note is already decaying, it will freeze at that level.

Ignore Release

When the Ignore Release parameter is set to Off, the layer responds normally to Note Off messages.

When the Ignore Release parameter is set to On, the layer will ignore all Note Off messages that it receives. This should be used only with sounds that decay to silence when a note is held, otherwise the sounds will sustain forever (press PANIC to stop sustained notes).

Hold Through Attack (Hold Through Att)

When the Hold Through Att parameter is set to Off, a note will enter the release segment of the amplitude envelope as soon as a key is released.

When the Hold Through Att parameter is set to On, a note will always play the entire first attack segment of the amplitude envelope, even if a key is released. This is useful for layers which have a long amplitude envelope attack segment, or an attack that's delayed with the layer delay parameters. Setting this parameter to On will cause notes to reach full amplitude even if each key is only held for a short time.

Hold Until Decay

When the Hold Until Decay parameter is set to Off, a note will enter the release segment of the amplitude envelope as soon as a key is released.

When the Hold Until Decay parameter is set to On, a note will always play the entire first three attack segments of the amplitude envelope, even if a key is released. This is useful for layers which have long amplitude envelope attack segments, or an attack that's delayed with the layer delay parameters. Setting this parameter to On will cause notes to play all attack segments of the amplitude envelope, even if each key is only held for a short time.

The Wiring Algorithm (ALG) Page

The PC4's algorithms are the core of VAST programs (Variable Architecture Synthesis Technology). Use the Wiring Alg page to select an algorithm and route DSP (digital signal processing) functions for the current layer. Several DSP functions are available including filters, equalizers, oscillators, amplifiers, mixers, panners, distortion, shapers, and aliases. DSP functions contain adjustable parameters which can be set to a single setting, or controlled by a physical controller or other control source (such as an LFO or envelope).



Algorithm

Use the Algorithm parameter to select an algorithm by ID number. A diagram of the selected algorithm is shown in the center of the page, showing the selected DSP functions and audio signal flow wiring. In the diagram, the audio signal flows through each DSP block from left to right.

Depending on the algorithm, the signal may split into two wires, enabling part of the signal to bypass certain portions of the algorithm. Split wires may rejoin within the algorithm, or they may pass all the way through as split signals.

Each of the factory algorithms represents a preset signal path. See the [The Wiring Alg Editor \(Dynamic VAST\) on page 3-52](#) for details on making user algorithms with custom signal paths.



Caution: Changing a layer's algorithm can affect the layer's sound drastically. It's a good idea to turn down the volume of your PC4 or your sound system before changing algorithms.

Alt Input

When the Alt Input parameter is set to None, the Keymap of the current layer is used as the algorithm input signal.

When the Alt Input parameter is set to 1-32, the output of the selected layer number is used as the algorithm input signal. This feature is known as cascade mode, because the output of each layer can cascade into the input of another layer. This allows a single layer to be processed by up to 32 layers of algorithms.



Note: When Alt Input is set to a layer which uses a stereo keymap, or a layer which uses a wiring algorithm that has separate left and right outputs (Output Mode set to Sep. L/R), only the left channel of the stereo signal is used by the receiving layer (summed to mono).

DSP Functions

Several DSP functions are available including filters, equalizers, oscillators, amplifiers, mixers, panners, distortions, shapers, and aliasers. DSP functions contain adjustable parameters which can be set to a single setting, or controlled by a physical controller or other control source (such as an LFO or envelope).

The DSP functions are represented in the algorithm diagram as rectangular blocks.

Each DSP function has one or more parameters to which you can adjust and apply a variety of modulation sources on the DSP CTL and DSP MOD pages. For details see [“The DSP Control \(DSP CTL\) Page” on page 3-54](#) and [“The DSP Modulation \(DSP MOD\) Page” on page 3-56](#).

PITCH and AMP

Each algorithm contains a PITCH block at the input, and AMP block at the output. When the Alt Input parameter is set to None, the Keymap of the current layer is used as the algorithm input signal. In this case, the left-most PITCH block controls the pitch of the samples in the keymap. The right-most AMP block always controls the final amplitude of the signal.

Selectable DSP Functions

Between the PITCH and AMP blocks, up to 4 DSP functions can be selected.

DSP functions vary in size depending on their complexity and number of parameters. The smallest DSP function is a single DSP block, it can have a single adjustable parameter, and 4 of these DSP blocks can be fit in a single layer. The largest DSP function is a 4 block DSP function, it can have up to 4 adjustable parameters, and 1 of these DSP blocks can be fit in a single layer.

Program Edit Mode

The Wiring Algorithm (ALG) Page

To select a DSP function, use the navigation buttons to select a block, then use the Alpha Wheel or PREVIOUS and NEXT buttons to select one of the DSP functions available for the selected block. Based on the selected block's size and wiring, different DSP functions will be available.

Some DSP functions are available in different block sizes, with larger block sizes generally offering more parameters or higher sound quality. For example, the one block LOPASS function is a low pass filter with a single parameter, LP Frq, while the two block 2POLE LOWPASS function is a low pass filter with two parameters, LP Freq and LP Res. Similarly, the one block SQUARE oscillator has a single parameter, Sqr Pch, while the two block SQUARE oscillator also has a single parameter, Sqr Pch, but provides higher sound quality through anti-aliasing.

In order to select a DSP function, you must first select an algorithm with the appropriate block size and wiring. Depending on the size and wiring of the selected block, different DSP functions may be available.

A diagram of the selected algorithm is shown in the center of the page, showing the selected DSP functions and audio signal flow wiring. In the diagram, the audio signal flows through each DSP block from left to right.

Depending on the algorithm, the signal may split into two wires, enabling part of the signal to bypass certain portions of the algorithm. Split wires may rejoin within the algorithm, or they may pass all the way through as split signals.

The Wiring Alg Editor (Dynamic VAST)

The Wiring Alg Editor allows you to access Dynamic VAST by editing the wiring of an algorithm. With Dynamic VAST, literally thousands of wiring schemes are possible.

To enter the Wiring Alg Editor, select the Algorithm parameter on the Wiring Alg page, select an algorithm, and press the EDIT button.



In the Wiring Alg Editor, each function block has three editable parameters: number of inputs, number of outputs, and block size. (The Output Mode parameter applies to the entire algorithm.)

To select a block for editing, move the cursor down the display until no parameter field is highlighted; then, using the < and > buttons, highlight a block to edit. Press the ^ button to move the cursor back into the parameter fields, and then select a parameter to edit.

To edit the wiring signal path, select either an input of a block or an output of the entire algorithm. By scrolling with Alpha Wheel or the Previous- and Next+ buttons, you can see every possible wiring configuration for that selected signal path.

Inputs

Use the Inputs parameter to select the number of inputs for the currently selected DSP block.

Num Blocks

Use the Num Blocks parameter to select the number of blocks for the currently selected DSP block.

Outputs

Use the Outputs parameter to select the number of outputs for the currently selected DSP block.

Output Mode

The Output Mode parameter determines the number of outputs from the algorithm. With Output Mode set to Normal, the algorithm has one output. With Output Mode set to Sep. L/R, the algorithm has two outputs, each of which is sent to a separate stereo channel.

The DSP Control (DSP CTL) Page

Use the DSP Control page to make coarse or fine adjustments to parameters of each DSP block in the algorithm, and to adjust parameters for hard-wired modulation sources.

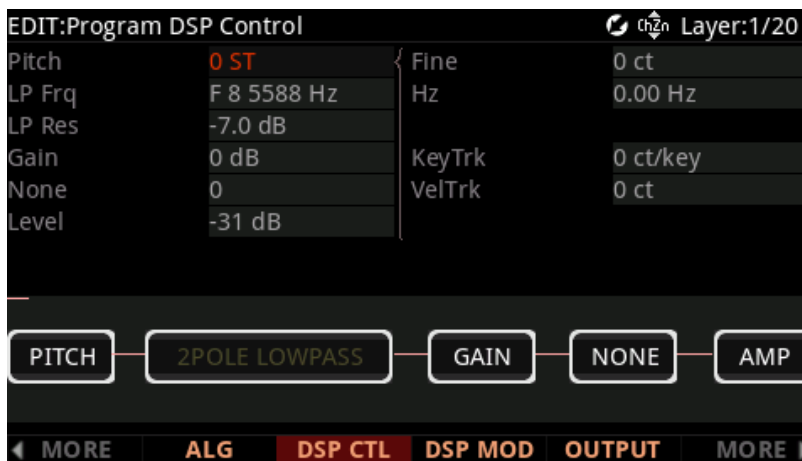

Function-parameter

The left-hand column of the DSP CTL page shows each function-parameter of the current layer's algorithm. You can coarsely adjust the selected function-parameter in these left-hand fields.

The function-parameters are listed along the left-hand side of the DSP CTL page and the DSP MOD page. The label of each function-parameter depends on its function in the current program's algorithm. For example, the Pitch function's function-parameter is labeled Pitch; and the two-block Lopass function's function-parameters are labeled LP Frq and LP Res.

Use each function-parameter to make coarse adjustments to each DSP function. Depending on the parameter, values may be set in semitones (ST), cents (ct), decibels (dB) or Hertz (hz). These adjustments are also combined with any modulation applied to each DSP function on the DSP CTL and DSP MOD pages.

Subpage Parameters

The right-hand side of the DSP CTL page shows a subpage with fine adjust and hard-wired modulation parameters for the selected function-parameter. To access the parameters on the subpage, highlight the function-parameter you wish to edit, and then press the > button to move the cursor into the subpage. The label of a function-parameter depends on its corresponding function-block in the current layer's algorithm.

Fine

Use the Fine parameter to make fine adjustments to the selected function-parameter. Not all function-parameters have a Fine parameter.

The default Pitch function-parameter has two fine adjust parameters. The Fine parameter changes the pitch in cents (100ths of a semitone). The Hz parameter changes pitch according to its frequency in Hertz (cycles per second).

Key Tracking

Use the KeyTrk parameter to modulate the selected function-parameter based on the MIDI note number of each note played.

Positive KeyTrk values will progressively increase modulation depth for each note played above middle C, and progressively decrease modulation depth for notes played below middle C. For example, with a positive KeyTrk value, playing middle C causes no change in modulation depth, playing each key further above middle C increases the modulation depth by the KeyTrk amount, and playing each key further below middle C decreases the modulation depth by the KeyTrk amount.

Negative KeyTrk values will progressively decrease modulation depth for each note played above middle C, and progressively increase modulation depth for notes played below middle C. For example, with a negative KeyTrk value, playing middle C causes no change in modulation depth, playing each key further above middle C decreases the modulation depth by the KeyTrk amount, and playing each key further below middle C increases the modulation depth by the KeyTrk amount.

For the default Pitch function-parameter, the value set for the KeyTrk parameter on the DSP CTL page is added to the value set for the key tracking parameter on the KEYMAP page.

Velocity Tracking

Use the VelTrk parameter to modulate the selected function-parameter based on the MIDI velocity of each note played.

Positive VelTrk values will progressively increase modulation depth for higher velocities. For example, with a positive VelTrk value, playing a velocity of 0 causes no change in modulation depth, playing each velocity further above 0 increases the modulation depth by the VelTrk amount.

Program Edit Mode

The DSP Modulation (DSP MOD) Page

Negative VelTrk values will progressively decrease modulation depth for higher velocities. For example, with a negative VelTrk value, playing a velocity of 0 causes no change in modulation depth, playing each velocity further above 0 decreases the modulation depth by the VelTrk amount.

The DSP Modulation (DSP MOD) Page

Use the DSP Modulation page to make coarse adjustments to parameters of each DSP block in the algorithm, and to adjust parameters for selectable modulation sources.

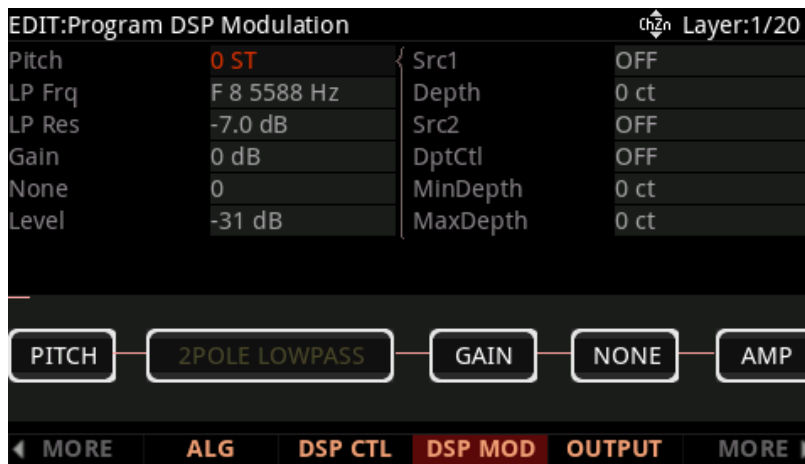

Function-parameter

The left-hand column of the DSP MOD page shows each function-parameter of the current layer's algorithm. You can coarsely adjust the selected function-parameter in these left-hand fields.

The function-parameters are listed along the left-hand side of the DSP MOD page and the DSP CTL page. The label of each function-parameter depends on its function in the current program's algorithm. For example, the Pitch function's function-parameter is labeled Pitch; and the two-block Lopass function's function-parameters are labeled LP Frq and LP Res.

Use each function-parameter to make coarse adjustments to each DSP function. Depending on the parameter, values may be set in semitones (ST), cents (ct), decibels (dB) or Hertz (hz). These adjustments are also combined with any modulation applied to each DSP function on the DSP MOD and DSP CTL pages.

Subpage Parameters

The right-hand side of the DSP MOD page shows a subpage with selectable modulation sources for the selected function-parameter. To access the parameters on the subpage, highlight the function-parameter you wish to edit, and then press the > button to move the cursor into the subpage. The label of a function-parameter depends on its corresponding function-block in the current layer's algorithm.

Source 1

Use the Source 1 parameter to modulate the selected function-parameter with a physical controller or other control source.

Depth

Use the Depth parameter to set the maximum modulation depth of Source 1.

When a Source 1 control source is at its minimum value, Source 1 will have no effect on the function-parameter.

When a Source 1 control source is at its maximum value, Source 1 will apply the amount of modulation set by the Depth parameter.

Source 1 control source values between the minimum and maximum will scale the amount of modulation between no effect and the amount set by the Depth parameter

Source 2

Use the Source 2 parameter to modulate the selected function-parameter with a physical controller or other control source.

DptCtl (Depth Control)

Use the DptCtl parameter to modulate the Source 2 modulation depth with a physical controller or other control source.

When a DptCtl control source is at its minimum value, the Source 2 modulation depth will be set to the value of the MinDepth parameter.

When a DptCtl control source is at its maximum value, the Source 2 modulation depth will be set to the value of the MaxDepth parameter.

DptCtl control source values between the minimum and maximum will scale the Source 2 modulation depth between the values of the MinDepth and MaxDepth parameters.

MinDepth

Use the MinDepth parameter to set the minimum modulation depth of Source 2.

When a DptCtl control source is at its minimum value, Source 2 will apply the amount of modulation set by the MinDepth parameter.

Program Edit Mode

The OUTPUT Page

MaxDepth

Use the MaxDepth parameter to set the maximum modulation depth of Source 2.

When a DptCtl control source is at its maximum value, Source 2 will apply the amount of modulation set by the MaxDepth parameter.

The OUTPUT Page

Use the Output page to adjust the left/right panning position and other panning settings for each layer. The Output page also contains parameters for remapping the notes of drum programs.

To control panning for all layers at once, use the Out Pan parameter on the Program Edit Common page.

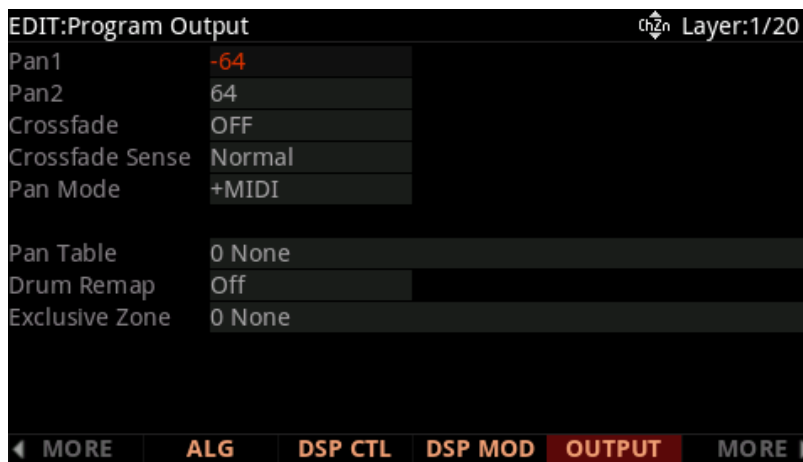

Pan and Pan2

Use the Pan parameter to adjust the panning of the current layer's *pre-FX* signal. Negative values pan the signal to the left channel, positive values pan to the right, and a value of zero pans to the center.

When the Keymap page has the Stereo parameter set to On, the Pan2 parameter appears on the Output page. Use the Pan parameter to adjust the panning of the current layer's *pre-FX* signal for the left keymap (Keymap 1), and use the Pan2 parameter to adjust the panning of the current layer's *pre-FX* signal for the right keymap (Keymap 2).

Crossfade and Crossfade Sense

The Crossfade parameter lets you select a control source to fade the current layer's amplitude from zero to maximum. When CrossFadeSense is **Norm**, the layer is at full amplitude when the Crossfade control is at minimum. With CrossFadeSense set to **Rvrs**, the layer is at zero amplitude when the Crossfade control is at minimum.

To crossfade two layers in the same program, assign the same control source for the CrossFade parameters in both layers, then set one CrossFadeSense parameter **Norm**, and one to **Rvrs**.

These parameters are similar to the Source 1 and Depth parameters for the Amp function on the DSP CTL and DSP MOD pages, but the attenuation curve for the Crossfade parameter is optimized specifically for crossfades.

Pan Mode

When Pan Mode is set to **Fixed**, the pan position remains as defined with the Pan parameter, ignoring MIDI pan messages.

When Pan Mode is set to **+MIDI**, MIDI pan messages (MIDI CC 10) will shift the sound to the left or right of the Pan parameter setting. Message values below 64 shift it left, while those above 64 shift it right.

When Pan Mode is set to **Auto** each note is panned based on its MIDI note number, using the position set by the Pan and Pan2 parameters as the center. Middle C (MIDI note number 60) is equivalent to the position set by the Pan and Pan2 parameters. Lower notes shift increasingly left, while higher notes shift increasingly right. MIDI pan messages (MIDI CC 10) will also affect the pan position.

When Pan Mode is set to **Reverse**, panning behaves the same as the Auto setting, except that lower notes shift increasingly right, while higher notes shift increasingly left.

Out Pan, Out Pan Mode, and Out Gain

When the LYR FX page has the Layer FX Mode parameter set to Layer-Specific FX, the Out Pan, Out Pan Mode, and Out Gain parameters appear on the Output page.

Use the Out Pan parameter to pan the *post* layer FX signal of the current layer; negative values pan the audio signal to the left channel, positive values to the right, and a value of zero pans to the center.

When Out Pan Mode is set to **Fixed**, the pan position remains as defined with the Out Pan parameter, ignoring MIDI pan messages.

Program Edit Mode

The OUTPUT Page

When Out Pan Mode is set to **+MIDI**, MIDI pan messages (MIDI 10) will shift the sound to the left or right of the Pan parameter setting. Message values below 64 shift it left, while those above 64 shift it right.

Use the Out Gain parameter to adjust the gain of the *post* layer FX signal of the current layer.

Pan Table

The Pan Table parameter allows you to select preset per-key panning tables, so that the note that each key produces is uniquely panned. These tables are particularly useful for producing the stereo image of a drum set when creating percussion programs, or for producing the stereo image of a piano when creating piano programs.

Drum Remap

The Drum Remap parameter defines how drum programs are mapped, so that drum sounds can be properly remapped when using the General MIDI (GM) drum map.

The Kurz1 map designates that the current drum program was originally a PC2 program, and that it uses the PC2 drum map.

The Kurz2 map designates that the current drum kit uses a PC4 drum map (all factory drum programs use this map). The Kurz2 map is similar to that of the PC2, except tom-tom sounds have been moved into octave C3-C4, so they are more easily playable with the main kick and snare drum sounds in that octave.

When editing a drum program, make sure to follow the layout of the drum map being used if you want to be able to properly remap the kit to the GM drum map. Programs that have the Drum Remap parameter set to Off will not be viewed by the PC4 as drum programs and will not be affected when remapping to the GM drum map.

To remap drum to the GM drum map, set the Global Mode Drum Remap parameter to GM. For details see [Drum Remap on page 9-14](#).

Exclusive Zone

The Exclusive Zone parameter applies principally to drum programs. When using a drum program, you may want the closed hi-hat sounds to “cut off” open hi-hat sounds. Since you can remap the keymaps of drum programs, this parameter remaps “cut off keys” accordingly.

The Amplitude Envelope (AMP ENV) Page

Use the Amp Envelope page to adjust the amplitude envelope for each layer. The amplitude envelope controls the volume contour of each note played, determining how long it takes for each note to fade in when a key is pressed, and how long it takes for each note to fade to silence when a key is released.

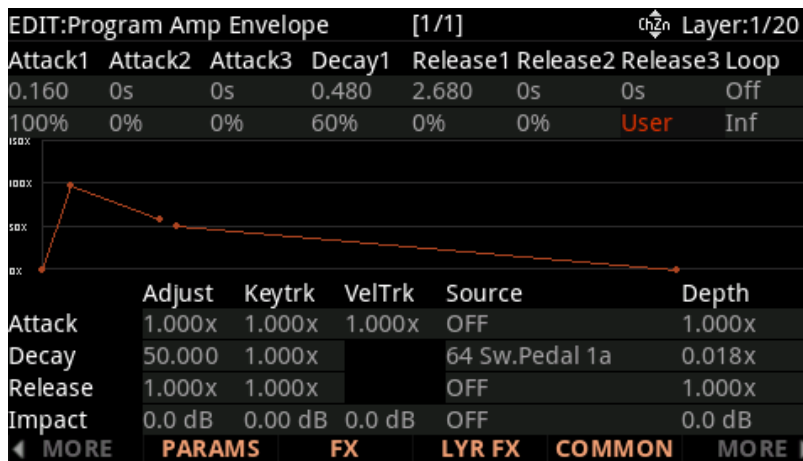

Mode

When the Mode parameter is set to Natural, many of the amplitude envelope parameters are hidden, and a natural envelope is used.

Many factory ROM samples include a natural envelope, which is custom designed for each sample by Kurzweil engineers. A natural envelope contains more detail than a user envelope, and allow samples of acoustic instruments to sound more realistic.

When the Mode parameter is set to User, several amplitude envelope parameters appear. The User setting allows you to adjust several parameters for amplitude envelope attack, decay and release.

Attack1, Attack2, Attack3

When the Mode parameter is set to User, the Attack parameters appear.

The amplitude envelope includes 3 attack segments. Each segment has a field for time (how long it takes to play the segment), and a field for level (a percentage of the maximum possible level for the current layer). Level for the Attack segments can be set from 0 to 100%.

When a note is played, the volume goes from silence to the volume level set by Attack1. Use the two fields below the Attack1 parameter to set a time for Attack1 in seconds, and a volume level in percent.

Program Edit Mode

The Amplitude Envelope (AMP ENV) Page

After the Attack1 segment is played, the Attack2 segment is played. The volume goes from the volume level set by Attack1, to the volume level set by Attack2. Use the two fields below the Attack2 parameter to set a time for Attack2 in seconds, and a volume level in percent.

After the Attack2 segment is played, the Attack3 segment is played. The volume goes from the volume level set by Attack2, to the volume level set by Attack3. Use the two fields below the Attack3 parameter to set a time for Attack3 in seconds, and a volume level in percent.

Decay1

When the Mode parameter is set to User, the Decay1 parameter appears.

After the 3 attack segments are played, the volume goes from the volume level set by Attack3, to the volume level set by Decay1. Use the two fields below the Decay1 parameter to set a time for Decay1 in seconds, and a volume level in percent. To hear a note's decay segment, the note must remain held until after the attack section is completed, otherwise the release segment will be heard.

The Decay1 level sets the sustain level of the amplitude envelope. When a note is played and held, it will sustain at this level. This is analogous to the S (sustain level) of a classic analog ADSR envelope. To create a sustaining amplitude envelope, simply set the Decay1 level to a nonzero value. Level for Decay1 can be set from 0 to 100%.

Release1, Release2, Release3

When the Mode parameter is set to User, the Release parameters appear.

The amplitude envelope includes 3 release segments. Release segments 1 and 2 each have a field for time (how long it takes to play the segment), and a field for level (a percentage of the maximum possible level for the current layer). Release segment 3 only has a field for time. Level for Release segments 1 and 2 can be set from 0 to 150%.

When a note is played, the volume goes from the Decay1 level to the volume level set by Release1. Use the two fields below the Release1 parameter to set a time for Release1 in seconds, and a volume level in percent.

After the Release1 segment is played, the Release2 segment is played. The volume goes from the volume level set by Release1, to the volume level set by Release2. Use the two fields below the Release2 parameter to set a time for Release2 in seconds, and a volume level in percent.

After the Release2 segment is played, the Release3 segment is played. The volume goes from the volume level set by Release2, to silence. Use the time field below the Release3 parameter to set a time for Release3 in seconds.

Loop

When the Mode parameter is set to User, the Loop parameters appear.

The top Loop field determines the Loop type.

A value of Off disables looping for the current layer's amplitude envelope.

Values of seg1F, seg2F, and seg3F are forward loops. In each case, the amplitude envelope plays through the attack and decay sections, then loops back to the beginning of the first, second, or third attack segments, respectively.

Values of seg1B, seg2B, and seg3B, are bidirectional loops. The amplitude envelope plays through the attack and decay sections, then reverses and plays backward to the beginning of the first, second, or third attack segment, respectively. When it reaches the beginning of the assigned attack segment, it reverses again, playing forward to the end of the decay section, and so on.

When the top Loop field is set to a value other than Off, the bottom Loop field determines the number of times that the amplitude envelope will Loop.

A value of Inf makes the amplitude envelope loop until a note is released. A value of 1 through 31 determines how many times the loop will repeat after the amplitude envelope has played through once. Each note will stop looping and play its release segment when the note is released.

Envelope Control

The parameters on the bottom half of the AMP ENV page give you realtime control over the rates of each section of the amplitude envelope for both natural and user envelopes, as well as control over the Impact parameter.

The values for the various envelope control parameters are cumulative. For example, if you set attack to be controlled by KeyTrk and VelTrk, the resulting change on Attack would be affected by the combination of the values produced by KeyTrk and VelTrk.

The values of each of these parameters multiply the *rates* of the envelope sections they control. Values greater than 1.000x make the envelope sections run faster (they increase the rate), while values less than 1.000x make the envelope sections run *slower*. Say for example that on the current layer you had set the Decay section's time at 2.00 seconds, and its level at 0%. This sets the layer's amplitude to fade to silence two seconds after the completion of the last attack segment. The decay time is two seconds; the decay rate is 50% per second. Now if you set the Decay Adjust parameter to a value of 2.000x, you've increased the decay rate by a factor of two, making it twice as fast. The rate increases to 100% per second, and the decay time is now one second instead of two.



Note: Since 0 multiplied by any number equals 0, the envelope control parameters on this page will have no effect on any AMP ENV sections set to 0 seconds. A way around this is to change any AMP ENV sections set to 0 to 0.02 seconds.

There is an exception for the first attack segment: If the first attack segment is set to 0 seconds and an envelope control parameter is applied, an offset of .002 seconds will be applied internally when any of those envelope control values does not equal 0. This allows attack time to be controlled even when attack is set to 0 seconds.

Adjust

Use the Adjust parameter to offset the envelope rate of each amplitude section.

When a control source is selected for the Source field, use the Adjust and Depth fields to set the range of envelope control. When the control source selected for the Source field is at its minimum value, the Adjust amount is applied to the rate of the selected amplitude section. When the control source selected for the Source field is at any value above its minimum value, the Adjust amount is applied to the rate of the selected amplitude section and added to the control source's current value multiplied by the Depth parameter.

Keytrk

Use the Keytrk parameter to control the envelope rate of each amplitude section based on the MIDI note number of each key played. Applying Keytrk to the Release segment is useful for emulating acoustic string and percussion instruments, in which lower notes often have longer release times, and higher notes often have shorter release times.

Keytrk uses the MIDI note number of each key as a control source. When Keytrk is greater than 1.000x, notes above C 4 will make the envelope section run faster, while notes below C 4 will make it run slower. When Keytrk is less than 1.000x, notes above C 4 will make the envelope section run slower, and notes below C 4 will make it run faster.

VelTrk

Use the VelTrk parameter to control the envelope rate of the attack amplitude sections based on the MIDI velocity of each key played. Applying VelTrk is useful for emulating bowed acoustic string instruments, in which louder notes often have faster attack times, and softer notes often have longer attack times.

When the value of this parameter is greater than 1.000x, attack velocities greater than 64 make the attack section run faster, and attack velocities below 64 make it run slower.

VelTrk is not available for the decay and release segments, however you can achieve a similar control by selecting attack velocity (GAttVel) as a control source for the Decay or Release Source parameters.

Source

Use the Source parameter to assign a control source to control the envelope rate of each amplitude section. Use the Adjust and Depth fields to set the range of envelope control.

Depth

Use the Depth parameter to set the range of envelope control for the controller set in the Source field.

When a control source is selected for the Source field, use the Adjust and Depth fields to set the range of envelope control. When the control source selected for the Source field is at its minimum value, the Adjust amount is applied to the rate of the selected amplitude section. When the control source selected for the Source field is at any value above its minimum value, the Adjust amount is applied to the rate of the selected amplitude section and added to the control source's current value multiplied by the Depth parameter.

Impact

Impact can boost or cut note volume by up to 24 dB during the first 20 milliseconds of the attack of an envelope. This feature is an easy way to get more “thump” from your bass and drum sounds.

The Envelope 2 (ENV2) and Envelope 3 (ENV3) Pages

Use the Envelope 2 and Envelope 3 pages to adjust the envelopes 2 and 3 for each layer. Unlike the amplitude envelope, which always controls the volume contour of each note played, envelope 2 and 3 are control sources which have no affect until they are assigned to modulate a parameter in the layer. For example, envelope 2 is commonly used to modulate filter frequency, but can be assigned to modulate any parameter in the layer.

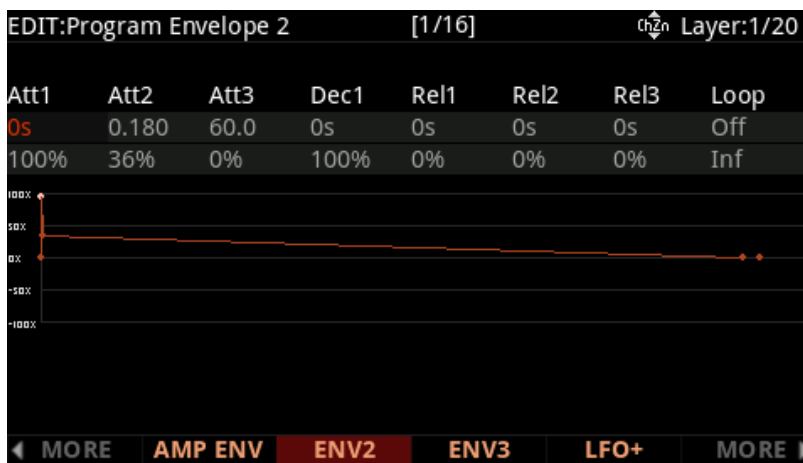

The envelope 2 and 3 parameters are the same as the amplitude envelope parameters, with a few exceptions:

ENV2 and ENV3 are bipolar, envelope values can be set from -100% to 100%.

The ENV2 and ENV3 attack segments are linear, meaning the attack segments increase at the same rate from start to finish. (AMP ENV uses an exponential attack, meaning the amplitude rises much faster at the end of the attack segment than it does at the beginning.)

The ENV2 and ENV3 Rel3 segment can be set to values from -100% to 100%, unlike the AMP ENV Release3 segment which always returns to 0%.

ENV2 and ENV3 do not have envelope control parameters.

See [“The Amplitude Envelope \(AMP ENV\) Page” on page 3-61](#) for details on each envelope parameter.

The LFO+ Page

Use the LFO+ page to adjust LFOs, ASRs, and FUNs for each layer.

EDIT:Program LFO/ASR/FUN						chn Layer:1/20
	MnRate	MxRate	RateCt	Shape	Phase	
LFO1	0.00H	0.00H	OFF	None	0 deg	
GLFO2	0.00H	5.00H	ON	Sine	0 deg	
	Trigger		Mode	Delay	Attack	Release
ASR1	OFF		Norm	0s	0s	0s
GASR2	OFF		Norm	0s	0s	0s
	Input a		Input b		Function	
FUN1	OFF		OFF		None	
GFUN2	OFF		OFF		None	
FUN3	OFF		OFF		None	
GFUN4	OFF		OFF		None	
◀ MORE AMP ENV ENV2 ENV3 LFO+ MORE ▶						

LFO Parameters

LFOs are low-frequency oscillators, periodic (repeating) control sources. LFOs are used to repeatedly modulate a parameter based on the shape and frequency of an audio waveform. You can control the LFO rate in real time (which defines how frequently the LFO repeats) in Hz, or in note values in order to sync with the program tempo. You can also select from many wave shapes, which defines the waveform of the modulation signal.

LFOs are commonly used for creating effects like vibrato (cyclic variation in pitch) and tremolo (cyclic variation in amplitude). Each LFO must be assigned to control some parameter before you'll hear the effect.

LFO1 is always local, meaning that it's triggered with each Note On event, and runs independently for each note in the layer.

LFO2 is local by default, but can be made global by setting the Common page Globals parameter to **On**. Global LFOs uniformly affect every note in each layer, and start running as soon as the program containing them is selected, even if you don't play any notes.

Minimum Rate

The MnRate parameter sets the slowest rate at which the LFO runs. Each LFO runs at the minimum rate when its RateCt parameter is set to OFF, or when the control source assigned to RateCt is at its minimum value.

The values 1/4 nt, 1/8 nt, 1/8 tr, and 1/16 nt will sync the Minimum Rate with the program tempo (see [“Tempo” on page 3-24](#) for details). When a note value is selected, the LFO rate is fixed, and the MaxRate and RateCt field are hidden.

Maximum Rate

The MxRate parameter sets the fastest rate at which the LFO runs. Each LFO runs at the maximum rate when its RateCt parameter is set to ON, or when the control source assigned to RateCt is at its maximum value.

Rate Control

Use the RateCt parameter to assign a control source to modulate the LFO rate between the minimum and maximum rates.

Shape

Use the Shape parameter to select an LFO waveform shape. The LFO wave shape determines the nature of its effect on the signal its modulating. For example, the Sine waveforms move smoothly between values, while the Square waveforms jump abruptly between values.

Phase

Use the Phase parameter to determine the LFO's start point in the waveform.

When an LFO is local, the phase parameter determines the start point in the LFO waveform for each note. For example, you could make sure every vibrato started below the pitch you played instead of at the pitch you played. The LFO's phase also affects global LFOs, although it's often indistinguishable, since global LFOs start running as soon as the program containing them is selected, even if you don't play any notes.

One complete cycle of the LFO is 360 degrees, and each 90-degree increment in the phase represents a quarter-cycle of the LFO. For example, 0 degrees phase will play the LFO from the start of the waveform, 90 degrees phase will play the LFO from a quarter way through the waveform, 180 degrees phase will play the LFO from half way through the waveform, and 270 degrees phase will play the LFO from three quarters through the waveform.

ASR Parameters

ASRs are unipolar envelopes with three sections: attack, sustain, and release. The PC4's ASRs can be triggered in a variety of ways, and can also be looped for use as periodic (repeating) control sources, similar to LFOs.

ASR1 is always local, meaning that it's triggered with each Note On event, and runs independently for each note in the layer.

ASR2 is local by default, but can be made global by setting the Common page Globals parameter to **On**. Global ASRs uniformly affect every note in each layer, and start running as soon as the program containing them is selected, even if you don't play any notes.

Trigger

The Trigger parameter defines the control source that triggers the attack segment of each ASR. When a switch control source is selected, the ASR is triggered when the control value changes from off to on. When a continuous control source is selected, the ASR is triggered when the control value changes from below its middle point to above its middle point.

When the Trigger parameter is set to ON, a local ASR will be triggered for each note played in the layer, and a global ASR will be triggered immediately when you select a program is selected.

Mode

The Mode parameter determines what the ASR does after playing the attack section.

When the Mode parameter is set to Normal, the ASR will play the attack section, then will immediately play the release section. The sustain section of the ASR will not be played.

When the Mode parameter is set to Repeat, the ASR will play the attack section, then will immediately play the release section, then will loop repeatedly through the attack and release sections until the ASR's trigger switches off. The sustain section of the ASR will not be played.

When the Mode parameter is set to Hold, the ASR will play the attack section, then will sustain at the highest value until the ASR's trigger switches off. The ASR then plays its release section. If the ASR's trigger switches off before the attack section is complete, the ASR immediately plays its release section.

Delay

The Delay parameter can be used to set a delay time in order to add a delay before playing the attack section. When the ASR's trigger switches on, the ASR will wait the set amount of time before playing the attack section.

Attack

The Attack parameter sets how long the ASR attack section takes to ramp up from minimum to maximum value.

Release

The Release parameter sets how long the ASR release section takes to ramp down from its current value to its minimum value.

FUN Parameters

FUN is short for function. FUNs are mathematical functions that allow you to flexibly combine and modify modulation signals from multiple control sources.

Each FUN accepts input from two control sources, performs a selectable function on the two input signals, and sends the result as its output, which can be assigned like any other control source.

Input a, Input b

Use the Input a and Input b parameters to select two inputs for each function. Inputs can be control sources (MIDI controllers, LFOs, envelopes, etc) or constant values between -1 and +1.

All control source inputs to FUNs are scaled to a value in the range 0 to +1 (unipolar), or -1 to +1 (bipolar). Most inputs are unipolar, but some inputs (like envelopes and LFOs) may be unipolar or bipolar depending on their settings.

Most MIDI controllers are unipolar, so their 0-127 range gets scaled to 0 to +1. Some MIDI controllers can be bipolar as well. For example, the control source list has 2 choices for Mod Wheel: Mod Wheel (unipolar) and Bi-Mwl (bipolar).

For a unipolar input, a value of OFF equals a constant value of 0, and a value of ON equals a constant value of +1.

For a bipolar input, a value of -ON equals a constant value of -1, and a value of ON equals a constant value of +1.

Function

The Function parameter determines what mathematical function is applied to the two inputs.

The output of FUNs can act as unipolar or bipolar control sources, depending on the values of the inputs and the selected function. When the output of a FUN is used as a Mod control source, the -1 to +1 range of values is scaled based on the Depth setting of the Mod source. See the K2600 Musician's Guide at kurzweil.com for more details and a description of each available FUN.

The Soft Button Functions

Some of the soft buttons in Program Edit Mode perform a function when pressed.

New Layer (NEW LYR)

Press the NEW LYR soft button to create a new VAST layer. A new layer will be created numbered one above the highest layer in the Program. A VAST layer can use samples, oscillators, and various DSP functions.

Duplicate Layer (DUP LYR)

Create a copy of the current layer, duplicating the settings of all its parameters. The copy becomes the current layer, and is the highest-numbered layer in the program.

Import Layer (IMP LYR)

Use the IMP LYR button to go to the Import Layer page, where you can copy a specific layer from another program into the current program. Importing layers is a convenient alternative to creating layers from scratch. For example, if you have a favorite string sound, you can import its layers into the current program, preserving all envelopes and control settings.

On the Import Layer page, use the Source Program field to select a program to copy (use the alpha wheel or the **PROG-** or **PROG+** soft buttons to change the source program number).

The Import Layer page allows you to listen to the selected layer of the source program, along with all other layers in the current program (use the alpha wheel or the **LAYER-** or **LAYER+** soft buttons to change the source layer number). For each layer in the selected source program, you can view the layer number, keymap, key range, velocity range, and layer enable control source. Some source layers may not be heard if the layer “Enable” control source causes the layer to be disabled.

To copy the selected layer from the source program into the current program, press the IMPORT soft button.

Delete Layer (DEL LYR)

Press this button to view the Delete Layer Page. You can select a Layer to delete by using the CHANNEL/LAYER/ZONE/TRACK buttons. Press the DELETE soft button to delete the selected Layer, or press the BACK soft button to cancel.

Program Edit Mode

The Soft Button Functions

COMPARE

Press the COMPARE soft button to temporarily recall an unedited version of the program, allowing you to compare your edited program with the original program.

SOLO LYR

Press the SOLO LYR soft button to temporarily solo the currently selected Layer.

MUTE LYR

Press the MUTE LYR soft button to mute the currently selected Layer.

FX BYPASS

Press the FX BYPASS soft button to temporarily bypass the Insert and Aux FX Chains.

Bypassing the FX is useful for checking the output level of a program with and without its FX Chains. If the output level of a program is the same with and without the FX being bypassed, it will prevent sudden jumps in volume that can occur when switching programs while notes are being held. When a new program is selected while notes from the last program are still being held, the FX Chains from the last program may be “stolen” by the new program if there are not enough FX resources for both programs. You may hear a sudden jump in volume if the output of a program is too quiet or too loud without its FX Chains. To fix this, usually the output gain in the last box of the Insert Chain should be adjusted until the program volume is the same with and without bypassing the FX. Afterwards, you may need to adjust the Common Page OutGain of the program to match its level with other programs.

NEW FM

Press the NEW FM soft button to create a new FM layer. A new layer will be created numbered one above the highest layer in the Program. An FM layer contains a set of oscillators designed to emulate classic 6 operator FM synthesizers.

NEW PMTR

When assigning a physical controller or CC number to a VAST source field, a Parameter is automatically added to the Parameters Page (unless the physical controller/MIDI CC is already being used by an existing Parameter on the Parameters Page). In other cases it may be desirable to manually create a new Parameter. Press the NEW PMTR soft button to create

a new Parameter. At the prompt, choose a Destination and then name the Parameter. The Parameter Destination is the default MIDI CC number that the Parameter will send to the Program. The Destination also becomes the default Control for the Parameter. Once the parameter is created, you can change its Control on the Parameters Page.

IGN EDIT

Press the IGN EDIT soft button to ignore edits to parameter values from physical controllers. When the IGN EDIT soft button is pressed and colored red, moving physical controllers which are assigned to parameters on the Parameters page will not change the Value set on the Parameters page. This allows you to edit a program and try different controller settings without losing the values that you had previously set on the Parameters page.

DELETE

Press the DELETE soft button to delete the current Program (factory Programs can not be deleted). Press DELETE, and you will be given a choice to DELETE or CANCEL. Press DELETE again, and an “*Are You Sure?*” message will appear. Press YES to delete the Program, or CANCEL to cancel.

The Mode Button Functions

In Program Edit Mode, the Mode buttons act as shortcuts for some of the soft button functions.

Program Mode Button (Solo Layer)

Press the Program Mode button to temporarily solo the currently selected Layer.

Multi Mode Button (Mute Layer)

Press the Multi Mode button to temporarily mute the currently selected Layer.

Song Mode Button (FX Bypass)

Press the Song Mode button to temporarily bypass the Insert and Aux FX Chains. See the FX BYPASS section above for more details.

Global Mode Button (Compare)

Press the Global Mode button to temporarily recall an unedited version of the program, allowing you to compare your edited program with the original program.

Editing VAST Programs With KVA Oscillators

The PC4 uses KVA oscillators as another way to generate sounds in VAST programs. Unlike keymaps, which play samples stored in ROM, KVA oscillators create DSP-generated waveforms every time they are triggered. The KVA oscillators can create a range of waveforms, from high quality simple waveforms familiar to users of classic analog synths, to complex waveforms which take advantage of the PC4's internal processing power and complex signal routing capabilities. Though the PC4 does have keymaps containing samples of basic synth waveforms, the use of KVA oscillators provides users with better portamento, more modulation options, higher sound quality, and other advantages which will be explained in this section. Learning to use KVA oscillators instead of keymaps (where appropriate) is simple and will increase the versatility of your VAST editing capabilities. VAST programs using layers with KVA oscillators can also be combined with other layers using keymaps.

Basic Use of KVA Oscillators

Minimal Settings for Basic Use of KVA Oscillators:

These are the minimal settings that a KVA layer needs in order to function in the style of a classic analog synth:

1. Program Edit Keymap Page: Set the Keymap parameter to 999 Silence.
2. Program Edit Amp Envelope Page: Set the Envelope mode to User, and adjust the amplitude envelope to your liking (see [The Amplitude Envelope \(AMP ENV\) Page on page 3-61](#)).
3. Program Edit Wiring Alg Page: Pick an Algorithm and set an Oscillator (see [Setting KVA Oscillator Type on page 3-75](#)).

Further basic VAST settings that you will likely want to adjust are:

- Monophonic On/Off (see [The COMMON Page on page 3-17](#))
- Level Velocity Tracking (see [The DSP Control \(DSP CTL\) Page on page 3-54](#))

Read the [Setting KVA Oscillator Type](#) section below to learn about how to set each type of oscillator. After doing this, you can experiment with making KVA programs by following the above settings, and then setting and listening to each type of oscillator. Once you understand how to do this, see [Advanced Use Of KVA Oscillators on page 3-77](#) to learn how to make your KVA patches more expressive through the use of DSP modulation.

Pitch Settings for KVA Oscillators

Each oscillator (except for noise functions) has its own pitch parameters, and is unaffected by pitch settings that would normally affect keymaps (such as those on the Keymap page). On a program layer, the coarse pitch parameter for the oscillator in use can be found on both the DSP CTL and DSP MOD pages, in the parameters list below the standard Pitch parameter

for keymaps. For each oscillator, its coarse pitch parameter is named by an abbreviation of the oscillator name followed by “Pch” For example, the coarse pitch parameter for a saw wave oscillator will be called Saw Pch. On the DSP CTL sub page for any oscillator Pch parameter, you can adjust fine pitch by cents and Hertz, as well as KeyTrk and VelTrk settings for pitch.



Note: Be sure to differentiate between the different pitch parameters, each used either only for keymaps or only for KVA oscillators. The Pitch parameter on the top left of the DSP CTL and DSP MOD pages always appears in VAST programs but only affects the pitch of keymaps. If a KVA oscillator is being used, this Pitch parameter will have no effect on the layer’s pitch, in which case the oscillator Pch parameter described above must be used to control the pitch of the oscillator.

Setting KVA Oscillator Type

There are 25 Different KVA oscillators, see the sections below for details on each type. The tables below list KVA oscillators by type and function block size. Before setting an oscillator, you must choose an algorithm which includes a block that matches the block size for the oscillator that you wish to use. See [The Wiring Algorithm \(ALG\) Page on page 3-50](#) for more on selecting algorithms. Once you have picked an algorithm with the desired block size, highlight the block and use the Alpha Wheel to scroll through the available functions until you find the desired oscillator.

Some oscillators are available in two versions, anti-aliased (free of digital artifacts) and aliased (exhibiting some digital artifacts in the higher octaves). The anti-aliased versions use more DSP resources, but the improvement in sound quality can be quite noticeable. We strongly recommend using the anti-aliased oscillators for most applications.

The SYNC SQUARE oscillator is an 8 block oscillator that requires the use of two layers (4 blocks each) and the Alt Input feature of cascade mode. See below for details on setting up the Sync Square oscillator.



Note: If you put more than one oscillator in an algorithm, you will only hear the output of the last oscillator in the algorithm, unless an algorithm is used to route the earlier oscillator around the last oscillator and into a MIX function block, or if the last oscillator processes its audio input.

Program Edit Mode

Editing VAST Programs With KVA Oscillators

Anti-Aliased Oscillators	
Size	Name/Type
1 Block	LPNOIZ (noise + low pass filter)
2 Blocks	SINE
	SINE+
	SAW
	RES NOISE (noise + low pass filter with resonance)
	SQUARE
3 Blocks	PWM (Pulse Width Modulation)
4 Blocks	SYNC SAW
	SUPER SAW
	TRIPLE SAW
8 Blocks	SYNC SQUARE (master) >>, >>SYNC SQUARE (slave) (4 blocks each)

Aliased Oscillators	
Size	Name/Type
1 Block	SINE
	SAW
	TRI
	SQUARE
	NOISE
	SINE+
	SAW+
	NOISE+
	SW+SHP (Sawtooth + Shaper)
	2 Blocks
PWM (Pulse Width Modulation)	
FM OPERATOR	
FM SAW OPERATOR	
FM TRI OPERATOR	

Setting Up The Sync Square Oscillator

The Sync Square oscillator is actually comprised of two oscillators, a master and a slave, set up to emulate the way sync square oscillators worked on classic analog synthesizers. To create a program using Sync Square, select **Program 2046 Editor Template**. On the Program Edit Keymap Page, set the Keymap parameter to 999 Silence. On the Program Edit Amp Envelope Page, set the Envelope mode to User, and adjust the amplitude envelope to your liking. On the ALG page, select Algorithm 5 at the top of the page. Use the cursor buttons to select the function block and use the alpha wheel to select the “SYNC SQUARE (master) >>” function. Next, press the “<MORE” soft button to change soft button pages until you see “DUP LYR.” Press DUP LYR to duplicate the layer, creating layer 2. In layer 2, on the ALG page, change the function block to “>> SYNC SQUARE (slave)”, and set the Alt Input parameter to “Layer 1.” The final step is to go to Layer 1’s DSP CTL page and turn the Level parameter all the way down to -96dB (this ensures that you will only hear the output of the slave oscillator on layer 2, which is the intended function of Sync Square).

Now the Sync Square oscillator should be working. The “Syncoff” parameter, Sync Offset, is the main parameter for shaping the tone of this sound. Syncoff sets the sync offset between the master and slave square waves in each corresponding oscillator, which changes the shape of the waveform output by the slave oscillator. The Sync Square oscillator is most expressive when the Syncoff parameter is modulated during performance. Use the DSP MOD page to assign an envelope or continuous controller like the Mod Wheel for this parameter to hear the effect (see [The DSP Modulation \(DSP MOD\) Page](#), as well as [The DSP Control \(DSP](#)

[CTL](#) Page for details on setting up modulation and other ways to control parameters, and see [The Envelope 2 \(ENV2\) and Envelope 3 \(ENV3\) Pages](#) for details on using envelopes as modulation sources). See [Advanced Use Of KVA Oscillators](#) below for some similar examples of how to set and control modulation for oscillator specific functions and other parameters.

To add a DSP function to the Sync Square oscillator, you'll need to use cascade mode. For example, to add a filter, duplicate layer 2 to create layer 3. On layer 3, select the ALG page and choose one of the cascade mode algorithms, algorithms 101-131. For this example, let's use alg 105 with the filter "4Pole Mogue LP" selected for the function block. For the Alt Input parameter, select Layer 2. This routes a pre-Level parameter copy of Layer 2's output into Layer 3. Go to layer 2's DSP CTL page and turn its Level down to -96dB (otherwise the un-filtered sound from layer 2 will be audible as well as the filtered sound in layer 3). Now you can hear the Sync Square from layers 1 and 2 running through the filter in layer 3. See [Advanced Use Of KVA Oscillators](#) below for examples of how to set and control modulation of filter parameters.

Advanced Use Of KVA Oscillators

Read the KVA sections above before moving on to this section.

If you have tried the program described above in [Basic Use of KVA Oscillators](#), you may have noticed that there is no variation in the notes played aside from pitch. Layers and programs created with KVA oscillators can become much more expressive by introducing variation with DSP modulation. For a KVA oscillator layer, you can use DSP modulation just as you would for keymap layers (see [The DSP Modulation \(DSP MOD\) Page](#), and [The DSP Control \(DSP CTL\) Page](#)). Several KVA oscillators also have their own modulation parameters that must be accessed to control the oscillator's intended function. Aside from these methods, KVA layers can also be altered by using keymaps with natural amplitude envelopes. See below for details on each method.

Examples of Simple DSP Control and Modulation

Select the Program 2046 Editor Template and press the EDIT soft button. Go to the KEYMAP page and set Keymap to 999 Silence. Next, go to the AMP ENV page and set the mode to User, set Att1 time to .002 and Rel1 time to 0.02 (this gives you basic control of attack and release envelopes with sliders 3 and 4). Press the ALG soft button and select Algorithm 8. Select the leftmost empty function block and use the alpha wheel to scroll to the PWM oscillator. Play some notes to hear the sound of the PWM oscillator.

Select the right most empty function block and use the alpha wheel to scroll to the LOPASS block. You should immediately hear a difference in the sound of the program, because the LOPASS function is set by default to cut some of the high frequencies from any signal that passes through it, in this case the PWM signal is passing through. With the LOPASS function still selected, press the EDIT button. This brings you to the main parameter for the LOPASS object on the DSP CTL page, which is LP Frq (you can also reach this page using the DSP CTL soft button). Here you can adjust the initial value of the function, in this case

Program Edit Mode

Editing VAST Programs With KVA Oscillators

it is cut off frequency for the low pass filter. For this example, leave this initial value set to its default. With the LP Frq parameter selected, press right on the cursor button to get to this function's sub page (the right half of the display). Select the Veltrk parameter and use the alpha wheel or alpha numeric pad to turn it all the way up to 10800ct. Now keyboard velocities will affect the LP Frq parameter. A velocity of 127 will cause the filter's cut off frequency to move up 10800 cents from its initial value, a velocity of 0 will have no effect on the cut off frequency, and values in between will increase the cut off frequency by a scaling between 0 and 10800 cents. Overall, this will cause higher played velocities to increase the cut off frequency, making the oscillator sound brighter, and lower velocities to lower the cut off frequency, making the oscillator sound duller. This method can be used to control any DSP function that is loaded into an algorithm. See [The DSP Control \(DSP CTL\) Page on page 3-54](#) for other control parameters available on the DSP CTL page.

Alternatively, you could assign cut off frequency to be controlled by any continuous controller, such as the Mod Wheel. Start again with the unedited Program 2046 Editor Template. Follow the same steps as above, but instead of changing any parameters on the DSP CTL page, press the DSP MOD soft button to reach the DSP Modulation page. On the left side of the screen, choose the parameter for LP Frq, and then press the right cursor button to reach the LP Frq sub page. On this sub page, you can assign any continuous controller to control the cut off frequency of the LOPASS function (or the main parameter for any function loaded in the current algorithm). Select the Source 1 parameter, hold the ENTER button and move the Mod Wheel to quickly select MWheel (the Mod Wheel) as your control source. Next, press the cursor down button to select the Depth parameter, then use the alpha wheel or alpha numeric pad to turn it all the way up to 10800ct. Now the Mod Wheel will affect the LP Frq parameter. Moving the Mod Wheel all the way up (a value of 127) will cause the filter's cut off frequency to move up 10800 cents from its initial value, moving the Mod Wheel all the way down (a value of 0) will have no effect on the cut off frequency, and values in between will increase the cut off frequency by a scaling between 0 and 10800 cents. Now you have the same control over cut off frequency as you did in the previous example, but now it is controlled by the Mod Wheel. Overall, moving the Mod Wheel up will increase the cut off frequency, making the oscillator sound brighter, and moving the Mod Wheel down will lower the cut off frequency, making the oscillator sound duller. This is useful to control a classic "filter sweep" sound. The above method can be used to control any DSP function that is loaded into an algorithm, and you can choose any continuous controller as a control source.

Oscillator Specific Control And Modulation Parameters

Several KVA oscillators also have their own modulation parameters that must be accessed to control the oscillator's intended function. Below is a list of these oscillators and their distinctive parameters, grouped by block size. Though the following parameters could be left at one setting, utilizing one of the DSP CTL or DSP MOD techniques described in the above examples will expose a wider range of expression from each oscillator.

1 Block:

LPNOIZ

A noise generator combined with a low pass filter. Use the Noiz Frq parameter to control the cut off frequency of the filter.

NOISE

A simple noise generator. Use the Noise parameter to control the noise initial amplitude.

SW + SHP (Sawtooth + Shaper)

This oscillator combines a dull sawtooth waveform with an input signal, and passes the input signal through a shaper effect, which can produce timbres similar to FM synthesis. When this oscillator is placed after the sound source in an algorithm (either a keymap or another oscillator), changing the Pch Coar parameter can radically change the sound of the input signal. It can be useful to place a 1 block gain function before this oscillator, in order to control the depth of the shaper effect.

SINE+ [Aliased (not recommended)]

Same as 2 block version, but without the Sine+Am parameter.

SAW+ [Aliased (not recommended)]

A saw oscillator that can add an input signal to its output.

NOISE+ [Aliased (not recommended)]

A noise oscillator that can add an input signal to its output.

2 Block:

SINE+

A sine oscillator that can add an input signal to its output. The Sin+ Pch and Sine+ Am parameters affect the pitch and amplitude of the sine waveform without affecting the pitch of the input source.

RES NOISE

A noise generator combined with a low pass filter with resonance control. Use the Noiz Frq parameter to control the cut off frequency of the filter. Use the Noiz Q parameter to control the amplitude of the resonance (a boost or cut at the cut off frequency). One technique for use of this function is to set a high value for Noiz Q (so that you hear the resonance create a tone), and then on the DSP CTL page set C4 as an initial frequency for Noiz Frq, and set Keytrk to 100ct/key on the Noiz Frq sub page. Doing this causes the noise resonance frequency to match the note of the key played.

Program Edit Mode

Editing VAST Programs With KVA Oscillators

SHAPED SAW

The Shaped Saw oscillator is a sawtooth oscillator with the ability to morph its output shape between sawtooth and sine wave (without crossfading). This oscillator's distinctive parameter is Shape, which controls the morphing. With Shape set to 0, the oscillator produces a pure sawtooth wave. With Shape set to 127, the oscillator produces a pure sine wave. Values in between morph between the two wave shapes.

PWM (Pulse Width Modulation) [Aliased (not recommended)]

This oscillator's distinctive parameter is PWM Wid, which adjusts pulse width from values of 1-99. With PWM Wid set to a value of 50, PWM produces a square wave. The further the PWM Wid parameter is set from 50, the narrower the pulse width becomes, changing the shape of the output waveform and thus altering the oscillator's tonal quality.

FM OPERATOR / FM SAW OPERATOR / FM TRI OPERATOR

These oscillators are capable of basic Frequency Modulation synthesis, by using a sine, sawtooth, or triangle wave carrier signal which can be modulated by an input signal. Frequency modulation allows for the creation of complex timbres by rapidly modulating the frequency of a carrier signal with an input signal. These oscillators must be placed after the sound source in an algorithm (either keymap or oscillator) to hear the intended effect.

Use the FM Op Inp parameter to adjust the level of the input signal and frequency modulation depth. Try adjusting the FM Op Inp parameter to hear the input source modulate the carrier signal and find interesting timbres. When FM Op Inp is set to a low value, only the sine, sawtooth, or triangle wave carrier signal will be heard. As the input signal level is turned up, the operator will create brighter timbres. Input signals with complex or noisy timbres will more easily create noisy timbres, so the FM Op Inp parameter may need to be turned down. Input signals with simple timbres may be too quiet to apply modulation, so the FM Op Inp parameter may need to be turned up.

3 Block:

PWM (Pulse Width Modulation) [Anti-Aliased (recommended)]

Same as 2 Block PWM, See above.

4 Block:

SYNC SAW

Sync Saw consists of two saw waves, one that you hear (the slave) and one that controls the slave (the master). This oscillator's distinctive parameter is SyncOff, which controls the offset of the slave and master waves. With SyncOff set to 0, the master has no effect on the slave. When an offset is set, the slave restarts its wave cycle every time the master wave completes a cycle. Offsets cause the slave to restart its cycle in the middle of normal sawtooth cycles, which causes the slave's waveform shape and sound to be altered.

SUPER SAW

The Super Saw oscillator consists of two saw waves. This oscillator's distinctive parameter is Detune, which has settings from 0-50 cents, allowing you to detune both of the saw waves by up to 50 cents away from the root pitch of the key played. Detune affects both saw waves, one is detuned above the original root pitch, and the other is detuned below the original root pitch.

TRIPLE SAW

The Triple Saw oscillator consists of three saw waves. This oscillator's distinctive parameter is Detune, which has settings from 0-50 cents, allowing you to detune two of the saw waves by up to 50 cents away from the root pitch of the key played. Detune affects two of the saw waves, one is detuned above the original root pitch, and the other is detuned below the original root pitch. The third saw wave always plays the root pitch and is not affected by Detune.

8 Block:

SYNC SQUARE (master) >>, >>SYNC SQUARE (slave)

See above, [Setting Up The Sync Square Oscillator](#).

Use Of Keymaps and Natural Amplitude Envelopes With KVA Oscillators:

Keymaps are important in layers using KVA oscillators, even though their samples are not usually heard in these layers (see the note below for exceptions). Keymap selection is important because the maximum amplitude set for each key in the keymap is applied to the oscillator. For most uses of KVA oscillators, users will want to use the 999 Silence keymap because each key in the keymap is set to the same maximum amplitude, unlike many instrument keymaps. The 999 Silence keymap ensures uniform amplitude behavior of an oscillator, and with the amplitude envelope set to user mode, users can easily shape all aspects of an oscillator's amplitude. The PC4 also has the ability to apply natural amplitude envelopes to oscillators. With an amplitude envelope set to natural mode, each oscillator note takes on the amplitude qualities of each sample in a keymap (with each note relative to sample key placement). Each sample in a keymap has a natural envelope that was created during its original development process. Natural envelopes have much more detail than what is possible to create with the user amplitude envelope, and they are useful when trying to mimic specific instrument amplitude envelopes. When using this technique, remember that the maximum amplitude of each key is set by the current keymap. You can still control the overall parameters of a natural envelope by using the AMP ENV page.



Note: The samples from a keymap are not heard when using an oscillator, unless an algorithm is used to route the keymap signal around the oscillator and into a MIX function block, or unless it is an oscillator that processes its audio input.

Editing FM Layers

FM layers can be used to emulate classic FM synthesizers by using 6 Operators in 1 of 32 algorithms. FM layers also allow FM synthesis techniques to be combined with VAST synthesis features to create never before heard sounds.

FM layers contain pages that are not available in VAST layers. This includes the FM Main page, the FM Operator page, the FM Layer page, the FM Amp + Output Page, the FM Alt Input Page, and the FM Operator Mute Page. See the sections below for details on each of these pages. The remaining pages in FM layers are common to FM and VAST layers. For descriptions of these pages see the relevant VAST sections of this chapter.



Note: The PC4 can load .SYX files containing FM programs from classic 6 operator FM synthesizers. Imported FM programs can be edited in Program Mode and combined with additional layers and VAST synthesis features. For details on loading files see [“LOAD” on page 9-19](#).

FM Layer Structure

Each FM layer contains 6 Operators in 1 of 32 algorithms. The 6 Operators are the primary sound source in FM layers. Each Operator contains an oscillator with amplitude controlled by an envelope generator. FM synthesis allows you to modulate the frequency of the Operators in order to create many timbres.



Note: Each note played by an FM Layer uses 4 of the PC4's 256 voices.

FM MAIN Page

In FM layers, the FM Main page allows you to edit the main parameters of each FM Operator in the layer.

The parameters for each Operator are shown on the page in rows. The left hand column shows the Operator number for each row. Use the navigation buttons to select each row and parameter.

Op Level	Mode	Frequency	R1	L1	R2	L2	R3	L3	R4	L4
1: 99	Ratio	1.000	98	99	30	75	26	0	50	0
2: 71	Ratio	12.000	98	99	43	75	27	0	50	0
3: 99	Ratio	1.000	98	99	20	95	22	0	50	0
4: 80	Ratio	0.500	98	99	29	95	22	0	50	0
5: 99	Ratio	1.000	98	99	20	95	21	0	50	0
6: 87	Ratio	1.000	98	99	29	95	22	0	50	0

Alg

Use the Alg parameter to select 1 of 32 algorithms. Each algorithm changes how the Operators are connected to one another, determining which operators are heard as audio signals, and which are used as modulation sources.

The algorithm diagram to the right of the Alg parameter shows each Operator as a numbered box, with lines between each operator to show how they are connected.

The Operator or Operators in the bottom row of the diagram are heard as audio. Operators in higher rows are used as modulation sources. Modulation sources can also be modulated by other Operators in higher rows.

Each algorithm also shows a line determining the feedback path, in which the output of an Operator is used as its own modulation source, or as a modulation source for Operators in higher rows.

Level

Use the Level parameter to set the output level of each Operator.

Mode

Use the Mode parameter to set the frequency Mode of each Operator.

When Mode is set to Ratio, the frequency of the Operator is determined by each note played on the keyboard (in combination with the Frequency parameter). This is useful for melodic sounds.

When Mode is set to Fixed, the frequency of the Operator is determined by the Frequency parameter. This is useful for percussive sounds.

Frequency

Use the Frequency parameter to set the frequency of each Operator.

When Mode is set to Ratio, the frequency of the Operator is determined by each note played on the keyboard. Use the Frequency parameter to set the Ratio at which the frequency is changed.

When Mode is set to Fixed, the frequency of the Operator is determined by the Frequency parameter.

Operator Envelope Generator Parameters

Each Operator contains an envelope generator which controls the output level of the Operator. Use the Operator envelope generator parameters to control the output level of the Operator over time.

For Operators in the bottom row of the Algorithm diagram, changes to the output level of the Operator are heard as changes in audio level (similar to an amplitude envelope).

For Operators in higher rows of the Algorithm diagram, changes to the output level of the Operator are heard as changes in modulation depth.

R1, L1

When a note is played, the R1 parameter determines the rate at which the Operator output level changes from 0 (silence or no modulation) to the level set by L1.

The R1 parameter can be set to rate values from 0-99. Smaller rates make changes happen slowly, while larger rates make changes happen quickly.

The L1 parameter can be set to values from 0-99, where 0 is equivalent to silence or no modulation, and 99 is equivalent to the maximum possible Operator volume or modulation depth.

R2, L2

When a note is played and the Operator has reached the L1 level, the Operator level begins to change to the level set by the L2 parameter. The R2 parameter determines the rate at which the Operator output level changes from the L1 level to the level set by L2.

The R2 parameter can be set to rate values from 0-99. Smaller rates make changes happen slowly, while larger rates make changes happen quickly.

The L2 parameter can be set to values from 0-99, where 0 is equivalent to silence or no modulation, and 99 is equivalent to the maximum possible Operator volume or modulation depth.

R3, L3

When a note is played and the Operator has reached the L2 level, the Operator level begins to change to the level set by the L3 parameter. The R3 parameter determines the rate at which the Operator output level changes from the L2 level to the level set by L3.

The Operator remains at the level set by the L3 parameter for as long as a note is held.

The R3 parameter can be set to rate values from 0-99. Smaller rates make changes happen slowly, while larger rates make changes happen quickly.

The L3 parameter can be set to values from 0-99, where 0 is equivalent to silence or no modulation, and 99 is equivalent to the maximum possible Operator volume or modulation depth.

R4, L4

When a note is played and released, the Operator level begins to change to the level set by the L4 parameter. The R4 parameter determines the rate at which the Operator output level changes from its current level to the level set by L4.

The R4 parameter can be set to rate values from 0-99. Smaller rates make changes happen slowly, while larger rates make changes happen quickly.

The L4 parameter can be set to values from 0-99, where 0 is equivalent to silence or no modulation, and 99 is equivalent to the maximum possible Operator volume or modulation depth.



Note: When the L4 parameter is set to values 1-99, Operator level will always eventually change to a level of 0 (silence or no modulation), as if L4 was set to 0. Larger L4 values make changes happen slowly, while smaller L4 values make changes happen more quickly. This prevents infinitely sustaining notes which can occur in classic FM synthesizers.

FM Operator Page

In FM layers, the FM Operator page allows you to edit additional parameters of each FM Operator in the layer.

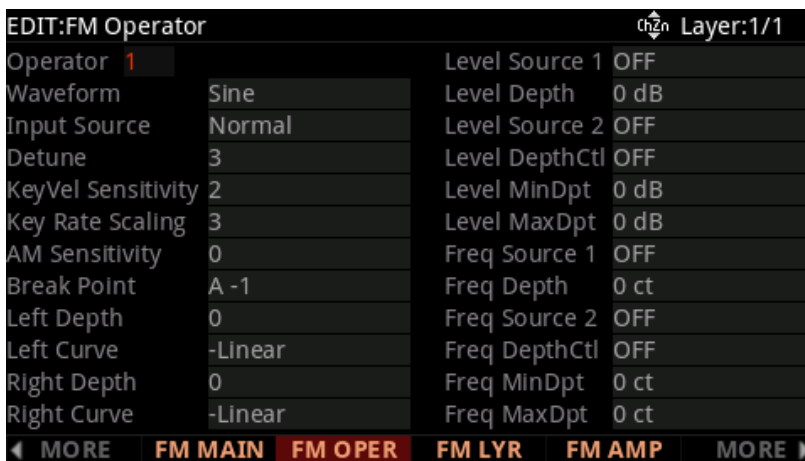

Operator

Use the Operator parameter to select an Operator. The parameters for the selected Operator are displayed.

Waveform

Use the Waveform parameter to select a waveform for the oscillator of the selected Operator. In classic FM synthesis, sine waveforms are used. Using waveforms other than sine can be useful for easily creating more complex timbres.

Input Source

Use the Input Source parameter to select an input for the selected Operator.

When Input Source is set to Normal, the selected Operator receives input from Operators in the selected FM Algorithm, depending on the connections in the selected FM Algorithm.

When Input Source is set to Keymap, the selected Operator receives input from the layer's Keymap (selected on the Keymap page). You can adjust additional Keymap parameters on the FM Alt Input page.

When Input Source is set to Alt, the selected Operator can receive input from another layer in the Program. When Input Source is set to Alt, you must select a source layer by using the Src Layer on the FM Alt Input page.

Detune

Use the Detune parameter to adjust fine tuning for the frequency of the selected Operator. This is useful for creating a chorus effect by applying different Detune values to Operators which are set to the same frequency.

KeyVel Sensitivity

Use the KeyVel Sensitivity parameter to adjust velocity sensitivity for the selected Operator. Velocity sensitivity makes the velocity of each note change the output level of the selected Operator. When an Operator is being used as an audio source, changes in Operator output level are heard as changes in volume. When an Operator is being used as a modulation source, changes in Operator output level are heard as changes in modulation depth.

KeyVel Sensitivity can be set to values from 0-7, where 0 is not velocity sensitive, 1 is the least velocity sensitive, and 7 is the most velocity sensitive.

When KeyVel Sensitivity is set to 0, the selected Operator always uses the output level set for the Operator on the FM Main page.

When KeyVel Sensitivity is set to 1-7, the selected Operator uses the output level set for the Operator on the FM Main page when a note is played with the highest possible velocity. Notes with lower velocities will set the Operator to a lower output level.

When KeyVel Sensitivity is set to 1, the Operator level is the least sensitive to velocity. Notes with low velocities will set the Operator to a slightly lower output level.

When KeyVel Sensitivity is set to 7, the Operator level is the most sensitive to velocity. Notes with low velocities will set the Operator to a much lower output level.



Note: The Global Mode FM Velocity parameter can be used to change the velocity resolution of all FM layers between 0-99 or 0-127. For details see [“FM Velocity” on page 9-9](#).

Key Rate Scaling

Use the Key Rate Scaling parameter to adjust Key Rate Scaling for the selected Operator. Key Rate Scaling makes the Envelope Generator rates of the selected Operator faster as higher notes are played. This is useful for emulating acoustic string and percussion instruments in which higher pitched notes are often shorter.

Key Rate Scaling can be set to values from 0-7, where 0 applies no scaling, 1 applies the least scaling, and 7 applies the most scaling.

AM Sensitivity

Use the AM Sensitivity parameter to adjust amplitude modulation sensitivity for the selected Operator. Amplitude modulation sensitivity controls the amplitude modulation depth of the LFO for the selected Operator. When an Operator is being used as an audio source, changes in Operator amplitude are heard as changes in volume. When an Operator is being used as a modulation source, changes in Operator amplitude are heard as changes in modulation depth.

AM Sensitivity can be set to values from 0-3, where 0 applies no amplitude modulation, 1 applies the least amplitude modulation, and 3 applies the most amplitude modulation.

The AM Sensitivity parameter works in combination with the FM Layer Page Amp Mod Depth parameter. To apply amplitude modulation to an Operator, the FM Layer Page Amp Mod Depth parameter must be set to a value greater than 0.

Keyboard Level Scaling Parameters

Use the keyboard level scaling parameters to increase or decrease the output level of the selected Operator as higher or lower notes are played. A left and right curve can be applied allowing for separate scaling of high and low notes. Keyboard level scaling is useful for emulating acoustic instruments, in which higher and lower notes often have different volumes and timbres.

When an Operator is being used as an audio source, changes in Operator output level are heard as changes in volume. When an Operator is being used as a modulation source, changes in Operator output level are heard as changes in modulation depth.

Break Point

Use the Break Point parameter to select a keyboard key to serve as the start point for the left and right keyboard level scaling curves.

Left Depth, Right Depth

Use the Left Depth and Right Depth parameters to set the maximum modulation depth for the left or right keyboard level scaling curves.

Left Curve, Right Curve

Use the Left Curve and Right Curve parameters to set the left or right keyboard level scaling curves.

The -Linear and -Exponential settings progressively reduce Operator output level as notes are played further from the Break Point key, using a linear or exponential curve.

The +Linear and +Exponential settings progressively increase Operator output level as notes are played further from the Break Point key, using a linear or exponential curve.

Operator Level Parameters

The right-hand column of the FM Operator page shows Level modulation parameters for the selected Operator. Select an Operator with the Operator parameter to view its Level modulation parameters.

Level Source 1

Use the Level Source 1 parameter to modulate the Operator output Level with a physical controller or other control source.

Level Depth

Use the Level Depth parameter to set the maximum modulation depth of Level Source 1.

When the Level Source 1 control source is at its minimum value, Level Source 1 will have no effect on the Operator output Level.

When the Level Source 1 control source is at its maximum value, Level Source 1 will apply the amount of modulation set by the Level Depth parameter.

Level Source 1 control source values between the minimum and maximum will scale the amount of modulation between no effect and the amount set by the Level Depth parameter.

Level Source 2

Use the Level Source 2 parameter to modulate the Operator output Level with a physical controller or other control source.

Level DepthCtl

Use the Level DepthCtl parameter to modulate the Level Source 2 modulation depth with a physical controller or other control source.

When a Level DepthCtl control source is at its minimum value, the Level Source 2 modulation depth will be set to the value of the Level MinDpt parameter.

When a Level DepthCtl control source is at its maximum value, the Level Source 2 modulation depth will be set to the value of the Level MaxDpt parameter.

Level DepthCtl control source values between the minimum and maximum will scale the Level Source 2 modulation depth between the values of the Level MinDpt and Level MaxDpt parameters.

Level MinDpt

Use the Level MinDpt parameter to set the minimum modulation depth of Level Source 2.

When a Level DepthCtl control source is at its minimum value, Level Source 2 will apply the amount of modulation set by the Level MinDpt parameter.

Level MaxDpt

Use the Level MaxDpt parameter to set the maximum modulation depth of Level Source 2.

When a Level DepthCtl control source is at its maximum value, Level Source 2 will apply the amount of modulation set by the Level MaxDpt parameter.

Frequency Modulation Parameters

The right-hand column of the FM Operator page shows Frequency modulation parameters for the selected Operator. Select an Operator with the Operator parameter to view its Frequency modulation parameters.

Freq Source 1

Use the Freq Source 1 parameter to modulate the Operator Frequency with a physical controller or other control source.

Freq Depth

Use the Freq Depth parameter to set the maximum modulation depth of Freq Source 1.

When the Freq Source 1 control source is at its minimum value, Freq Source 1 will have no effect on the Operator Frequency.

When the Freq Source 1 control source is at its maximum value, Freq Source 1 will apply the amount of modulation set by the Freq Depth parameter.

Freq Source 1 control source values between the minimum and maximum will scale the amount of modulation between no effect and the amount set by the Freq Depth parameter.

Freq Source 2

Use the Freq Source 2 parameter to modulate the Operator Frequency with a physical controller or other control source.

Freq DepthCtl

Use the Freq DepthCtl parameter to modulate the Freq Source 2 modulation depth with a physical controller or other control source.

When a Freq DepthCtl control source is at its minimum value, the Freq Source 2 modulation depth will be set to the value of the Freq MinDpt parameter.

When a Freq DepthCtl control source is at its maximum value, the Freq Source 2 modulation depth will be set to the value of the Freq MaxDpt parameter.

Freq DepthCtl control source values between the minimum and maximum will scale the Freq Source 2 modulation depth between the values of the Freq MinDpt and Freq MaxDpt parameters.

Freq MinDpt

Use the Freq MinDpt parameter to set the minimum modulation depth of Freq Source 2.

When a Freq DepthCtl control source is at its minimum value, Freq Source 2 will apply the amount of modulation set by the Freq MinDpt parameter.

Freq MaxDpt

Use the Freq MaxDpt parameter to set the maximum modulation depth of Freq Source 2.

When a Freq DepthCtl control source is at its maximum value, Freq Source 2 will apply the amount of modulation set by the Freq MaxDpt parameter.

FM Layer Page



Transpose

Use the Transpose parameter to adjust tuning in semitones for all Operators in the layer.

Detune

Use the Detune parameter to adjust fine tuning for all Operators in the layer. This is useful for creating a chorus effect by applying different Detune values to multiple FM layers which are set to the same settings.

Feedback

Use the Feedback parameter to adjust the feedback level for the selected FM Algorithm.

Each algorithm shows a line determining the feedback path, in which the output of an Operator is used as its own modulation source, or as a modulation source for Operators in higher rows. Feedback is useful for creating square waveforms and noise.

Feedback can be set to values from 0-7, where 0 applies no feedback, 1 applies the least feedback, and 7 applies the most feedback.

Oscillator Key Sync

Use the Oscillator Key Sync parameter to turn oscillator key sync off or on.

When Oscillator Key Sync is set to On, the oscillator in each FM Operator resets its phase each time a note is played.

When Oscillator Key Sync is set to Off, the oscillator in each FM Operator does not reset its phase each time a note is played. In some programs this can be useful for adding subtle variations to each note played.

Amp Mod Depth

Use the Amp Mod Depth parameter to adjust amplitude modulation depth of the FM LFO for all FM Operators in the layer. When an Operator is being used as an audio source, changes in Operator amplitude are heard as changes in volume. When an Operator is being used as a modulation source, changes in Operator amplitude are heard as changes in modulation depth.

Amp Mod Depth can be set to values from 0-99, where 0 applies no amplitude modulation, 1 applies the least amplitude modulation, and 99 applies the most amplitude modulation.

The Amp Mod Depth parameter works in combination with the each Operator's AM Sensitivity parameter on the FM Operator Page. To apply amplitude modulation to an Operator, the FM Operator's AM Sensitivity parameter must be set to a value greater than 0 on the FM Operator Page.

Pitch Mod Depth

Use the Pitch Mod Depth parameter to make fine adjustments to pitch modulation depth of the FM LFO for all FM Operators in the layer. Pitch Mod Depth can be set to values from 0-99, where 0 applies no pitch modulation, 1 applies the least pitch modulation, and 99 applies the most pitch modulation.

The Pitch Mod Depth parameter works in combination with the Pitch Mod Sensitivity parameter. To apply pitch modulation the Pitch Mod Sensitivity parameter and Pitch Mod Depth parameter must both be set to a value greater than 0.

Pitch Mod Sensitivity

Use the Pitch Mod Sensitivity parameter to make coarse adjustments to pitch modulation depth of the FM LFO for all FM Operators in the layer. Pitch Mod Sensitivity can be set to values from 0-7, where 0 applies no pitch modulation, 1 applies the least pitch modulation, and 7 applies the most pitch modulation.

The Pitch Mod Sensitivity parameter works in combination with the Pitch Mod Depth parameter. To apply pitch modulation the Pitch Mod Sensitivity parameter and Pitch Mod Depth parameter must both be set to a value greater than 0.

FM LFO Speed

Use the FM LFO Speed parameter to set the speed of the FM LFO. FM LFO Speed can be set to values from 0-99, 0 is the slowest and 99 is the fastest.

FM LFO Shape

Use the FM LFO Shape to select an LFO shape for the FM LFO. The FM LFO can apply amplitude and pitch modulation to the FM Operators, see the Amp Mod Depth and Pitch Mod Depth parameters for details.

FM LFO Delay

Use the FM LFO Delay parameter to add a delay between when a note is played and when the FM LFO will apply modulation. FM LFO Delay can be set to values from 0-99, where 0 applies no delay, 1 applies the least delay, and 99 applies the most delay.

FM LFO Key Sync

Use the FM LFO Key Sync parameter to turn FM LFO key sync off or on.

When FM LFO Key Sync is set to On, the FM LFO resets its phase each time a note is played.

When FM LFO Key Sync is set to Off, the FM LFO does not reset its phase each time a note is played. In some programs this can be useful for adding variations to each note played.

Modwheel LFO->Pitch

The Modwheel LFO->Pitch parameter allows you to use the Modwheel or other physical controller to control the pitch modulation depth of the FM LFO for all FM Operators in the layer.

When the Modwheel is set to its minimum value, pitch modulation depth is determined by the Pitch Mod Depth parameter. When the Modwheel is set to its maximum value, pitch modulation depth equals the value of the Pitch Mod Depth parameter plus the value of the Modwheel LFO->Pitch parameter.

Modwheel values between the minimum and maximum will scale the amount of modulation between the value of the Pitch Mod Depth parameter and the value of the Pitch Mod Depth parameter plus the value of the Modwheel LFO->Pitch parameter.

Modwheel LFO->Pitch can be set to values from 0-99, where 0 applies no pitch modulation, 1 applies the least pitch modulation, and 99 applies the most pitch modulation.

The Modwheel LFO->Pitch parameter works in combination with the Pitch Mod Sensitivity parameter. To apply pitch modulation the Pitch Mod Sensitivity parameter and Modwheel LFO->Pitch parameter must both be set to a value greater than 0.

To use a physical controller other than the Modwheel, go to the Parameters page, select the FM Mod parameter, then select a different physical controller using the Control column.

Pressure LFO->Pitch

The Pressure LFO->Pitch parameter allows you to use keyboard pressure (aftertouch) to control the pitch modulation depth of the FM LFO for all FM Operators in the layer.

When keyboard pressure is at its minimum value, pitch modulation depth is determined by the Pitch Mod Depth parameter. When keyboard pressure is at its maximum value, pitch modulation depth equals the value of the Pitch Mod Depth parameter plus the value of the Pressure LFO->Pitch parameter.

Pressure values between the minimum and maximum will scale the amount of modulation between the value of the Pitch Mod Depth parameter and the value of the Pitch Mod Depth parameter plus the value of the Pressure LFO->Pitch parameter.

Pressure LFO->Pitch can be set to values from 0-99, where 0 applies no pitch modulation, 1 applies the least pitch modulation, and 99 applies the most pitch modulation.

The Pressure LFO->Pitch parameter works in combination with the Pitch Mod Sensitivity parameter. To apply pitch modulation the Pitch Mod Sensitivity parameter and Pressure LFO->Pitch parameter must both be set to a value greater than 0.

Modwheel LFO->Amp

The Modwheel LFO->Amp parameter allows you to use the Modwheel or other physical controller to control the amplitude modulation depth of the FM LFO for all FM Operators in the layer.

When the Modwheel is set to its minimum value, amplitude modulation depth is determined by the Amp Mod Depth parameter. When the Modwheel is set to its maximum value, amplitude modulation depth equals the value of the Amp Mod Depth parameter plus the value of the Modwheel LFO->Amp parameter.

Modwheel values between the minimum and maximum will scale the amount of modulation between the value of the Amp Mod Depth parameter and the value of the Amp Mod Depth parameter plus the value of the Modwheel LFO->Amp parameter.

Modwheel LFO->Amp can be set to values from 0-99, where 0 applies no amplitude modulation, 1 applies the least amplitude modulation, and 99 applies the most amplitude modulation.

The Modwheel LFO->Amp parameter works in combination with each Operator's AM Sensitivity parameter on the FM Operator Page. To apply amplitude modulation to an Operator, the FM Operator's AM Sensitivity parameter must be set to a value greater than 0 on the FM Operator Page.

To use a physical controller other than the Modwheel, go to the Parameters page, select the FM Mod parameter, then select a different physical controller using the Control column.

Pressure LFO->Amp

The Pressure LFO->Amp parameter allows you to use keyboard pressure (aftertouch) to control the amplitude modulation depth of the FM LFO for all FM Operators in the layer.

When keyboard pressure is at its minimum value, amplitude modulation depth is determined by the Amp Mod Depth parameter. When keyboard pressure is at its maximum value, amplitude modulation depth equals the value of the Amp Mod Depth parameter plus the value of the Pressure LFO->Amp parameter.

Pressure values between the minimum and maximum will scale the amount of modulation between the value of the Amp Mod Depth parameter and the value of the Amp Mod Depth parameter plus the value of the Pressure LFO->Amp parameter.

Pressure LFO->Amp can be set to values from 0-99, where 0 applies no amplitude modulation, 1 applies the least amplitude modulation, and 99 applies the most amplitude modulation.

The Pressure LFO->Amp parameter works in combination with each Operator's AM Sensitivity parameter on the FM Operator Page. To apply amplitude modulation to an Operator, the FM Operator's AM Sensitivity parameter must be set to a value greater than 0 on the FM Operator Page.

Pitch EG Parameters

Use the Pitch Envelope generator parameters to modulate the pitch of each note played by the layer over time. Pitch can be modulated by up to 4 octaves up and down from the original pitch of each note played.

All Rate parameters can be set to rate values from 0-99. Smaller rates make changes happen slowly, while larger rates make changes happen quickly.

All Level parameters can be set to values from 0-99, where 50 is equivalent to the original pitch of the note played or no modulation, 0 is equivalent to -48 half steps from the original pitch of the note played, and 99 is equivalent to +48 half steps from the original pitch of the note played.

Rate 1, Level 1

When a note is played, the Rate 1 parameter determines the rate at which the pitch changes from Level 4 to Level 1.

Rate 2, Level 2

When a note is played and the Pitch has reached Level 1, the Pitch begins to change to Level 2. The Rate 2 parameter determines the rate at which the pitch changes from Level 1 to Level 2.

Rate 3, Level 3

When a note is played and the pitch has reached Level 2, the pitch begins to change to Level 3. The Rate 3 parameter determines the rate at which the pitch changes from Level 2 to Level 3.

The pitch remains at Level 3 for as long as a note is held.

Rate 4, Level 4

When a note is played and released, the pitch begins to change to Level 4. The Rate 4 parameter determines the rate at which the pitch changes from its current pitch to Level 3.

FM Amp + Output Page

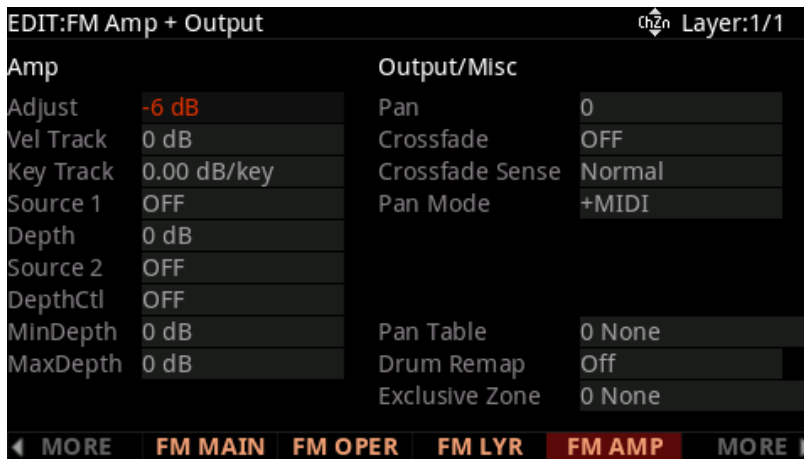

Amp Parameters

The left-hand column of the FM Amp + Output page shows amplitude modulation parameters for the layer. Use the left-hand column of the page to adjust and modulate the overall output level of the current FM layer.

Adjust

Use the Adjust parameter to set the overall output level of the current FM layer.

Vel Track

Use the Vel Track parameter to modulate the amplitude of each note in the layer based on the MIDI velocity of each note played.

Positive Vel Track values will progressively increase the amplitude for higher velocities. For example, with a positive Vel Track value, playing a velocity of 0 causes no change in amplitude, playing each velocity further above 0 increases the amplitude by the Vel Track amount.

Key Track

Use the Key Track parameter to modulate the amplitude of each note in the layer based on the MIDI note number of each note played.

Positive Key Track values will progressively increase amplitude for each note played above middle C, and progressively decrease amplitude for notes played below middle C. For example, with a positive Key Track value, playing middle C causes no change in amplitude, playing each key further above middle C increases the amplitude by the Key Track amount, and playing each key further below middle C decreases the amplitude by the Key Track amount.

Program Edit Mode

FM Amp + Output Page

Negative Key Track values will progressively decrease amplitude for each note played above middle C, and progressively increase amplitude for notes played below middle C. For example, with a negative Key Track value, playing middle C causes no change in amplitude, playing each key further above middle C decreases the amplitude by the Key Track amount, and playing each key further below middle C increases the amplitude by the Key Track amount.

Src1

Use the Src1 parameter to modulate the layer output level with a physical controller or other control source.

Depth

Use the Depth parameter to set the maximum modulation depth of Src1.

When the Src1 control source is at its minimum value, Src1 will have no effect on the layer output level.

When the Src1 control source is at its maximum value, Src1 will apply the amount of modulation set by the Depth parameter.

Src1 control source values between the minimum and maximum will scale the amount of modulation between no effect and the amount set by the Depth parameter.

Src2

Use the Src2 parameter to modulate the layer output level with a physical controller or other control source.

DptCtl

Use the DptCtl parameter to modulate the Src2 modulation depth with a physical controller or other control source.

When a DptCtl control source is at its minimum value, the Src2 modulation depth will be set to the value of the MinDpt parameter.

When a DptCtl control source is at its maximum value, the Src2 modulation depth will be set to the value of the MaxDpt parameter.

DptCtl control source values between the minimum and maximum will scale the Src2 modulation depth between the values of the MinDpt and MaxDpt parameters.

MinDpt

Use the MinDpt parameter to set the minimum modulation depth of Src2.

When a DptCtl control source is at its minimum value, Src2 will apply the amount of modulation set by the MinDpt parameter.

MaxDpt

Use the MaxDpt parameter to set the maximum modulation depth of Src2.

When a DptCtl control source is at its maximum value, Src2 will apply the amount of modulation set by the MaxDpt parameter.

Output/Misc Parameters

The right-hand column of the FM Amp + Output page shows Output/Misc parameters for the layer. The Output/Misc parameters for FM layers behave the same as the parameters on the VAST layer Output page. For details on these parameters see ["The OUTPUT Page" on page 3-58](#).

FM Alt Input Page

EDIT:FM Alt Input		Layer:1/1	
Alt Input Source/Level	Keymap Level	Keymap Pitch	
Src Layer None	Adjust 0 dB	Adjust	0 ST
Adjust 0 dB	Vel Track 0 dB	Vel Track	0 ct
Vel Track 0 dB	Key Track 0.00 dB/key	Fine	0 ct
Key Track 0.00 dB/key		Fine Hz	0.00 Hz
Source 1 OFF	Source 1 OFF	Source 1	OFF
Depth 0 dB	Depth 0 dB	Depth	0 ct
Source 2 OFF	Source 2 OFF	Source 2	OFF
DepthCtl OFF	DepthCtl OFF	DepthCtl	OFF
MinDpth 0 dB	MinDpth 0 dB	MinDpth	0 ct
MaxDpth 0 dB	MaxDpth 0 dB	MaxDpth	0 ct

◀ MORE AMP ENV ENV2 **FM INPUT** LFO+ MORE ▶

In classic FM synthesis, Operators containing sine wave oscillators are used to frequency modulate other Operators in various configurations in order to create complex timbres. FM layers allow you to use an alternate input for these Operators, allowing sources other than FM Operators to be used for modulation of other FM Operators. This is useful for easily creating complex timbres without complex configurations of Operators and modulation sources.

The FM alternate input allows FM Operators in the current layer to be modulated by a Keymap in the current layer, or by any type of audio signal from a different FM or VAST layer. FM synthesis techniques can be combined with VAST synthesis features to create never before heard sounds.

Modulating an FM Operator with a Keymap

Follow these steps to modulate an FM Operator with a Keymap in the current layer:

1. On the FM Operator page, use the Operator parameter to select an Operator to modulate.
2. On the FM Operator page, set the Input Source parameter for the selected Operator to Keymap.
3. On the Keymap page, use the Keymap parameter to select a Keymap.
4. On the FM Alt Input page, use the Keymap Level parameters to adjust the keymap level. The keymap level determines the amount of modulation applied to the selected Operator.
5. Try adjusting the Keymap Level Adjust parameter to find interesting timbres. If the Keymap level is too low, no modulation will be applied. If the Keymap level is too high, the Operator will create noisy timbres. Keymaps with complex or noisy timbres will more easily create noisy timbres when used as a modulation source, so for these Keymaps the Adjust parameter may need to be turned down. Keymaps with simple timbres may be too quiet to apply modulation, so for these Keymaps the Adjust parameter may need to be turned up.
6. Try using the Keymap Level Source 1 and Source 2 parameters to modulate the Keymap level with a physical controller or other control source. This often leads to more interesting sounds.

Modulating an FM Operator with another Layer

Follow these steps to modulate an FM Operator with an audio signal from a different FM or VAST layer:

1. On the FM Operator page, use the Operator parameter to select an Operator to modulate.
2. On the FM Operator page, set the Input Source parameter for the selected Operator to Alt.
3. On the FM Alt Input page, use the Src Layer parameter to select another layer in the Program. The current Program must have more than one layer.
4. On the FM Alt Input page, use the Alt Input Source/Level parameters to adjust the Alt Input level. The Alt Input level determines the amount of modulation applied to the selected Operator.

5. Try adjusting the Alt Input Source/Level Adjust parameter to find interesting timbres. If the Alt Input level is too low, no modulation will be applied. If the Alt Input level is too high, the Operator will create noisy timbres. Audio signals with complex or noisy timbres will more easily create noisy timbres when used as a modulation source, so for these signals the Adjust parameter may need to be turned down. Audio signals with simple timbres may be too quiet to apply modulation, so for these signals the Adjust parameter may need to be turned up.
6. Try using the Alt Input Source/Level Source 1 and Source 2 parameters to modulate the Alt Input level with a physical controller or other control source. This often leads to more interesting sounds.

Alt Input Source/Level Parameters

Src Layer

Use the Src Layer parameter to select another layer in the Program to use its audio output signal as a modulation source for FM Operators. The current Program must have more than one layer.

To use the selected source layer as a modulation source, select an Operator on the FM Operator page and set the Input Source parameter to Alt.

Adjust

Use the Adjust parameter to set the output level of the selected Alt Input source layer.

Vel Track

Use the Vel Track parameter to modulate the amplitude of each note of the Alt Input source layer based on the MIDI velocity of each note played.

Positive Vel Track values will progressively increase the amplitude for higher velocities. For example, with a positive Vel Track value, playing a velocity of 0 causes no change in amplitude, playing each velocity further above 0 increases the amplitude by the Vel Track amount.

Key Track

Use the Key Track parameter to modulate the amplitude of each note of the Alt Input source layer based on the MIDI note number of each note played.

Positive Key Track values will progressively increase amplitude for each note played above middle C, and progressively decrease amplitude for notes played below middle C. For example, with a positive Key Track value, playing middle C causes no change in amplitude, playing each key further above middle C increases the amplitude by the Key Track amount, and playing each key further below middle C decreases the amplitude by the Key Track amount.

Program Edit Mode

FM Alt Input Page

Negative Key Track values will progressively decrease amplitude for each note played above middle C, and progressively increase amplitude for notes played below middle C. For example, with a negative Key Track value, playing middle C causes no change in amplitude, playing each key further above middle C decreases the amplitude by the Key Track amount, and playing each key further below middle C increases the amplitude by the Key Track amount.

Source 1

Use the Source 1 parameter to modulate the Alt Input source layer output level with a physical controller or other control source.

Depth

Use the Depth parameter to set the maximum modulation depth of Source 1.

When the Source 1 control source is at its minimum value, Source 1 will have no effect on the Alt Input source layer output level.

When the Source 1 control source is at its maximum value, Source 1 will apply the amount of modulation set by the Depth parameter.

Source 1 control source values between the minimum and maximum will scale the amount of modulation between no effect and the amount set by the Depth parameter.

Source 2

Use the Source 2 parameter to modulate the Alt Input source layer output level with a physical controller or other control source.

DepthCtl

Use the DepthCtl parameter to modulate the Source 2 modulation depth with a physical controller or other control source.

When a DepthCtl control source is at its minimum value, the Source 2 modulation depth will be set to the value of the MinDpth parameter.

When a DepthCtl control source is at its maximum value, the Source 2 modulation depth will be set to the value of the MaxDpth parameter.

DepthCtl control source values between the minimum and maximum will scale the Source 2 modulation depth between the values of the MinDpth and MaxDpth parameters.

MinDpth

Use the MinDpth parameter to set the minimum modulation depth of Source 2.

When a DepthCtl control source is at its minimum value, Source 2 will apply the amount of modulation set by the MinDpth parameter.

MaxDpth

Use the MaxDpth parameter to set the maximum modulation depth of Source 2.

When a DepthCtl control source is at its maximum value, Source 2 will apply the amount of modulation set by the MaxDpth parameter.

Keymap Level Parameters

Adjust

Use the Adjust parameter to set the output level of the Keymap.

Vel Track

Use the Vel Track parameter to modulate the amplitude of each note of the Keymap based on the MIDI velocity of each note played.

Positive Vel Track values will progressively increase the amplitude for higher velocities. For example, with a positive Vel Track value, playing a velocity of 0 causes no change in amplitude, playing each velocity further above 0 increases the amplitude by the Vel Track amount.

Key Track

Use the Key Track parameter to modulate the amplitude of each note of the Keymap based on the MIDI note number of each note played.

Positive Key Track values will progressively increase amplitude for each note played above middle C, and progressively decrease amplitude for notes played below middle C. For example, with a positive Key Track value, playing middle C causes no change in amplitude, playing each key further above middle C increases the amplitude by the Key Track amount, and playing each key further below middle C decreases the amplitude by the Key Track amount.

Negative Key Track values will progressively decrease amplitude for each note played above middle C, and progressively increase amplitude for notes played below middle C. For example, with a negative Key Track value, playing middle C causes no change in amplitude, playing each key further above middle C decreases the amplitude by the Key Track amount, and playing each key further below middle C increases the amplitude by the Key Track amount.

Source 1

Use the Source 1 parameter to modulate the Keymap output level with a physical controller or other control source.

Depth

Use the Depth parameter to set the maximum modulation depth of Source 1.

When the Source 1 control source is at its minimum value, Source 1 will have no effect on the Keymap output level.

When the Source 1 control source is at its maximum value, Source 1 will apply the amount of modulation set by the Depth parameter.

Source 1 control source values between the minimum and maximum will scale the amount of modulation between no effect and the amount set by the Depth parameter.

Source 2

Use the Source 2 parameter to modulate the Keymap output level with a physical controller or other control source.

DepthCtl

Use the DepthCtl parameter to modulate the Source 2 modulation depth with a physical controller or other control source.

When a DepthCtl control source is at its minimum value, the Source 2 modulation depth will be set to the value of the MinDpth parameter.

When a DepthCtl control source is at its maximum value, the Source 2 modulation depth will be set to the value of the MaxDpth parameter.

DepthCtl control source values between the minimum and maximum will scale the Source 2 modulation depth between the values of the MinDpth and MaxDpth parameters.

MinDpth

Use the MinDpth parameter to set the minimum modulation depth of Source 2.

When a DepthCtl control source is at its minimum value, Source 2 will apply the amount of modulation set by the MinDpth parameter.

MaxDpth

Use the MaxDpth parameter to set the maximum modulation depth of Source 2.

When a DepthCtl control source is at its maximum value, Source 2 will apply the amount of modulation set by the MaxDpth parameter.

Keymap Pitch Parameters

Adjust

Use the Adjust parameter to adjust the pitch of the Keymap in half steps.

Vel Track

Use the Vel Track parameter to modulate the pitch of each note of the Keymap based on the MIDI velocity of each note played.

Positive Vel Track values will progressively increase the pitch for higher velocities. For example, with a positive Vel Track value, playing a velocity of 0 causes no change in pitch, playing each velocity further above 0 increases the pitch by the Vel Track amount.

Fine

Use the Fine parameter to adjust the pitch of the Keymap in cents.

Fine Hz

Use the Adjust parameter to adjust the pitch of the Keymap in Hertz.

Source 1

Use the Source 1 parameter to modulate the Keymap pitch with a physical controller or other control source.

Depth

Use the Depth parameter to set the maximum modulation depth of Source 1.

When the Source 1 control source is at its minimum value, Source 1 will have no effect on the Keymap pitch.

When the Source 1 control source is at its maximum value, Source 1 will apply the amount of modulation set by the Depth parameter.

Source 1 control source values between the minimum and maximum will scale the amount of modulation between no effect and the amount set by the Depth parameter.

Source 2

Use the Source 2 parameter to modulate the Keymap pitch with a physical controller or other control source.

Program Edit Mode

FM Operator Mute Page

DepthCtl

Use the DepthCtl parameter to modulate the Source 2 modulation depth with a physical controller or other control source.

When a DepthCtl control source is at its minimum value, the Source 2 modulation depth will be set to the value of the MinDpth parameter.

When a DepthCtl control source is at its maximum value, the Source 2 modulation depth will be set to the value of the MaxDpth parameter.

DepthCtl control source values between the minimum and maximum will scale the Source 2 modulation depth between the values of the MinDpth and MaxDpth parameters.

MinDpth

Use the MinDpth parameter to set the minimum modulation depth of Source 2.

When a DepthCtl control source is at its minimum value, Source 2 will apply the amount of modulation set by the MinDpth parameter.

MaxDpth

Use the MaxDpth parameter to set the maximum modulation depth of Source 2.

When a DepthCtl control source is at its maximum value, Source 2 will apply the amount of modulation set by the MaxDpth parameter.

FM Operator Mute Page

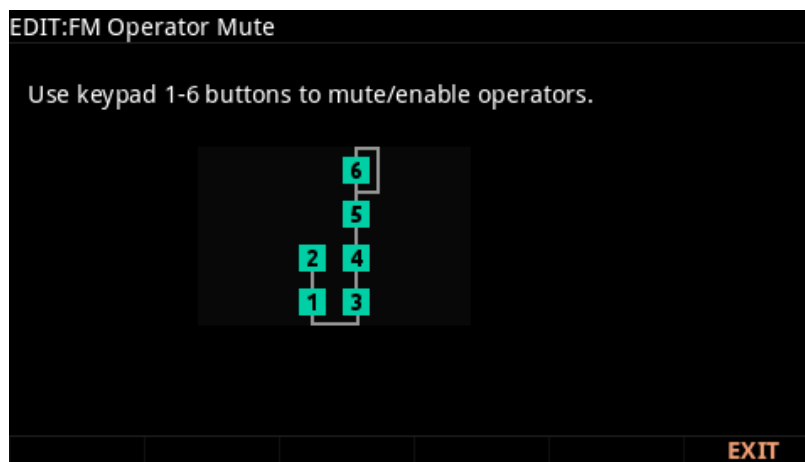

When editing an FM layer, press the Multi Mode button to view the FM Operator Mute page. The FM Operator Mute page allows you to temporarily mute FM operators while editing, which can be useful for hearing the effect that each operator has in the selected algorithm. Use the Keypad 1-6 buttons to mute or enable operators 1-6 in the displayed algorithm, muted operators turn gray. When a program is saved, all operators are enabled.

Editing KB3 Programs

The display shows the KB3 icon when a KB3 Program is selected. Enter the KB3 program editor by pressing the EDIT soft button while a KB3 program is selected in program mode.

You can play KB3 programs only on a single channel at a time.

KB3 Program Structure

There's nothing quite like the sound of the classic tone wheel organ, especially when played through a rotary speaker system. We've done extensive testing and analysis with several tone wheel organs, and created our own models to emulate the unique tone wheel sound. We even took into account the way that older organs start to sound different (and arguably better) as their capacitors begin to leak—and we included a parameter that lets you vary the amount of grunge (leakage) in your sound.

KB3 programs use oscillators to emulate the tone wheel sound. Each oscillator operates independently, and has its own pitch and amplitude control. You can control how many oscillators are used for a KB3 program. There are two oscillators per voice, for a total of 256. You can use up to 91 of them in a KB3 program (the 92nd is reserved to produce key click). Because the oscillators start running as soon as you select a KB3 program, there are always voices available—unlike VAST programs, which start “stealing” notes when you reach the polyphony limit.

The oscillators—we'll call them tone wheels from here on—are divided into an upper and lower group. The upper tone wheels use the samples in the PC4's keymaps to generate sound, while the lower tone wheels use sine waves. You can change the keymap of a KB3 program's upper tone wheels to produce a large array of sounds. By changing the keymap from sine to a saw wave it is possible to emulate the sound of classic combo organs.

Octave folding, where an octave (or part of an octave) is repeated at the top or bottom of the keyboard, is handled automatically by KB3 programs, emulating the folding done on actual tone wheel organs.

KB3 programs are also routed through vibrato, rotary speaker, preamp and distortion effects, see below for details.

KB3 Effects And Real-time Controls

You have real-time control over many components of KB3 programs directly from the front panel. The sliders emulate the drawbars that are so essential to the tone wheel sound, while the buttons below them can control the KB3 effects: rotary, vibrato, chorus, and percussion.

Program Edit Mode

Editing KB3 Programs

Drawbars

One of the standard performance features of many tone wheel organs is the set of drawbars for emulating the stops on a pipe organ. Moving the drawbars controls the amplitude of either the fundamentals or the harmonics of the notes. The PC4's sliders serve as the nine drawbars found on most tone wheel organs. Pushing the sliders up is the equivalent of pushing the drawbars in (removing fundamentals or harmonics).

Buttons

When using a KB3 program, the buttons below the sliders control KB3 effects. Each button is labeled with a KB3 function, and their LEDs indicate the status of each effect.

Use the Variation button to toggle the Rotary speed between slow or fast.

Chorus and Vibrato each have 3 levels of depth. Depth 1 has the least amount of effect applied, Depth 3 has the most. Pressing the Chorus/Vibrato Depth button toggles between Depth 1 (LED off) and Depth 3 (LED on). You can also set the depth on the KB3 Parameters page using the **Chorus/Vibrato Depth** parameter. Values 0-42 = Depth 1, 43-85 = Depth 2, 86-127 = Depth 3.

Additional KB3 Controller Assignments

Other default assignments for factory KB3 programs include:

CC Pedal 1 (volume) controls preamp volume, which emulates the volume control of an organ preamp. The Preamp Resp parameter must be set to On for this to work (the default setting). See [Preamp Resp on page 3-110](#) for details.

Mod Wheel controls Distortion Drive.

Switch Pedal 1 (sustain) controls the rotary speaker effect, which toggles the Rotary speed between slow or fast. This has the same effect as using Rotary S/F (**Variation** button).

KB3 Programming Tips

The following section provides some starting points for creating your own KB3 programs.

The most prominent difference between organ vintages is the number of tone wheels used. Keep in mind, however, that the sound of an actual tone wheel organ will depend not only on its age, but also on how well it has been maintained.

Early Tone Wheel Organs. Instruments of this period had 91 tone wheels. To get this sound, go to the TONEWL page, select 91 tone wheels, and set lowest pitch to C 1. Start with the **Junky** Wheel Volume Map and **Bob's** Organ Map. You may also want to increase the Key Click level, since this tends to become louder on older organs.

Middle Period Organs. To model one of these instruments, set 82 tone wheels and a low note of A 1. Use the **Mellow** Wheel Volume Map and **Eric's** Organ Map. Set Key Click to a moderate level.

The Classic B-3. For this sound, choose 79 tone wheels and set the low note to be C 2. The best settings here are the **Bright** Wheel Volume Map and **Peck's** Organ Map. You may also want to reduce the Key Click level.

KB3 Editor: Navigation

Navigation in the KB3 Editor is similar to navigation in the VAST Editor. Unlike the VAST Editor the KB3 editor does not have layers. See [Navigation on page 3-4](#) for details.

KB3 Editor: The Parameters (PARAMS) Page

The Parameters page in the KB3 Editor is similar to the Parameters page in the VAST Editor. See [The PARAMS Page on page 3-6](#) for details.

In the KB3 Editor, the Parameters page contains some parameters which do not appear on any other page: Rotary Slow/Fast, Rotary Brake, Chorus/Vibrato On/Off, Chorus/Vibrato Select, and Chorus/Vibrato Depth.

KB3 Editor: The Program FX (FX) Page

This page is the same as the VAST Program editor FX page (see [The FX Page on page 3-13](#)).

KB3 Editor: The COMMON Page

The Common page in the KB3 Editor is similar to the Common page in the VAST Editor. See [The COMMON Page on page 3-17](#) for details.

In the KB3 Editor, the Common Page contains common organ emulation parameters (in addition to the VAST Editor Common Page parameters).

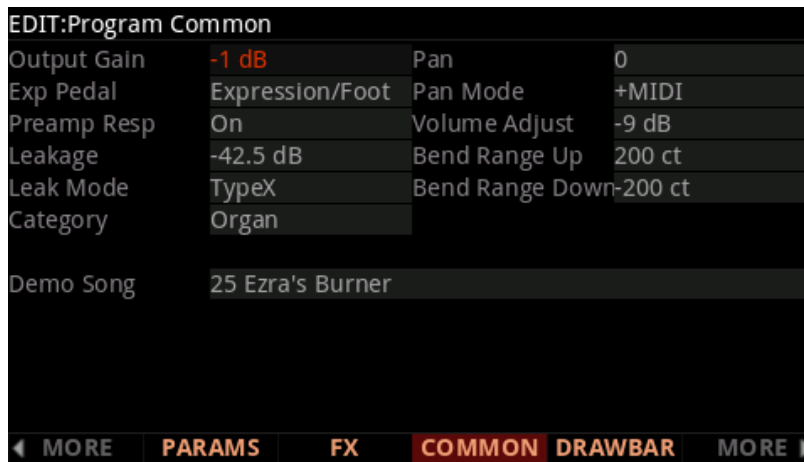

Preamp Resp

Set this parameter On or Off to enable or disable the preamp+expression pedal part of the KB3 program. Turning this **On** (the default) makes KB3 programs function like stock organs. The expression pedal in this case is more than a volume pedal; it actually functions like a “loudness control,” varying the frequency response to compensate for the ear’s sensitivity at different volumes. In addition, the preamp provides a de-emphasis curve to compensate for the built-in tone wheel volume pre-emphasis. Turning preamp response **Off** emulates organs that have been modified to have a direct out (before the preamp and expression pedal). Set Preamp Resp to Off to disable the volume pedal.

Exp Pedal

Use this parameter to set which rear panel CC Pedal input will control volume for the current KB3 program. With a setting of **Expression/Foot**, volume can be controlled by a CC pedal plugged into either the rear panel input labeled CC Pedal 1 (volume), or the rear panel input labeled CC Pedal 2. With a setting of **Expression**, volume can be controlled by a CC pedal plugged into the rear panel input labeled CC Pedal 1 (volume). With a setting of **Foot**, volume can be controlled by a CC pedal plugged into the rear panel input labeled CC Pedal 2. With a setting of **None**, volume control from both CC pedal inputs is disabled.

Leakage

This parameter controls the level of the simulated crosstalk and signal “bleed” of adjacent tone wheels in the model. This is provided to help “dirty up” the sound to make it a bit more realistic. A setting of -96 dB gives the purest tones; other values add more simulated leakage. This level is scaled by the drawbar levels, as well as the expression pedal level.

LeakMode

This parameter selects between different leakage models, determining which leakage harmonics are emphasized. **TypeA** provides an overall tone wheel leakage, with all tone wheels leaking a small amount. **TypeX**, **TypeY**, **TypeZ**, and **TypeR** emulate different degrees of drawbar leakage, where the leakage components correspond to the nine drawbars, instead of all the tone wheels.

VolAdjust

Use the VolAdjust parameter to adjust the pre-insert FX volume of the program. (Use the Output Gain parameter to adjust the overall post-FX volume of the program.)

Bend Range Up, Bend Range Down

Respectively control the upward and downward pitch bend ranges of the KB3 program.

KB3 Editor: The Drawbars (DRAWBAR) Page

Press the DRAWBAR soft button to view the Drawbars Page.

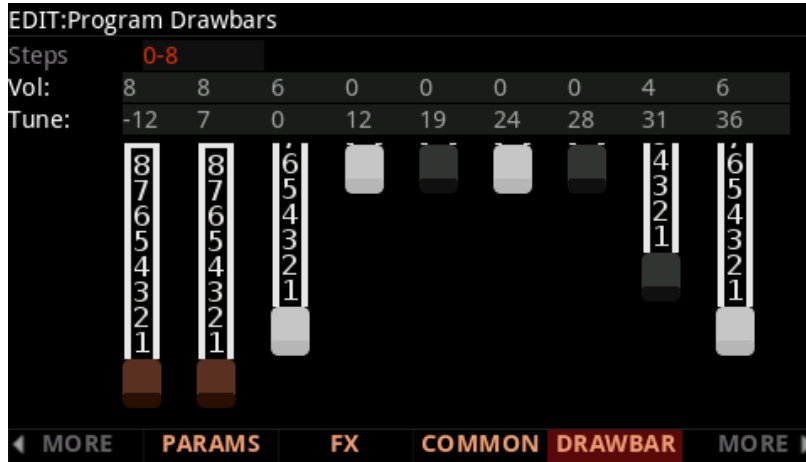

Steps

This parameter lets you specify the increments by which drawbar volumes will change. Choose either 0–8, to approximate the drawbar settings on actual organs, or choose 0–127 for a finer degree of resolution.

Volume

Use the Volume parameter to set the preset volume of each of the nine drawbars. The available values will be 0–8 or 0–127, depending on the setting of the Steps parameter.

Tune

This parameter lets you tune each of the nine drawbars up or down in semitone steps. The values for the Tune parameter on the Drawbars page shown above represent standard drawbar settings on a real B3, as shown in the table below.

Subharmonics		Fundamental	Harmonics					
16'	5 1/3'	8'	4'	2 2/3'	2'	1 3/5'	1 1/3'	1'
Slider 1	Slider 2	Slider 3	Slider 4	Slider 5	Slider 6	Slider 7	Slider 8	Slider 9

KB3 Editor: The Tone Wheels (TONEWL) Page

KB3 programs use DSP-generated waveforms for the lower half of the tone wheels, and samples for the upper half of the tone wheels. Using the parameters on the TONEWL page, you can specify which samples you wish to use, the number of tone wheels (which affects how many VAST voices are available), and other related settings.

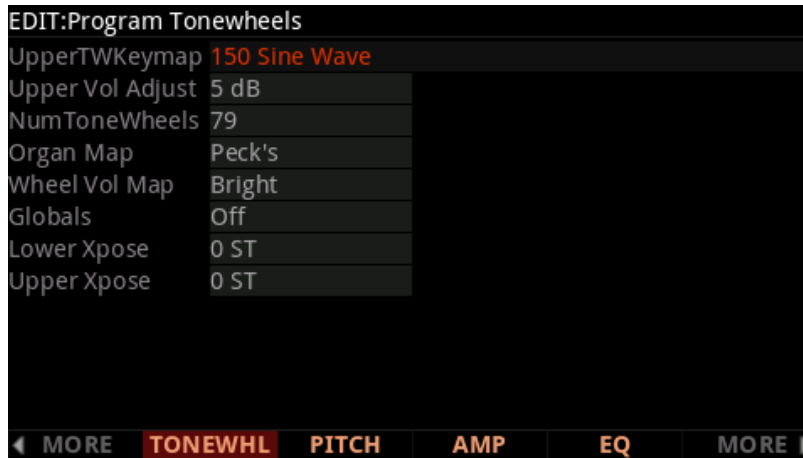

UpperTWKeymap (Upper Tone Wheel Keymap)

Use this parameter to indicate the keymap (and thereby the samples) to use for the upper tone wheels. You can use any keymap from ROM, though you must specify a keymap that uses looped samples for KB3 programs to work correctly.

Upper Vol Adjust (Upper Volume Adjust)

This parameter lets you adjust the amplitude of the upper tone wheels relative to amplitude of the lower tone wheels.

NumToneWheels (Number of Tone Wheels)

This parameter lets you specify the number of tone wheels used by a KB3 program. The classic tone wheel organs used 91 tone wheels, though the lowest 12 were for the pedals only. Therefore, you may find 79 a good number of tone wheels to specify for realistic organ emulations. You can specify up to 91 tone wheels.

The number of PC4 voices used by a KB3 program is typically half the number of tone wheels selected (in some cases 1 more voice may be used). For example, 79 tone wheels would use 40 of the PC4's 256 voices. This would leave you 216 voices for other programs. Keep in mind that these voices are permanently allocated and running while the KB3 program is selected, and cannot be stolen.

Organ Map

The organ map controls the relative amplitude of each key, per drawbar. Like the wheel volume maps, these maps are based on measurements we've made on actual organs. **Equal** uses the same volume for each key and drawbar, and is not based on a real B3. **Peck's** is a good normal map, from a B3 in good condition. **Eric's** is a bit more idealized; it's smoothed out, but less realistic. **Bob's** is more uneven, based on an old B3.

Wheel Vol Map (Wheel Volume Map)

The wheel volume map determines the volume level for each tone wheel. We've provided several tone wheel volume maps here, based on measurements we've taken on different organs. **Equal** is a map with all tone wheels at the same volume. It's not based on a real B3. **Bright** is a good normal map, based on a B3 in good condition. **Junky** is based on a B3 with an uneven, rolled-off response. **Mellow** is somewhere between Bright and Junky.

You can also apply EQ to control wheel volumes based on the frequencies of each tone wheel. See [KB3 Editor: The EQ Page on page 3-115](#).

Globals

The Globals parameter affects LFO2, ASR2, and FUNs 2 and 4. When Globals is set to Off, these four control sources are local; they affect each pair of tone wheels individually. They begin operating each time a tone wheel is turned on. When Globals is set to On, these control sources become global, and they affect every tone wheel of the current program simultaneously. Since all tone wheels are turned on nearly simultaneously when a program is selected, you typically will not notice a difference between having Globals set to On or Off. In some cases, it may be possible to hear differences in the modulation of each pair of tone wheels when using these control sources with Globals set to Off.

Lower/Upper Xpose (Lower/Upper Transpose)

These two parameters let you transpose the upper and/or lower tone wheels in semitone steps away from their default tunings.

Program Edit Mode

KB3 Editor: The PITCH Page

KB3 Editor: The PITCH Page

The PITCH page parameters for KB3 programs are similar to the Pitch parameters for VAST programs on the DSP MOD page. (In KB3 programs, there are no Hz, KeyTrk, or VelTrk parameters.) Use the **Coarse** and **Fine** parameters to transpose the entire program up or down in semitones or cents. The parameters in the right column can be used to modulate the pitch, and work the same as the “Pitch” modulation parameters in VAST programs. For a full description of these modulation source and depth parameters, see [“Subpage Parameters” on page 3-57](#).

EDIT:Program Pitch			
Coarse	0 ST	Source 1	OFF
Fine	0 ct	Depth	0 ct
		Source 2	OFF
		Depth Control	OFF
		Min Depth	0 ct
		Max Depth	0 ct

KB3 Editor: The AMP Page

The AMP page parameters for KB3 programs are similar to the Level parameters for VAST programs on the DSP MOD page. (In KB3 programs, there are no KeyTrk or VelTrk parameters.) Use the **Coarse** parameter to adjust the program’s pre-FX volume level up or down in dB. The parameters in the right column can be used to modulate the volume level, and work the same as the volume “Level” modulation parameters in VAST programs. For a full description of these modulation source and depth parameters, see [“Subpage Parameters” on page 3-57](#).

EDIT:Program Amp			
Coarse	-5 dB	Source 1	OFF
		Depth	0 dB
		Source 2	OFF
		Depth Control	OFF
		Min Depth	0 dB
		Max Depth	0 dB

KB3 Editor: The EQ Page

The four column headers on this page represent two shelving bands of equalization and two parametric bands. The KB3 EQ offered here, though, is not implemented as a true EQ section; instead, it adjusts the volume of the tone wheels based on frequency. If the tone wheels are based on sine waves, then this acts similarly to a real EQ.

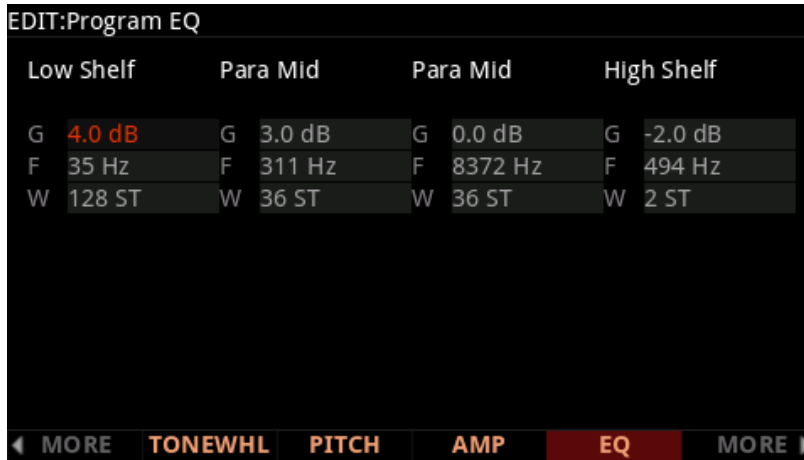

Each EQ section has **Gain (G)**, **Frequency (F)**, and **Width (W)** controls. **Frequency** controls the center frequency of the band. **Width** controls the bandwidth. **Gain** controls the amount of boost or cut.

KB3 Editor: The PERC Page

Percussion is a characteristic feature of tone wheel organs. It's especially useful while soloing, since percussion adds an extra "plink" (actually an extra tone at a defined harmonic) to the attack. You can reach the percussion parameters by pressing the PERC soft button.

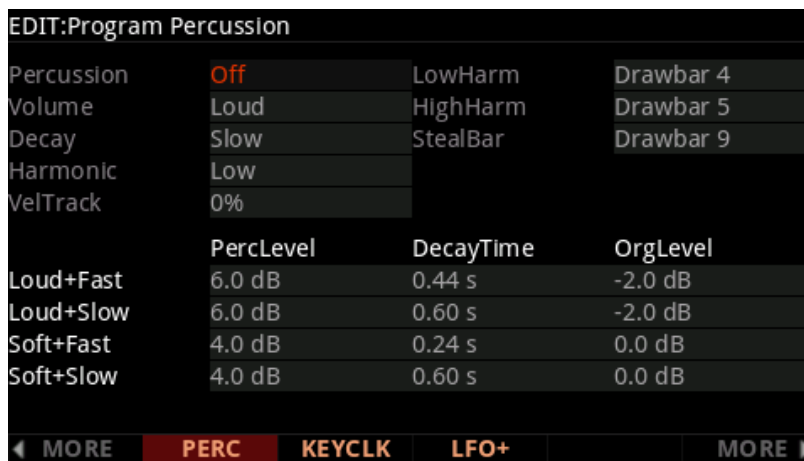

Percussion

Use this parameter to turn the percussion effect on or off. Percussion is created by a decaying envelope applied to one of the nine drawbars. The percussion effect is “single-triggered,” which means that once it’s triggered, it won’t trigger again until all keys (or whatever you’re using to trigger notes) go up. So if no keys are down, and you play a chord, percussion gets applied to all notes in the chord (and in fact, to all notes that are triggered during the short duration of the percussion envelope). Once the envelope runs its course, any notes you play while at least one key is held down get no percussion. You can turn percussion on or off by pressing Assignable Switch button 5 (labeled [Percussion] On/Off).

Volume

This parameter switches between loud and soft percussion settings. (Specific loud/soft amplitudes are set with the PercLevel parameters.) You can toggle between loud and soft by pressing Assignable Switch button 6 (labeled [Percussion] Loud/Soft).

Decay

This parameter switches between fast and slow percussion settings. (Specific fast/slow times are set with the DecayTime parameters.) You can toggle between slow and fast decay by pressing Assignable Switch 7 button (labeled [Percussion] Decay F/S).

Harmonic

This parameter switches between high and low harmonic percussion settings. (Specific high/low pitches are set with the LowHarm and HighHarm parameters.) You can toggle between low and high harmonics by pressing Assignable Switch button 8 (labeled [Percussion] Pitch H/L).

VelTrack

This parameter specifies the degree to which key velocity controls percussion volume. A value of zero corresponds to no velocity tracking, which is like a real tone wheel organ. Other values add velocity tracking, so that increased velocity results in louder percussion. This parameter typically only applies when playing a KB3 program from an external MIDI device.

LowHarm

This parameter controls which drawbar is used as the basis for the percussion when Harmonic is set to **Low**. On an actual tone wheel organ, this is Drawbar 4 (2nd harmonic). The actual pitch obtained depends on the drawbar tuning.

HighHarm

This parameter controls which drawbar is used as the basis for the percussion when Harmonic is set to High. On an actual tone wheel organ, this is Drawbar 5 (3rd harmonic). The actual pitch obtained depends on the drawbar tuning.

StealBar

This parameter controls which drawbar is disabled when the percussion effect is turned on. On an unmodified tone wheel organ, the ninth drawbar is the one disabled. Any drawbar can be selected.

PercLevel, DecayTime, OrgLevel

With these parameters you can control the amplitude and decay time of the percussion effect for all combinations of the PERC page Volume and Decay parameter settings. You can also adjust the level of the organ relative to the percussion, for accurate emulation of classic organs.

KB3 Editor: The KEYCLICK Page

The Key Click feature adds a decaying burst of pitched noise to the attack of notes. Unlike the percussion feature, key click is “multi-triggered,” which means that every new note will trigger it. The parameters on this page primarily control the decay, volume, and pitch of the key click.

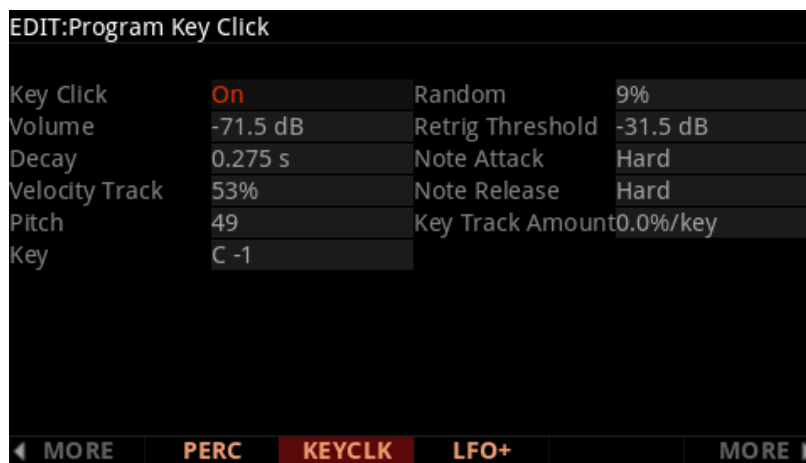

Key Click

Use this parameter to turn Key Click on or off. With Key Click set to Off, you may still hear a click depending on your Note Attack and Note Release settings (see below).

Volume

This parameter sets the level of the keyclick; the noise decays from the level you set here. This level is scaled by the drawbar levels, as well as the expression pedal level.

Decay

This parameter sets the basic decay time of the noise envelope. Smaller values produce a shorter burst.

Velocity Track

This parameter controls the degree to which key velocity affects the key click volume. A value of zero means that the key velocity has no effect on the key click volume (which is like a real tone wheel organ). Other values add volume as the velocity increases. This parameter typically only applies when playing a KB3 program from an external MIDI device.

Pitch

This parameter sets the basic pitch of the key click noise, relative to the highest tone wheel's pitch. The pitch is controlled by a steep lowpass filter applied to white noise. The filter's cut off frequency is controlled relative to key number, higher keys move the cutoff frequency up, lower keys move the cutoff frequency down.

Random

This parameter controls the degree to which a random amount of amplitude variation is added to the key click.

Retrig Threshold

This parameter lets you set the volume level below which key click must decay before it will be retriggered.

Note Attack

This parameter controls the attack characteristic of notes. **Normal** provides a smoothed attack, while a setting of **Hard** has an instant attack and will produce an audible click, in addition to any amount of key click specified with the other parameters on this page (you might prefer not to specify any additional key click when you use this setting). **PercHard** sets a hard attack level for percussion only; notes without percussion use a normal attack.

Note Release

This parameter controls the release characteristic of notes. A setting of **Normal** has a smoothed release, while a setting of **Hard** has an instant release. Hard will produce an audible click.

Key and Key Track Amount

Key Track Amount can be used to scale the key click volume, so that lower notes will have a quieter key click. The **Key** parameter determines the key at which the volume scaling will begin. (When the Key parameter is selected, you can select the desired key by holding the ENTER button and striking a key.)

The selected key will use the key click volume set by the **Volume** parameter. Each key below the selected key will have progressively quieter key click. For example, with Key Track Amount set to -5.0%/key, the note 1 key below the selected Key will have its keyclick volume lowered by 5%, the note 2 keys below the selected Key will have its key click Volume lowered by 10%, and so forth.

KB3 Editor: The LFO+, ARP and CC SEQ Pages

These pages are the same for KB3 programs as they are for VAST programs. For descriptions of these pages see:

[The LFO+ Page on page 3-67](#)

[The Arpeggiator \(ARP\) Page on page 3-22](#)

[The CC Sequencer \(CC SEQ\) Page on page 3-35](#)

Chapter 4

The Effects Chain Editor

When in Program Edit Mode on the FX page, pressing the EDIT button while a Chain (other than 0 None) is highlighted—on any of the various effects pages—will call up the Chain editor.

You may edit Effects Chains containing up to 16 effects boxes using up to 32 DSP units. Choose from 18 types of effects boxes, including hundreds of effects box algorithms and presets. Create custom controller assignments and apply modulation with LFOs, ASRs and mathematical functions.

From the Program editor, the program's Insert and Aux Chains can be edited from the FX and LYR FX pages. In Multi Edit Mode, Chains selected for Aux overrides can be edited from the FX page.

A Chain is made up of one or more effect-boxes, with each box containing a single effect. You can have up to 16 effect-boxes in a Chain. The settings for all of the parameters of each effect-box are also stored within the Chain. There are 30 Mod Controls that allow for real-time control over any parameter from any effect-box in the Chain. Per Chain Control sources are also provided to be used as inputs to the effect Mods (two FXLFOs, two FXASRs, and four FXFUNs). These work similarly to the LFOs, ASRs and FUNs in Program mode, but are only available for use with the effect Mods.

The Effects Chain Editor

The MAIN Page

The MAIN Page

In the Chain Editor, pressing the MAIN soft button calls up the MAIN page. This is where you configure the length of a Chain and select the individual effects that make up the Chain.

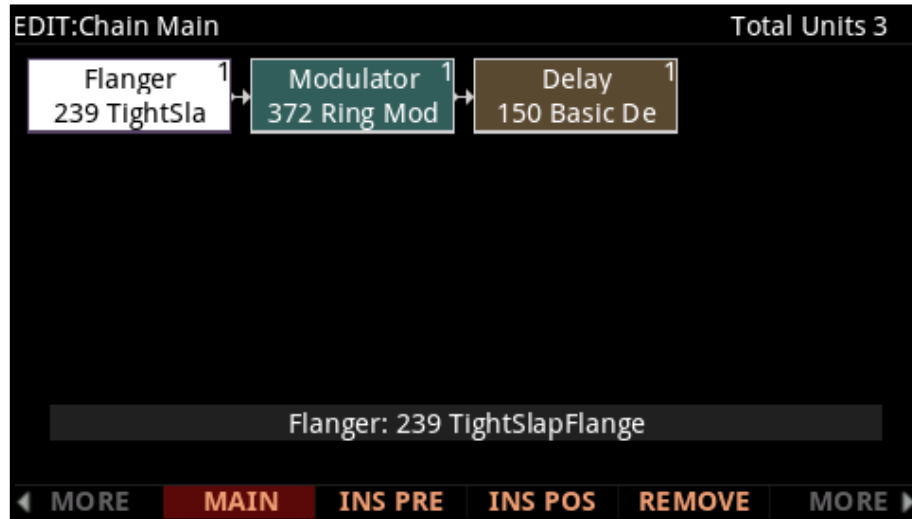

At the top right of the display is the number of DSP units used by the currently selected effect- box, and by the Chain as a whole. There are a total of 32 units available for all of the Chains that are currently loaded by programs and any active Aux overrides from Multi Mode.



Note: In some configurations, not all 32 units are available for use with multi-unit effects because of the way the DSP is allocated internally.

Like all other representations of signal paths in the PC4 display, the program signal moves from left to right through the Chain. Use the cursor buttons to select an effect-box or empty spot in the Chain. The effect loaded into the selected effect-box can be changed by numeric entry, with the Alpha Wheel, or with the +/- buttons; and can be changed with either the effect-box or the Effect field at the bottom of the page highlighted. The +/- double button press will jump to the next effect “category.”

Pressing the INSPRE soft button adds a new effect-box to the Chain in the currently selected block-slot, and pushes the currently selected effect-box down the Chain to the right. (If you have run out of DSP units, you will not be able to create additional effects boxes.) Pressing the REMOVE soft button takes the currently selected effect out of the Chain.

Editing Effect-boxes

To edit the parameters of an effect, select its effect-box on the MAIN page and press the EDIT button. For each effect, there are one or more pages of parameters that are specific to that effect. See [Effects Parameters on page 4-9](#) for details on parameters for each type of effect. Any parameter controlled by an effect Mod will display a value of FxMod and cannot be edited. To return to the MAIN page of the chain editor, press the Exit button.

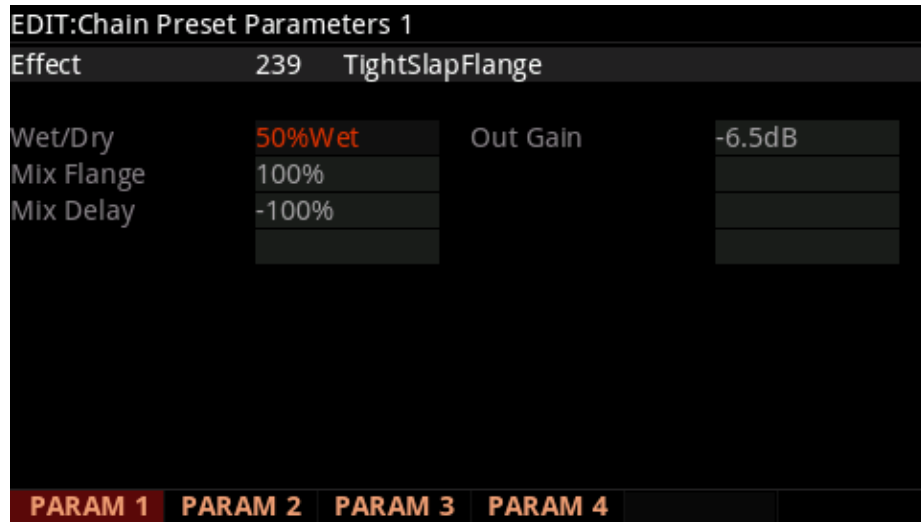

The MOD Pages

There are three pages for configuring effects mods: MOD1 - MOD3. All pages are essentially identical in appearance and function. See below for an example MOD page:

EDIT:Chain MODs 1				
Box:	Param:	Adjust:	Source:	Depth:
Box3	Wet/Dry	13%Wet	FXFUN1	55%Wet
Box1	Out Gain	-6.5dB	FXFUN2	0dB
None			OFF	
None			FXFUN3	
None			FXFUN3	
None			OFF	
None			OFF	
None			OFF	
None			OFF	
None			OFF	

< MORE MOD1 MOD2 MOD3 FXLFO+ MORE >

Box

The Box parameter specifies which effect-box in the Chain to which the Mod will be applied.

Param

Use the Param field to select an FX box parameter to modulate.

Adjust

Use the Adjust field to set a fixed value for the specified parameter. When the Control source has a value of 0, the modulated parameter will be set to the Adjust value.

Source

The Source parameter determines the Control source that will modulate the parameter (Param) value in real-time.

When the Source field is selected, you can quickly assign one of the PC4's physical controllers (sliders, mod wheel, pedals, etc.) by holding the **Enter** button and moving the desired controller. The MIDI CC number associated with that controller will be selected. You can also enter a CC number for external MIDI control, or select one of the Chain-specific Control sources (FXLFOs, FXASRs, and FXFUNs).

When a MIDI CC number is selected for the Source field, a Chain info entry will be created on the INFO page (unless that CC number is already used by another FX Mod). See the [INFO page](#) section below for details.

If you have selected a MIDI CC number or PC4 physical controller, the FX Mod will appear on the program Parameters page (unless that CC number is already used by another FX Mod, in which case it will share the existing Parameter using that CC number or physical controller). The program Parameters page allows you to set a default value for the FX Mod, and also lets you select a different MIDI CC number or PC4 physical controller if desired. This is useful for changing the control source of existing FX Mods without editing the chain.

Note: In some cases when entering a MIDI CC number, the source field will show the standard MIDI name associated with that MIDI CC number.

Some MIDI CCs are hard wired to control certain program parameters or functions such as MIDI 5 (Portamento Time), MIDI 7 (Program Volume), MIDI 10 (Pan), MIDI 11 (Expression/Program Volume), MIDI 64 (Sustain), MIDI 66 (Sostenuto), so if you use one of these numbers the CC will always perform the hard wired function, in addition to any other assignment you make.

In Program Mode the PC4's physical controllers each use one of the available MIDI CC numbers, so you must choose one of the other available CC numbers when using an external MIDI control source or else the parameter will also be controlled by a PC4 physical controller. MIDI CC numbers associated with the PC4's physical controllers are shown in the list below.

PC4 Physical Controller MIDI CC Numbers

Mod Wheel (MIDI CC 1)	Slider 4 (MIDI CC 23)	Knob 3 (MIDI CC 72)
Knob 8 (MIDI CC 3)	Slider 5 (MIDI CC 24)	Knob 2 (MIDI CC 73)
CC Pedal 2 (MIDI CC 4)	Slider 6 (MIDI CC 25)	Knob 4 (MIDI CC 79)
Knob 9 (MIDI CC 9)	Slider 7 (MIDI CC 26)	Switch 1 (MIDI CC 80)
CC Pedal 1 (MIDI CC 11)	Slider 8 (MIDI CC 27)	Switch 2 (MIDI CC 81)
Slider 1 (MIDI CC 12)	Slider 9 (MIDI CC 28)	Switch 3 (MIDI CC 82)
Slider 2 (MIDI CC 13)	Variation Button (MIDI CC 29)	Switch 4 (MIDI CC 83)
Knob 5 (MIDI CC 14)	Sw. Pedal 1a (MIDI CC 64)	Switch 5 (MIDI CC 85)
Knob 6 (MIDI CC 17)	Sw. Pedal 1b (MIDI CC 66)	Switch 6 (MIDI CC 86)
Knob 7 (MIDI CC 18)	Sw. Pedal 2a (MIDI CC 66)	Switch 7 (MIDI CC 87)
Ribbon Section 1 (MIDI CC 21)	Sw. Pedal 2b (MIDI CC 67)	Switch 8 (MIDI CC 89)
Slider 3 (MIDI CC 22)	Knob 1 (MIDI CC 71)	Switch 9 (MIDI CC 90)

Depth

The Depth field determines the range of modulation that the Controller will apply. When the Control source has a value of 0, the modulated parameter will be set to the Adjust value. When the control source is all the way up, the modulated parameter will be set to the Adjust value plus the Depth value.

FXLFO+ page

This is where you can edit the Effects-only Control sources. These are Control sources that can be used by the effects Mods in the current Chain. The parameters on these pages work exactly like those of the corresponding Control sources in Program Edit mode (see [The LFO+ Page on page 3-67](#)).

EDIT:Chain LFO/ASR/FUN						
	MnRate	MxRate	RateCt	Shape	Phase	
FXLFO1	0.00H	0.45H	Express	3/4 +Sine	0deg	
FXLFO2	0.00H	0.00H	OFF	None	0deg	
	Trigger		Mode	Delay	Attack	Release
FXASR1	OFF		Norm	0s	0s	0s
FXASR2	OFF		Norm	0s	0s	0s
	Input a		Input b		Function	
FXFUN1	MIDI89		MIDI27		a*b	
FXFUN2	MIDI87		MIDI26		a*b	
FXFUN3	MIDI86		MIDI25		a*b	
FXFUN4	OFF		OFF		None	
◀ MORE MAIN INS PRE INS POS REMOVE MORE ▶						

INFO page

Press the INFO soft button to go to the Chain Info page where you can edit the controller assignment info for the current Chain. Chain Info allows you to add a description for each FX Mod you have assigned. On the Chain Info page, use the CHANNEL/LAYER/ZONE/TRACK buttons to scroll through the current Chain's list of controller assignment info. Each assignment Info entry has a MIDI controller number and a Text parameter to describe what the assignment controls. One Info entry can be made for each MIDI CC number.

Chain Info allows you to see a name for each FX Mod controller assignment, as well as set an initial controller value for each FX Mod in each Program. When assigning a physical controller or CC number to a source field on one of the FX Mod pages, a Chain Info entry is automatically added to the Chain Info Page with the name of the FX parameter. Chain Info entries are also automatically deleted when their associated FX Mods are removed or unassigned from the FX Mod pages.

When an FX Chain is selected in a Program, the Chain Info entries appear on the Program Parameters page. Chain Info names are also shown on the main Program and Multi Mode Pages when moving an assigned controller. The Program Parameters page allows you to remap existing Chain FX Mod controller assignments, as well as set an initial MIDI value for each assignment. This allows you to reuse the same Chain in several Programs, and each of the Chain FX Mods can have a different controller assignment or initial value in each Program.

Each MIDI CC number can have one Chain Info entry. When setting an FX Mod source field, if the selected physical controller or CC number is already used by a different FX Mod in the Chain, a new Chain Info entry will not be added to the Chain Info Page. The new FX Mod will share the existing Chain Info entry for the same physical controller/MIDI CC. The name of the previously existing Chain Info entry will not change based on the new FX Mod. If you have assigned one physical controller/MIDI CC to multiple FX Mods, you may wish to edit the Info name to reflect this.

To edit a Chain Info name, first go to the Chain Info page, then use the CHANNEL/LAYER/ZONE/TRACK buttons to select the Info entry from the list. Press the Text soft button to enter the text editor for the currently selected Info entry. After making text changes, press the OK soft button, or press the cancel soft button to exit the text editor without making changes. Be sure to save the Chain when exiting the Chain editor in order to save your changes.

In some cases it may be desirable to manually create a new Chain Info entry. Press the New soft button, then choose an available MIDI CC. Once the Info entry is created, you can change its name using the Text soft button.

You can delete a Chain Info entry by selecting it on the Chain Info page and pressing the Delete soft button.

The Chain Utility Soft Buttons

Some of the soft buttons in the Chain Editor perform a function when pressed, as well as some of the Mode buttons.

INFO

On this page you can use the TEXT soft button to access a text editor to change a chain label.

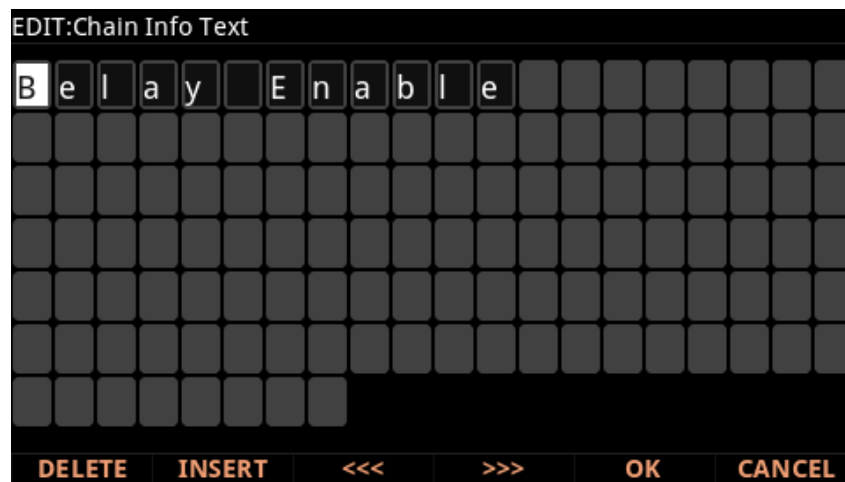
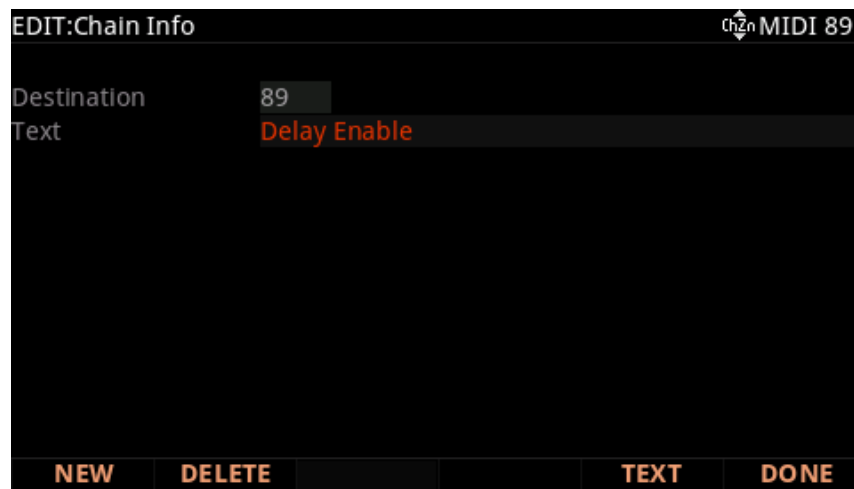

The Effects Chain Editor

The Chain Utility Soft Buttons

DELETE

Press the Delete soft button to delete the current Chain (factory Chains can not be deleted).

HELP

Press the HELP soft button to view the Help page, where you can view a description of functions assigned to the Mode buttons.

Global Mode Button: Bypass Box

Press the Global Mode button to temporarily bypass the currently selected FX box in the Chain. Press the Global Mode button again to re-enable the selected box.

Effects Parameters

This section contains descriptions of the PC4's many effects parameters, and instructions on how to use them. Read through this section to get a good general understanding of the parameters.

The descriptions here do not include all of the parameters associated with every effect, and some effects may not have some of the parameters described here for their category. A more complete reference, with every effect and the meaning and range of every parameter, arranged in the order they appear on the screen, can be found in the KSP8 Algorithm Reference Guide on the Kurzweil website, www.kurzweil.com.

General Parameters

There are a number of parameters that are common to all or almost all effects, and we'll deal with those first.

Wet/Dry balances the levels of the processed and unprocessed signals output from the effect. Wet represents the processed signal, while dry represents the unprocessed signal. The range is 0% wet (the signal is unprocessed) through 100% wet (no dry signal is present). Values between 0% and 100% blend the two signals, for example, at 20% the output signal is 20% wet (processed) and 80% dry (unprocessed.) A setting of 50% wet means the dry and processed signals are roughly equal in level. In some effects, separate Wet/Dry parameters are provided for the Left and Right input channels. In some cases, this parameters can have negative values, which indicate that the Wet signal is polarity-inverted.

When an effect with the Wet/Dry parameter is used in Chain that has been selected as an Aux effect, Wet/Dry is automatically set to 100% wet and cannot be adjusted. This is because when using an Aux effect, the dry signal is already effectively at 100% on the main audio bus (not routed through the Aux effect.) In this case, turning up the Aux send level will blend the 100% wet signal (from the Aux bus) with the dry signal on the main audio bus.

Out Gain sets the gain at the output of an effect.

In/Out enables or disables the effect. You can think of it as a Wet/Dry parameter with only two

HF Damping (high frequency damping) is the cutoff (-3 dB) frequency of a 6dB/octave lowpass filter that's inserted before the processor. High frequencies above the set cutoff frequency will be filtered out. In the case of processors where multiple iterations of the signal are heard, such as in a delay, each iteration of the signal will pass through the filter, and will therefore be duller.

The Effects Chain Editor

Effects Parameters

XCouple (Cross Couple). In stereo effects, this controls how much of any signal being fed back is going to the channel opposite to the one where it first appeared. At 100%, all feedback from signals at the left input goes to the right channel and vice versa, causing a “spreading” or in the case of delay lines, a “ping-pong” effect. At 0%, fed-back signals stay with the channel they came in on.

A->B cfg (configuration). In combination effects that contain two (or more) components, the order in which the signal passes through the two components can be changed with this parameter. Combination effects are usually named with a “->”, as in 484 “Flange->Shaper.” For example, 484 “Flange->Shaper” can be configured so the signal passes through the flanger first and then the shaper, or through the shaper first and then the flanger. The *cfg* parameter determines the configuration, and its value is context-sensitive—in this example, the choices would be “Fl->Shp” and “Shp->Fl.”

A/Dry->B is also found in many combination effects, and controls the amount of signal that will pass dry (unprocessed) through the first component into the second component. Different combination effects use different variations on this parameter, depending on the context. The range is 0 to 100%.

Reverbs

Room Type changes the configuration of the effect to simulate a wide array of room types and sizes including booths, small rooms, chambers, halls and large spaces. Because this parameter changes the structure of the reverb effect, you need to be careful when assigning it a MOD—changing it in real time while signal is passing through it is likely to cause audible artifacts. Room types in different effects with similar names do not necessarily sound the same.

Rvrb Time is the RT60—the time it takes for the reverb to decay to 60 dB below its initial level—in seconds. It is accurate assuming that several other parameters (HF Damping, Diff Scale, Size Scale, and Density) are at their nominal levels. It is adjustable up to “Inf”, which creates an infinitely-sustaining reverb.

LateRvbTim adjusts the basic decay time of the late portion of the reverb after diffusion.

L Pre Dly and R Pre Dly (Pre-Delay) is the time between the start of a sound and the output of the first reverb reflections from that sound. Longer pre-delays can help make larger spaces sound more realistic. Longer times can also help improve the clarity of a mix by separating the reverb signal from the dry signal, so the dry signal is not obscured. You can set a separate time for the left and right reverb signals using L Pre Dly and R Pre Dly.

EarRef Lvl adjusts the mix level of the early-reflection portion of effects which offer early reflections.

Late Lvl adjusts the mix level of the late-reverb portion of effects which offer early reflections.

Diff Scale scales the “diffusion“ of the early reflections, that is, how spread out they are as a group over time. At very low settings, the early reflections start to sound quite discrete, and at higher settings the early reflections are seamless. It is adjustable from 0.00 to 2.00, with 1.00 being nominal for the given Room Type.

Density controls how tightly the early reflections are packed in time. Low Density settings group the early reflections close together, while higher values spread the reflections for a smoother reverb. It is adjustable from 0.00 to 4.00, with 1.00 being nominal (and usually optimal) for the given Room Type.

Expanse controls the amount of late reverb energy biased toward the edges of the stereo image. A setting of 0% will bias energy towards the center. Moving away from 0% will bias energy towards the sides. Positive and negative values will have a different character.

Build adjusts the envelope of certain portions of the reverb. Positive values speed up the envelope, and negative values slow it down.

Size Scale changes the size of the current room. Altering this parameter will change the reverb time and also cause some coloration of the reverb. It is adjustable from 0.00 to 4.00, with 1.00 being nominal (and usually optimal) for the given Room Type.

InfinDecay, when turned “On”, causes the reverb tail to decay infinitely. When it’s “Off”, the decay time is determined by the “Rvrb Time” or “LateRvbTim” parameters. This is a good parameter to control with a footswitch.

Wet Bal (Wet Balance). Some reverb effects are actually two stereo reverbs in one, with each one receiving a different mono signal. This balances the outputs of the two reverbs—0% means they are being mixed equally.

Delays

There are two types of taps in the Multitap delays: The “Loop” tap, which has a feedback loop back to its input, and the numbered taps. The numbered taps can be single iterations or they can repeat as part of a loop, but they do not have individual feedback paths.

Fdbk (Feedback) Level controls the repeating function of the Loop Tap. A setting of 0% means there will only be a single delay, while a setting of 100% means the signal keeps repeating without ever stopping.

Both types of taps are individually adjustable from 0 to 2.55 seconds. The Loop Crs and Tapn Crs (**n** being the number of the tap) parameters set the coarse value of the loop in 20-ms increments, while the Loop Fine and Tapn Fine parameters set the fine value in 0.2-ms increments.

In Delay effects that use tempo to determine tap lengths, there is a Tempo parameter which can be set from 1 to 255 BPM or to “System,” which uses the global System Tempo. The Loop Length and Tapn Delays are then expressed in beats relative to that overall Tempo.

The Effects Chain Editor

Effects Parameters

Hold is a switch that, when turned on, “locks” any signal currently in the delay and plays it until Hold is turned off. When Hold is on, no signal can enter the delay and Feedback is set to 100%. A good parameter to control with a footswitch.

Dry Bal (Balance) is the left/right balance of the dry signal. At -100%, only the left dry signal goes to the left output, while at 100% only the right dry signal passes to the right output, and at 0%, equal amounts of the left and right dry signals pass to their respective outputs.

Tapn Level is the level of each numbered tap, from 0% to 100%, relative to the overall output of the effect.

Tapn Bal is the left/right balance of each of the numbered taps. At -100%, only the left channel of tap n goes to the left output, while at 100% only the right channel of tap n goes to the right output. At 0%, equal amounts of the left and right channels of the tap pass to their respective outputs. In some delays, pairs of taps (1 and 5, 2 and 6, etc.) are controlled together as stereo pairs.

DelayScale lets you change the lengths of all the taps together. Its range is 0 to 10x.



Note: It is possible for the PC4 to run out of delay memory with large settings of DelayScale or very slow Tempos. Some Delay effects will simply go to a maximum value and stay there, while in some, a calculation is made that automatically cuts the delay times in half, thereby maintaining a relationship with tempo.

Complex Echo

This effect has two feedback taps per channel as well as three independent taps, and also a feedback diffuser for “smearing” the delays. Feedback line 1 feeds the signal back to the delay input of the same channel, while feedback line 2 feeds the signal back to the opposite channel.

FB2/FB1 > FB is a balance control between feedback lines 1 and 2. 0% (minimum) turns off feedback line 2, only allowing use of feedback line 1. 50% is an even mix of both lines, and 100% (maximum) turns off line 1.

L Diff Dly and **R Diff Dly** adjusts the delay lengths of the diffusers. Range is 0 to 100 ms. **Diff Amt** adjusts the diffuser intensity. Range is 0 to 100%.

C Fdbk n Dly adjusts the delay length of the C channel’s nth feedback tap, fed back to the C channel’s delay input. Range is 0 to 2600 ms.

Spectral Multitap Delays

These 4- and 6-tap delays have their feedback and output taps modified with shapers and filters. In the feedback path of each tap are a diffuser, hipass filter, lopass filter, and imager. Each delay tap has a shaper, comb filter, and balance and level controls.

Fdbk Image sets the amount that the stereo image is shifted each time it passes through the feedback line. Range is -100 to 100%.

Tap n Shapr adjusts the intensity of the shaper at each output tap. Range is 0.10 to 6.00 x.
Tap n Pitch adjusts the frequency of the comb filter at each output tap. Range is C-1 to C8, in semitones.

Tap n PtAmt adjusts the intensity of the comb filter at each output tap. Range is 0 to 100%.

Gated Ducking Delay

This runs the last thing you played through a looping delay, but only outputs the delay signal when you aren't playing. Gated Ducking Delay is great for that announcer sound, sound, sound, so popular in Monster Truck radio spots.

DegenRegen

This one's a big looping delay with lots of gain, distortion and filtering, and with a compressor to keep it all under control.

Equalizers (EQ)

The PC4 has both Graphic and Parametric EQ effects. Parametric EQ sections are also found on a number of combination effects.

The **Graphic** equalizer is available as stereo (linked parameters for left and right) or dual mono (independent controls for left and right). It has 10 bandpass filters per channel, each of whose gain is adjustable from -12 dB to +24 dB.

Like all graphic equalizers, the filter response is not perfectly flat when all gains are set to the same level (except at 0 dB), but rather has ripple from band to band. To minimize this ripple, it is best to center the overall settings around 0 dB.

The **Parametric** equalizer ("5-Band EQ") has two bands of shelving filters and three bands of true parametric EQ.

Treb Freq and **Bass Freq** set the center frequencies for the shelving filters. Both of these are adjustable over the full range of 16 to 25088 Hz, in increments of a semitone.

Treb Gain and **Bass Gain** control the amount of cut or boost above (Treb) or below (Bass) the center frequency. The range is -79 to +24 dB.

Midn Gain sets the cut or boost for the parametric band n, with a range of -79 to +24 dB. **Midn Freq** sets the center frequency for parametric band n, with a range of 16 to 25088 Hz, in increments of a semitone.

Midn Width set the bandwidth of the filter on band n, with a range of 0.01 to 5 octaves.

Enhancers

Enhancers modify the spectral content of the input signal by boosting existing spectral content, or stimulating new ones. Two and three-band versions are provided.

The Effects Chain Editor

Effects Parameters

Drive adjusts the input into each band. Increasing the drive will increase the effects. Range is -79.0 to 24.0 dB.

Xfer adjusts the intensity of the transfer curves. Range is -100 to 100%.

EQ Morpher

This effect uses two four-band bandpass filters, A and B, and moves between them. This can produce very convincing human vocal type sounds.

FreqScale offsets the filter frequencies for each set of filters. After setting the filter parameters (Freq, Gain, and Width), the FreqScale parameters will move each of the four filter frequencies together by the same relative pitch. Range is -8600 to 8600 cents.

Morph A>B. When set to 0% the “A” parameters are controlling the filters, and when set to 100%, the “B” parameters control the filters. Between 0 and 100%, the filters are at interpolated positions. When morphing from A to B settings, the A filter #1 will change to the B filter #1, A filter #2 moves to B filter #2, and so on. Range is 0 to 100%.

Compressors, Expanders, and Gates

A wide range of Compression and Expansion effects is available in the PC4. The various effects include different combinations of:

- Compressors with soft-knee characteristic—the compression action comes in gradually as the signal level approaches the threshold
- Compressors with hard-knee characteristic—the compression action comes in abruptly when the signal reaches the threshold
- Expanders
- Multiband compressors that break the signal up into three frequency bands and compress them all separately
- Sidechains or output EQs
- Reverbs and compressors in combination
- Gates
- Gated reverbs

All of the Compression effects use these parameters:

FdbkComprs (Feedback Compression) selects whether to use feed-forward (set this to “Out”) or feed-back (set this to “In”) compression. The feed-forward configuration uses the input signal as a side-chain source, which is useful when the compressor has to act really quickly. The feed-back configuration uses the compressor output as the side-chain source, which lends itself to more subtle, but not as quick-reacting, compression.

Atk (Attack) Time for the compressor is adjustable from 0.0 to 228.0 ms. **Rel** (Release) Time for the compressor is adjustable from 0 to 3000 ms.

SmoothTime smooths the output of the expander's envelope detector by putting a lowpass filter in the control signal path. Smoothing will affect the Attack or Release times only when this parameter is longer than one of the other times. The range is 0.0 to 228.0 ms.

Signal Dly (Delay) puts a small delay in the signal relative to the sidechain processing, so that the compressor (or gate) “knows” what the input signal is going to be before it has to act on it. This means the compression can kick in before an attack transient arrives. In the SoftKneeCompress and HardKneeCompress effects, delay is really only useful in feed-forward configuration (FdbkComprs is “Out”). For other compressors, the delay can be useful in feedback configuration (FdbkComprs is “In”). The range is 0 to 25 ms.

Ratio is the amount of gain reduction imposed on the compressed signal, adjustable from 1.0:1 (no reduction) to 100:1, and Inf:1.

Threshold is the level in dBFS (decibels relative to full scale) above which the signal begins to be compressed. Adjustable from -79.0 to 0 dB.

MakeUpGain allows additional output gain to compensate for gain reduction in the compressor. It is essentially the same parameter as Out Gain, with which it is summed. The minimum is -79.0, and the maximum summed gain (MakeUpGain + Out Gain) is +24.0 dB.

Expansion

Effects containing Expanders have these controls:

Atk or **Exp Atk** (Attack), how fast the expander turns off when the input signal rises above the threshold level, adjustable from 0.0 to 228.0 ms.

Rel or **Exp Rel** (Release), how fast the expander turns back on after the signal drops below the threshold level, adjustable from 0 to 3000 ms.

Ratio or **Exp Ratio**, how much the gain is reduced below the expansion threshold, adjustable from 1:1.0 (no expansion) to 1:17 (extreme downward expansion).

Threshold or **Exp Threshold**, the level below which the signal is expanded, adjustable from -79.0 to 0 dB.

In addition, the two-segment compressors with expander have separate Ratio and Threshold controls for each of the compression segments.

Multiband Compression

The Multiband Compression effect has Attack, Release, Smooth, Signal Delay, Ratio, Threshold, and MakeUp Gain parameters for each of the three bands (“Low”, “Mid”, and “High”). In addition, it has:

Crossover1 and Crossover2. These set the frequencies which divide the three compression frequency bands. The two parameters are interchangeable, so either may contain the higher frequency value. The range is 16 to 25088 Hz, in increments of a semitone.

The Effects Chain Editor

Effects Parameters

Gates

SC Input lets you select which input channel(s) will control the sidechain, which is responsible for opening and closing the gate. It can be set to L, R, or the average of the two channels, (L+R)/2. You can use this, if you arrange the signal paths and pan controls appropriately, to gate one mono signal with a different mono signal.

Gate Time is the time that the gate will stay open after the sidechain signal reaches the Threshold. Its range is 0 to 3000ms.

Ducking reverses the action of the gate. Normally this is set to “Off”, and the gate opens when the input signal rises above the threshold. But when this is “On”, the gate closes when the input signal rises above the threshold.

Super Gate

Super Gate is a more sophisticated gate that includes these two functions:

Env Time is the amount of time it takes for the sidechain signal envelope to drop below the threshold. If this time is too short, the gate can close and open too quickly from amplitude modulation in the sidechain signal. If it is too long, the gate may stay closed until the envelope has a chance to fall, and some signals would not get through. This parameter is only in effect when Retrigger is Off.

Retrigger determines whether the gate timer will reset itself each time the sidechain signal goes above the threshold. If it is “On”, the timer resets itself, and therefore the gate stays open as long as the signal is above the threshold, or keeps going above the threshold, within the interval specified by Gate Time. If it is “Off”, the gate closes down after Env Time has elapsed, regardless of the sidechain level, and the sidechain level must fall below the threshold and come back up again before the gate will open again.

Chorus

Chorus is an effect which gives the illusion of multiple voices playing in unison. The effect is achieved by detuning copies of the original signal and summing the detuned copies back with the original. Low frequency oscillators (LFOs) are used to modulate the positions of output taps from a delay line. The movement of the taps causes the pitch of the signal to shift up and down, producing the required detuning.

The choruses are available as stereo or dual mono. The stereo choruses have the parameters for the left and right channels ganged, while the dual mono choruses have separate left and right controls.

Fdbk Level is the level of the feedback signal from the LFO1 delay tap into the delay line. Negative values polarity-invert the feedback signal.

Tap Lvl sets the levels of the LFO-modulated delay taps. Negative values polarity-invert the signal. Setting any tap level to 0% turns it off.

Tap Pan sets the stereo position for a given tap's output. The range is -100% for fully left, to 100% for fully right.

Atk Time (attack time) is the time for the gate to ramp from closed to open (reverse if Ducking is on) after the signal rises above threshold, adjustable from 0.0 to 228.0 ms.

Rel Time (release time) is the time for the gate to ramp from open to closed (reverse if Ducking is on) after the gate timer has elapsed, adjustable from 0 to 3000 ms.

LFO Rate sets the speed of modulation of the delay lines with a range of 0.01 to 10 Hz.

LFO Dpth sets the maximum detuning depth of the LFO-modulated delay lines, with a range from 0 to 50 cents (= 1/2 semitone).

Tap Dly adds extra delay in front of the LFO modulated delay taps from 0 to 230 ms.

L/R Phase or **LFOn LRPhs** adjusts the relative phases of the LFOs for the left and right channels in the stereo Choruses.

Flanger

Flanging is the process of adding or subtracting a signal with a time-displaced replica of itself, which results in a series of notches in the frequency spectrum, generally referred to as a comb filter. In the PC4, the flanger is a multi-tap delay line, all (but one) of whose taps can have their lengths modulated up and down by a low frequency oscillator (LFO). The rate of the LFO is expressed in Tempo.

StatDlyLvl (Static Delay Level) is the level of the first, non-moving tap. Negative values invert the polarity of the tap. The range is -100 to 100%; 0% turns the tap off.

DlyCrs and **DlyFin** are the coarse and fine length controls for the Static delay (StatDly...) and for the minimum value of the moving delays (Dlyn...). The coarse range is 0 to 228 ms, and the fine range adjusts the coarse range in samples (= 1/48,000 sec = 20.8µsec) from -127 to 127.

Xcurs Crs and **Xcurs Fin** determine how far the LFO-modulated delay taps can move from the center of their ranges. The total range of the LFO sweep is twice the excursion. If the excursion is set to 0, the LFO does not move and the tap behaves like a simple delay line set to the minimum delay. The coarse range is 0 to 228 ms; the range 0 to 5 ms is most effective for flanging. The fine range adjusts the coarse range in samples from -127 to 127.

Quantize

This effect produces digital distortion known as quantization noise, by limiting the number of bits available to the signal. See effect 329 "Aliaser."

The Effects Chain Editor

Effects Parameters

DynamRange (dynamic range) controls how many bits to remove from the signal data words. The lower the level, the greater the distortion. At 0 dB the hottest of signals will toggle between only two quantization levels, thereby producing a square wave. Every 6 dB added doubles the number of quantization levels, reducing the noise and getting closer to the original signal. If the signal has a lot of headroom (available signal level before digital clipping), then not all quantization levels will be reached. Range is 0 to 144 dB.

Headroom sets the available signal level before digital clipping. Setting this properly prevents the signal from getting too loud at low levels of DynamRange. You want to have it match the amount of level still available above the input signal: this is done by finding the DynamRange level at which the signal starts getting louder, and setting Headroom to match the DynamRange value. Range is 0 to 144 dB.

DC Offset adds a positive DC Offset to the input signal, which allows you to alter the position where digital zero is with respect to your signal. At low DynamRange settings, this can cause the output to “sputter.” Range is Off/-79.0 to 0.0 dB.

LaserVerb

LaserVerb is a type of reverb which produces a delayed train of closely spaced reflections, or impulses. As time passes, the spacing between the impulses gets wider, which creates a discernible buzzy pitch that gets lower as the spacing increases. The signal can be fed back into itself to extend the effect.

Dly Coarse is the overall delay length, which controls the duration or decay time. 0.5 sec is a good starting point. Range is 0 to 1.3 seconds in the 2 DSP unit version of the effect, and 0 to 2 seconds in the 3 DSP unit version.

Dly Fine adjusts the delay with a resolution down to 0.2 ms. Range is -20.0 to 20.0 ms. Spacing determines the starting pitch of the descending buzz and how fast it descends, by setting the initial separation of impulses and the subsequent rate of increasing impulse separation. The spacing between impulses is given in samples (20.8 μ s). At low values, the buzz starts at high frequencies and drops slowly, while at high values the buzz starts at a lower pitch and drops rapidly. Range is 0.0 to 40.0 samples, with a resolution of 0.2 sample.

Contour controls the overall shape of the reverb. When set to a high value, sounds passed through the reverb start at a high level, and it slowly decays. As the control value is reduced, it takes more time for the effect to build up before decaying. At a value of around 34%, the reverb behaves like a reverse reverb, building up to a hit. When it is set to zero, the effect acts like a simple delay. Range is 0 to 100%.

Filters

Resonant Filter

Frequency (or Freq) is the fixed resonant frequency of the filter. Its range is 16 to 8372 Hz.

Envelope Filter

Envelope Filter is a resonant filter whose center frequency can be made to vary according to the level of the incoming signal.

There are four types of Resonant Filter effects in the PC4. All of them have these parameters in common:

Filter Type (or **FiltType**) can be Lowpass, Highpass, Bandpass, or Notch (band-cut). Resonance is the resonance of the filter, adjustable from 0 to 50 dB.

Filter Type can be Lowpass, Highpass, Bandpass, or Notch (band-cut).

Min Freq is the minimum resonant frequency of the filter, that is, the filter frequency when the input gain is below the triggering threshold. Its range is 16 to 8372 Hz.

Sweep determines how far the resonant frequency moves when the input level increases. At positive levels it moves up in pitch, and at negative levels it moves down. The highest possible resonant frequency is 8372 Hz, the lowest is 0 Hz. This parameter's range is -100% to +100%.

Resonance is the resonance of the filter, adjustable from 0 to 50 dB.

Atk Rate adjusts the upward slew of the attack portion of the envelope detector. Range is 0 to 300.0 dB/sec.

Rel Rate adjusts the downward slew of the release portion. Range is 0 to 300.0 dB/sec.

Smooth Rate slows down the envelope follower. If it is set to a lower rate than Atk Rate or Rel Rate, it can dominate those parameters. Range is 0 to 300.0 dB/sec.

Triggered Filter

The Triggered Filter is a sweeping resonant filter that triggers when a certain input threshold is reached, and then follows its own envelope, consisting of an instantaneous attack and an exponential release, rather than the envelope of the input signal.

Max Freq is the resonant frequency of the filter at the peak of the internal envelope. It can be set lower than Min Freq (above), in which case the filter will sweep downwards, then back up. Range is 16 to 8372 Hz.

Trigger is the input-signal threshold at which the envelope detector triggers. Range is -79 to 0 dB.

The Effects Chain Editor

Effects Parameters

Retrigger is the input-signal threshold at which the envelope detector resets, so that it can trigger again. This parameter is only useful when it is set below the value of Trigger. Range is from -79 to 0 dB.

Env Rate is the envelope detector decay rate. This can be used to prevent false triggering. When the signal envelope falls below the retrigger level, the filter can be triggered again when the signal rises above the trigger level. Since the input signal can fluctuate rapidly, it is necessary to adjust the rate at which the signal envelope can fall to the retrigger level. The range is 0 to 300.0 dB/sec.

Rel Rate is the downward slew (release) rate of the triggered envelope generator. The range is 0 to 300.0 dB/sec.

Smth Rate slows down the envelope follower. If set lower than the release rate, it will dominate it. You can also use the smoothing rate to lengthen the attack of the internal envelope. The range is 0 to 300.0 dB/sec.

LFO Filter

The LFO filter is continuously swept between two resonant frequencies over a period of time. The LFO frequency, expressed in BPM and beats, can be fixed or set to follow System tempo.

Min Freq and **Max Freq** are the low and high limits of the resonant frequency as the filter is swept. You can set the Min Freq higher than the Max Freq, in which case the filter will sweep “upside down” relative to the controlling clock. The range for both is 16 to 8372 Hz.

LFO Shape is the waveform type for the LFO. Choices are Sine, Saw+, Saw-, Pulse, and Tri.

LFO PlsWid (Pulse Width). When the LFO Shape is set to Pulse, this sets the pulse width as a percentage of the waveform period. When the width is set to 50%, the result is a square wave. This parameter has no effect if other waveform types are chosen. Range is 0 to 100%.

LFO Smooth smooths (removes the higher harmonics from) the Saw+, Saw-, and Pulse waveforms. A Sawtooth wave becomes more like a triangle wave, and a Pulse wave becomes more like a sine wave. Range is 0 to 100%.

Distortion

Distortion effects on the PC4 may also include a parametric equalizer or a cabinet simulator.

Dist Drive applies a boost to the input signal to overdrive the distortion effect into soft clipping. This will tend to make the signal very loud, so you may have to reduce the Out Gain as this parameter is increased. Range is 0 to 96 dB.

Warmth is a lowpass filter in the distortion control path. This filter may be used to reduce some of the harshness of some distortion settings without reducing the bandwidth of the signal. Range is 16 to 25088 Hz.

Highpass allows you to reduce the bass content of the distortion content in the smaller distortion effects that don't have true parametric EQ. Range is 16 to 25088 Hz.

Cab Preset selects from eight cabinet simulations which have been created based on measurements of real guitar amplifier cabinets. The presets are: Basic, Lead 12, 2x12, Open 12, Open 10, 4x12, Hot 2x12, and Hot 12.

Cab Bypass switches on and off the cabinet-simulation part of the effect. When this is set to "In", the cabinet simulation is active; when it is "Out", there is no cabinet action.

Cabinet HP and **Cabinet LP** are highpass and lowpass filters to set the frequency response limits of the cabinets. Range of both filters is 16 to 25088 Hz.

Polydistort

This is a more complex distortion effect that provides two, four, or six stages of distortion.

Curve n controls the curvature of the individual distortion stages. 0% is no curvature (no distortion at all). At 100%, the curve bends over smoothly and becomes perfectly flat right before it goes into clipping. Maximum value is 127%.

LP n Freq are shelving frequencies for one-pole lowpass filters on each of the distortion stages. LP0 Freq handles the initial low pass prior to the first distortion stage. The other low pass controls follow their respective distortion stages. Range is 16 to 25088 Hz.

Rotating Speakers

An effect that includes Rotating Speakers breaks the signal into two frequency bands, "rotates" each band separately through a virtual speaker, and then combines the outputs with a pair of virtual "microphones" whose angle relative to the speakers is adjustable. A number of very sophisticated parameters have been included in the Rotating Speakers effect, to give the effect a great degree of realism. Because of the complexity of the effects, you might want to approach any parameters that seem a little obscure to you with caution.

Roto InOut engages or bypasses the rotary speaker effect.

There are four virtual microphones, with two each on the woofer (LoMic A and LoMic B) and on the tweeter (HiMic A and HiMic B). Each microphone has:

Pos (position), the angle of the microphone from the front of the virtual speaker, from -180 to 180degrees;

Lvl (level) from 0 to 100%; and **Pan**, the left/right panning of the microphone's output, from -100% (full left) to 100% (full right). Other parameters:

Lo Beam W and **Hi Beam W** set the acoustic radiation patterns ("beam width") of the two drivers in the rotating speaker. If you imagine looking down on the rotating speaker, this is the angle between the -6 dB levels of the beam. The range is from 45° to 360°. At 360°, the driver is omnidirectional.

The Effects Chain Editor

Effects Parameters

Xover (Crossover) is the frequency at which high and low frequency bands are split and sent to separate rotating drivers. The range is 16 to 25088 Hz.

Lo Gain and **Hi Gain** are the gains of the signal passing through the rotating woofer or tweeter, respectively. The range is Off/-79.0 to 24.0 dB.

Lo Size and **Hi Size** are the effective sizes (radius of rotation) of the rotating speakers in millimeters. This affects the amount of Doppler shift or vibrato of the low frequency signal. The range is 0 to 250 mm.

Lo Trem and **Hi Trem** control the depth of tremolo (amplitude modulation) of the signals. It is expressed as a percentage of full scale tremolo. The range is 0 to 100%.

LoResonate and **HiResonate** are simulations of cabinet resonant modes expressed as a percentage. For realism, you should use very low settings. The range is 0 to 100%.

Lo Res Dly and **Hi Res Dly** are the number of samples of delay in each resonator circuit in addition to the rotation excursion delay. The range is 10 to 2550 samples.

LoResXcurs and **HiResXcurs** are the number of samples of delay to sweep through the resonator at the rotation rate of each rotating speaker. The range is 0 to 510 samples.

ResH/LPhs sets the relative phases of the high and low resonators. The angle value in degrees is somewhat arbitrary and you can expect the effect of this parameter to be rather subtle. The range is 0 to 360.0 degrees.

Mic Angle is the angle of the virtual microphones in degrees from the “front” of the rotating speaker. For the left microphone the angle increases clockwise (when viewed from the top), while for the right microphone the angle increases counter-clockwise. Assigning a MOD to this parameter should be done with caution: real-time adjustments to it will result in large sample skips, which will cause clicks in the signal passing through. The range is 0 to 360.0 degrees. (In Distort + Rotary only.)

The following parameters relate to rotation speed:

Speed sets the rotating speakers to run at either the slow rate or the fast rate. Brake, when set to “On”, slows the rotating speakers to a halt.

Lo Mode, in the “Normal” setting, will give you full control of the low frequency speaker with the Speed parameter. The “NoAccel” setting will hold the low frequency speaker at the slow speed, and the Speed parameter will have no effect on its speed, though Brake will still work. In the “Stopped” position, the low frequency speaker will not spin at all.

Lo Slow and **Hi Slow** are the rotation rates in hertz (Hz) of the speakers when Speed is set to “Slow.”

Lo Fast and **Hi Fast** are the rotation rate in hertz (Hz) of the speakers when Speed is set to “Fast.” **LoSlow>Fst** and **HiSlow>Fst** are the times for the speakers to accelerate from the slow speed to **LoFst>Slow** and **HiFst>Slow** are the times for the speaker to decelerate from the fast speed to the slow speed.

LoAccelCrv and **HiAccelCrv** are the shapes of the acceleration curves for the speakers. 0% is a constant acceleration. Positive values cause the speaker to speed up slowly at first then quickly reach the fast rate. Negative values cause a quick initial speed-up then slowly settle in to the fast speed. If set to a low negative value, it will overshoot.

LoSpinDir and **HiSpinDir** are the directions of rotation of the speakers. The choice is clockwise (CW) or counter-clockwise (CCW).

Vibrato/Chorus

The Vibrato/Chorus effect simulates the vibrato and chorus effects on a tone wheel organ, and is used in conjunction with the Rotary Speaker. It has several unique parameters:

VibChInOut is an in/out switch for the Vibrato/Chorus effect.

Vib/Chor is the type of Vibrato/Chorus effect to be used. The choices are from three vibratos, “V1”, “V2”, “V3”, or three choruses, “C1”, “C2”, “C3.”

Tremolo and AutoPan

Tremolo is amplitude modulation using an LFO. AutoPan moves the signal between the left and right channels, using an LFO. They have several parameters in common and several unique ones.

LFO Rate is the rate of the LFO. The range is 0 to 10.00 Hz, or 0 to 12.00 x the tempo.

Rate Scale multiplies the speed of the LFO rate into the audio range. The range is 1 to 25088 x. When above 16x, the values increment in semitone steps. When the LFO Rate is set to 1.00 Hz, the value of this parameter is equal to the LFO frequency in Hertz.

LFO Shape is the waveform type for the LFO. Choices are Sine, Saw+, Saw-, Pulse, and Tri.

LFO PlsWid or Pulse Width. When the LFO Shape is set to Pulse, this sets the pulse width as a percentage of the waveform period. When the width is set to 50%, the result is a square wave. This parameter has no effect if other waveform types are chosen. Range is 0 to 100%.

AutoPan

Origin determines the axis for the panning motion. At 0%, the panning is centered between the speakers. Positive values shift the axis to the right, while negative values shift it to the left. At -100% or +100% (the range limits), there is no panning action.

ImageWidth is the width of the original input program material before it is auto-panned. At 0% (minimum), the input image is shrunk to a single point source, allowing maximum panning excursion. At 100% (maximum), the original width is maintained so no panning can occur.

Pan Width controls the amount of pan excursion. It is the percentage of total panning motion available after Origin and ImageWidth are set. Range is 0 to 100%.

The Effects Chain Editor

Effects Parameters

CentrAtten (Attenuation) is the amount the signal level drops as it is panned through the center of the stereo image. For the smoothest tracking, a widely accepted subjective reference is -3dB. Values above -3dB will cause somewhat of a bump in level as an image passes through the center, while values below -3dB will cause a dip. Range is -12 to 0 dB.

Tremolo

Depth controls the amount of attenuation applied when the LFO is at its deepest excursion point. Range is 0 to 100%.

LFO Phase shifts the phase of the tremolo LFO relative to the beat reference. Range is 0.0 to 360.0 degrees.

50% Weight is the relative amount of attenuation added when the LFO is at the -6dB point. This causes the LFO shape to bow up (positive values) or down (negative values). Range is -16 to 3 dB.

L/R Phase sets the phase relationship of the channels. “In” flips the left channel’s LFO out of phase, with the result that the effect turns into an auto-balancer. “Out” leaves the left LFO alone.

Pitcher

Pitcher applies a filter to the input signal which has a series of peaks in the frequency response.

These peaks are normally adjusted so that their frequencies are all multiples of a specific, selectable frequency, which imposes a strong sense of pitch at the selected fundamental frequency.

Pitch. The fundamental pitch imposed upon the input, in MIDI note numbers from C-1 to G9. Ptch Offst is an offset from the pitch frequency in semitones, from -12.0 to 12.0. It can be useful to assign pitch bend, a ribbon, or another continuous controller to this parameter through a MOD.

Odd Wts, Pair Wts, Quartr Wts, Half Wts are parameters that control the shape of the frequency response of Pitcher. An exact description of what each one does is, unfortunately, impossible, since there is a great deal of interaction between them. For more information and examples, see the KSP8 Algorithm Reference Guide available as a free download at www.kurzweil.com.

Ring Modulation

Ring modulation multiplies two signals (the “carrier” and the “modulator”) together to produce unusual, often non-harmonic, overtones. The Ring Modulator effect in the PC4 has two modes: “**L*R**” in which two mono signals are modulated together; and “**Osc**”, in which the input is stereo, and it is modulated with the sum of five waveforms that are generated from oscillators within the effect itself. Four of these oscillators are sine waves, while one (Oscillator 1) offers a selection of waveforms.

Wet/Dry. When the effect is in “L*R” mode, this controls how much of the left signal only is passed dry (the right signal isn’t passed dry at all).

Mod Mode selects between the two modes, L*R or Osc.

Osc1 Lvl is the level of Oscillator 1, from 0 to 100%.

Osc1 Freq is the frequency of Oscillator 1, from 16 to 25088 Hz.

Osc1 Shape is the waveshape of Oscillator 1, selectable from Sine, Saw+, Saw-, Pulse, and Tri.

Osc1PlsWid (Pulse Width). When Osc1 Shape is set to Pulse, this sets the pulse width as a percentage of the waveform period. When the width is set to 50%, the result is a square wave. This parameter has no effect if other waveform types are chosen. Range is 0 to 100%.

Osc1Smooth smooths (removes the higher harmonics from) the Saw+, Saw-, and Pulse waveforms. A Sawtooth wave becomes more like a triangle wave, and a Pulse wave becomes more like a sine wave. Range is 0 to 100%.

The other four oscillators, **Sine2** through **Sine5**, each have **Lvl** and **Freq** controls.

Stereo Simulation

The Mono to Stereo effect converts a monaural input to simulated stereo output.

In Select selects the input signal to be “stereo-ized.” It can be Left, Right, or both: (L+R)/2. **CenterGain** is the level of the summed left and right channels. Range is Off/-79.0 to 24.0 dB.

Diff Gain is the level of the difference signal produced, which is the spatial component of the stereo signal. Range is Off/-79.0 to 24.0 dB.

DiffBassG controls the gain of a bass-shelf filter on the difference signal. By boosting the low frequency components of the difference signal, you can increase the sense of acoustic envelopment. Range is -79.0 to 24.0 dB.

DiffBassF is the transition frequency for the bass-shelf frequency. Range is 16 to 25088 Hz.

The processed signal is split into three frequency bands—Lo, Mid, and High—each of which can be delayed and panned separately.

The Effects Chain Editor

Effects Parameters

Crossover1 and **2** are the two Crossover frequencies at which the band-split filters split the signal into three bands. The two parameters are interchangeable: either may have a higher frequency than the other. Range is 16 to 25088 Hz.

Pan [*High/Mid/Low*] sets the pan position for each band. Range is -100% (fully left) to 100% (fully right.)

Delay [*High/Mid/Low*] sets the delay for each band. Range is 0 to 1000 ms.

Stereo Image

This effect provides enhancement for a stereo signal. It also features a stereo correlation meter. It uses some parameters from **Mono to Stereo** and some from **Stereo Analyze** (following).

Chapter 5

Keymap and Sample Editing

The Keymap Editor

The Keymap Editor lets you customize the PC4's factory preset keymaps and save them to RAM. You can also build your own keymaps from scratch (see [“Building a Keymap” on page 5-8](#)).

A keymap contains a set of samples and parameters determining how each sample will play when you trigger a note. Each layer can use up to two keymaps (for stereo samples).

Each keymap consists of a set of keyboard note ranges (the entire span of each keymap is from C 0 to G 10). Each range has a ROM or RAM sample root assigned within the range. Within each key range, the sample root is typically transposed up and down to play different pitches for each note.

For acoustic instrumental sounds, keymaps with more samples and key ranges generally make the sound more realistic, since this causes less pitch shifting of the sample root within each key range.

You can mix samples of different timbres within a single keymap, and even tune individual keys to any pitch by defining key ranges to single notes and assigning samples to each of those notes. Many of the drum kit keymaps in ROM have about 20 key ranges, with several different timbres assigned as the sample roots.

You can create a keymap with a single key range that spans from C 0 to G 10, if you want to stretch a single sample root from C 0 to G 10. Samples can be transposed upward by an octave from the sample's original pitch, or transposed downward without limit.

Think of a keymap as if it were a single piece of string, divided into different sections that adjoin one another. Sections cannot overlap. If you have one range that goes from C4 to F4 and another that goes from F#4 to C5, then if you change the first range to be C4 to G4, the second one will change to be G#4 to C5.

Keymaps can be set to play different samples depending on the attack velocities of each note played. For example, Keymap 7 Piano 3Vel L has 3 velocity ranges. See [“Velocity Ranges \(VELRNG\)” on page 5-5](#).

Keymap and Sample Editing

The Keymap Editor

The Keymap Editor is accessed within the Program Editor. On the Program Editor Keymap page, select a Keymap and press the **EDIT** button to enter the Keymap Editor.

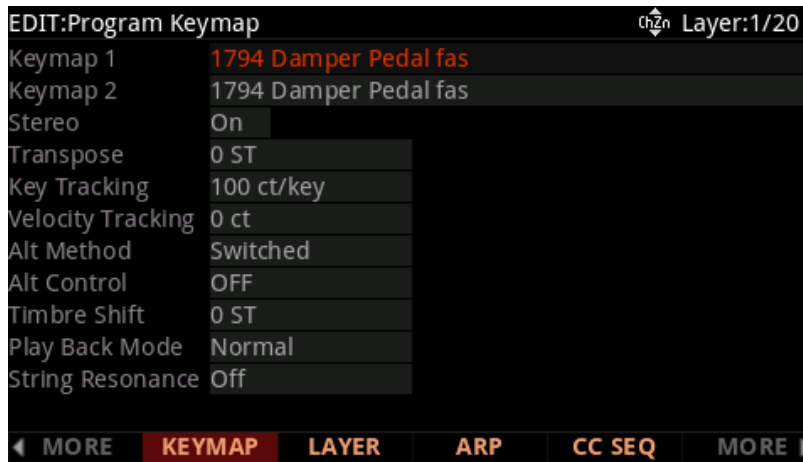

The Keymap Editor page looks like this:

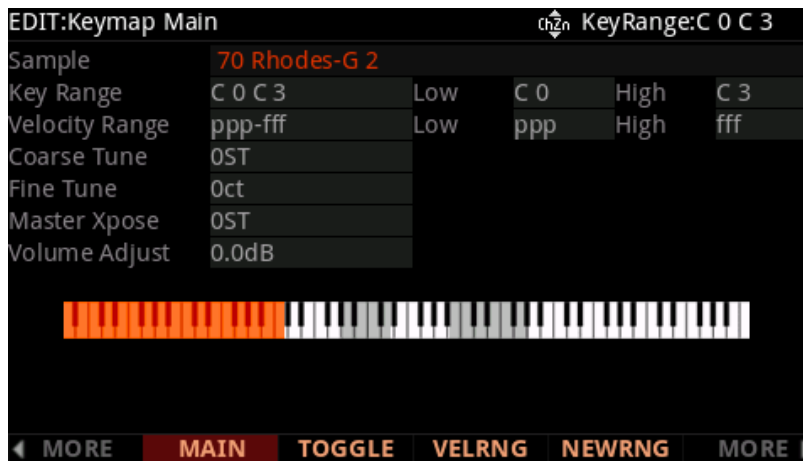

Keymap Editor Parameters

Sample

This is where you assign a sample root to the current key range. Depending on the nature of the sample root—an individual sample or a block of sample roots—the sample’s name looks a bit different in the display. Each sample’s name consists of three parts: a numeral, a name, and a note number—for example, **999 Silence-C4**. Additionally, the name of stereo samples will end with an **S**. (To use a stereo sample, the Stereo parameter must be set to **On** in the Program Editor, and two keymaps must be selected. See [“Stereo” on page 3-40](#) for details.)

The numeral is the sample block ID. If the sample object is an individual sample, the sample block ID is the same as the sample's object ID. If the sample object is a group of sample roots, the object ID of the first root in the group determines the sample block ID. The remaining roots in the block have the same ID, and differ only in their note numbers.

Next comes the name of the sample, which typically describes the sample's timbre. The final part of the sample's name refers to the pitch at which it was originally sampled. For many timbres, multiple samples are made at various pitches. As you scroll through the Sample list, you'll see only the pitch of the sample change until you reach the next sample block. The sample's original pitch is set in the Sample Editor (see [“Root Key” on page 5-11](#)). This determines which key will play the sample at its original pitch when a sample is used in a key range (see [Key Range](#) below).

Key Range

A keyrange is a range of keyboard keys that plays one sample (per velocity range, see [“Velocity Ranges \(VELRNG\)” on page 5-5](#) below for details). Each sample in a key range (per velocity range) is transposed based on each sample's RootKey parameter so that it plays at the correct pitch on the keyboard relative to its root key (see [“Editing Samples” on page 5-10](#) for details on the RootKey parameter). Other keys within the key range transpose the sample chromatically relative to the root key. Sample pitch relative to the root key can also be offset using the [Coarse Tune](#) and [Fine Tune](#) parameters, see below).

The **KeyRange** parameter shows you which key range you're currently viewing or editing (key ranges are named by their lowest and highest notes). Changing the value of the **KeyRange** parameter selects from the available key ranges, and allows you to view or edit the sample assignment and other parameters of the selected key range. When the Key Range parameter is selected, you can also scroll through available key ranges using the Alpha Wheel or the Previous-/Next+ buttons. Multiple key ranges are only shown if the current Keymap uses more than one key range. If the top line of the Edit Keymap page displays KeyRange, you can scroll through the available key ranges with any parameter on the page selected using the CHANNEL/LAYER/ZONE/TRACK buttons. (Press the TOGGLE soft button to toggle the top line between displaying KeyRange and VelRange.)

With the Keyrange parameter selected, keyranges can also be selected by holding the **Enter** button and playing a key. The keyrange assigned to that key will be selected.

Low Key (Lo), High Key (Hi)

With these parameters you can use any of the data entry methods to change the low and high notes of the current key range. You can extend a key range to the full capacity of the PC4 (C 0 to G 10). If you extend the current key range into another, the boundaries of the other key range will become shortened to accommodate the key range you are extending. If the keyrange you are extending covers another keyrange, the other key range will be deleted.

The setting for the low key cannot be higher than the setting for the high key. Similarly, the setting for the high key cannot be lower than the setting for the low key.

Keymap and Sample Editing

The Keymap Editor

Velocity Range

This parameter shows the keyboard velocity range (in dynamic levels) that will trigger a sample for the current KeyRange. In a key range with more than one velocity range, each velocity range can use a different sample, as well as different CoarseTune, FineTune, and VolumeAdjust settings. Velocity ranges are intended for use with instrument samples recorded at different velocities. This helps to make playing sampled instruments sound more realistic. Sample volumes are also scaled based on keyboard velocity within each velocity range. Velocity ranges for the current Keymap are set using the VELRNG soft button (see [Velocity Ranges \(VELRNG\)](#) or the [Low Velocity \(Lo\)](#), [High Velocity \(Hi\)](#) parameters below). All keyranges in a Keymap share the same set of velocity ranges. Up to eight velocity ranges can be used.

When the Velocity Range parameter is selected, you can scroll through available velocity ranges using the Alpha Wheel or the **Previous-/Next+** buttons. Multiple velocity ranges are only shown if the current Keymap uses more than one velocity range. If the top line of the Edit Keymap page displays VelRange, you can scroll through the available velocity ranges with any parameter on the page selected using the CHANNEL/LAYER/ZONE/TRACK buttons. (Press the TOGGLE soft button to toggle the top line between displaying VelRange and KeyRange).

Low Velocity (Lo), High Velocity (Hi)

Use these parameters to set the velocity range of the current key range. If you extend the current velocity range into another, the boundaries of the other velocity range will become shortened to accommodate the velocity range you are extending. If the velocity range you are extending covers another velocity range, the other velocity range will be deleted.

Coarse Tune

Coarse Tune allows you to transpose a sample for a given range. This is extremely useful when you have set the Root key of the sample for one note but want to assign the sample to a different part of the keyboard and still be able to play it without transposition (see [“Root Key” on page 5-11](#) for details). For example, if you originally set the Root key at C4 but want the sample assigned to C3, you would set Coarse Tune to 12ST, transposing it up one octave. Now the original pitch will play at C3, one octave down. If you examine the drum and percussion kit keymaps in ROM, you will see that we have done this. Most of our ROM drum samples have the Root key set at C4.

There's a short cut for adjusting the Coarse Tune automatically so that the sample plays with minimal transposition in the assigned key range. See [Special Double Button Presses in the Keymap Editor on page 5-7](#).

Fine Tune

This gives you further pitch control. Once the sample's pitch is close to the desired note, use the Fine tune to sharpen or flatten it as much as a half-semitone.

Master Transpose (Master Xpose)

This parameter does not really pertain to the keymap itself. Instead it is identical to the Transpose amount set with the cheek block **Transpose** buttons or OCTAV-/OCTAV+ soft buttons on the Program and Multi mode select pages. If you change the transpose value here, the same value will be reflected by the **Transpose** button LEDs as well as in the top bar of the Program and Multi mode select pages, and vice versa. It transposes the entire instrument globally. The Master Xpose parameter allows you to easily see the transpose value while in the keymap editor. It is also useful for assigning samples across the entire keyboard when using a keyboard that has fewer than 88 notes.

Volume Adjust

Here you can adjust the volume of the notes in the current key range. This enables you to make each key range play at the same volume even if the samples in the various ranges were recorded at different volumes.

The Soft Buttons in the Keymap Editor

TOGGLE

Pressing the TOGGLE soft button switches the function that the CHANNEL/LAYER/ZONE/TRACK buttons perform while on the Edit Keymap page. Press the TOGGLE soft button to toggle the top line between displaying **KeyRange** or **VelRange**. If the top line of the page displays **KeyRange**, then the CHANNEL/LAYER/ZONE/TRACK buttons will scroll between the available key ranges in the key map (if the current key map has more than one key range). The note range for each key range will also be displayed on the top line. If the top line of the page displays **VelRange**, then the CHANNEL/LAYER/ZONE/TRACK buttons will scroll between the available velocity ranges in the key map (if the current key map has more than one velocity range). The dynamic range for each velocity range will also be displayed on the top line.

Velocity Ranges (VELRNG)

Press the VELRNG soft button to view the VEL RANGES page. Use the VEL RANGES page to add, edit or delete velocity ranges for the current keymap. The VEL RANGES page shows a chart of a keymap's entire available dynamic range, from most quiet (ppp) to most loud (fff). Velocity ranges can also be adjusted from the Edit Keymap page, but the VEL RANGES page provides a chart as a visual aid. Each keymap can be split into a maximum of eight velocity ranges. Each key range in a keymap can use its own sample for each velocity range. All key ranges in a keymap share the same velocity ranges.

Press the **Split** soft button to split the currently selected velocity range into two ranges (until the maximum of eight velocity ranges have been created). Press the **Delete** soft button to delete the currently selected velocity range. Press the **Exit** soft button to return to the Edit Keymap page.

Keymap and Sample Editing

The Keymap Editor

On the VEL RANGES page, the currently selected velocity range is highlighted in the chart, and its name is displayed in the VelRange field. With the VelRange field selected, you can use the Alpha Wheel or Previous-/Next+ buttons to move between the available velocity ranges (if there is more than one velocity range available). You can also use the CHANNEL/LAYER/ZONE/TRACK buttons at any time to move between the available velocity ranges. If there is more than one velocity range available, you can adjust the dynamic range of each using Lo and Hi parameters. These Hi and Lo parameters are the same as the Low Velocity (Lo) and High Velocity (Hi) parameters on the Edit Keymap page (see [“Low Velocity \(Lo\), High Velocity \(Hi\)” on page 5-4](#) for details). Changes made with either set of parameters are shown on both pages.

New Range (NEWRNG)

The NEWRNG soft button lets you define a new keyrange to edit, whether it's to assign a different sample, or to adjust the pitch or volume. Just press NEWRNG, then play the note you want as the low note, then the high note. The PC4 will prompt you for each note. When you trigger the high note, you'll return to the Keymap-editor page, and the new keyrange you defined will be selected. The next change you make will affect only that edit range.

If you set a new keyrange that's completely within an existing key range, the existing key range will be split into two keyranges, with the new keyrange between the two. At this point, you must change at least one parameter of the new keyrange before editing a different keyrange, otherwise the new keyrange will be merged with the adjacent keyranges. If you set a new keyrange that overlaps part or all of another key range, the sample assigned to the lower key range will be applied to the new keyrange. Again, at this point you must change at least one parameter of the new keyrange before editing a different keyrange, otherwise the new keyrange will be merged with the lower keyrange that it overlapped.

ASSIGN

The ASSIGN soft button lets you select a sample, then specify the key range to which it's assigned. This enables you to insert a new key range within the current keymap. When you press the ASSIGN soft button, a dialog appears that prompts you to select a sample from the Samples list. Scroll through the list, then press the OK soft button. You'll then be prompted to define the new key range by playing the notes you want to be the lowest and highest notes of the range. (Press the **Cancel** soft button if you change your mind.) When you trigger the low and high notes, the new key range is inserted. If the new key range partially overlaps an adjacent key range, the existing key range will be adjusted to accommodate the new range. If the new key range completely overlaps an existing key range, the original key range will be replaced.

DELETE

Press the DELETE soft button to delete the current Keymap (factory Keymaps can not be deleted).

COMPARE

Press the COMPARE soft button to temporarily recall an unedited version of the Keymap, allowing you to compare your edited Keymap with the original Keymap. Press the COMPARE soft button again to return to the edited version of the Keymap.

Save User Keymaps

After making changes to a Keymap, press the Exit or Save buttons to view the Save Dialog. Use the Save Dialog to save the Keymap by selecting a User ID to save to, and renaming the Keymap if desired. Saving changes to a keymap is very similar to saving a user program, see [Save User Programs on page 2-10](#) for more details.

Special Double Button Presses in the Keymap Editor

Suppose you have a sample whose root key is C 4, and you want to assign it to A 0, because you don't expect to play it often. If you want it to play back without transposition, you'll have to adjust the Coarse Tune parameter. Calculating the right value for Coarse Tune can get tedious if you're assigning a large number of samples. Fortunately, there's a short cut.

1. Assign a sample root to a key range, either using the Lo, Hi, and Sample parameters or using the ASSIGN soft button.
2. Highlight the value of the Coarse Tune parameter.
3. Press the **Previous/Next** buttons at the same time. The value of Coarse Tune changes automatically. If the sample is assigned to one note, the PC4 sets Coarse Tune so that the note plays the sample without transposition. If the sample is assigned to a range of notes, the PC4 sets Coarse Tune so that the middle note of the range plays the sample without transposition.

Building a Keymap

To build a new keymap, start in Program Mode and select program **2046 Editor Template**. Then go to Program Edit Mode by pressing the **EDIT** soft button. Next press the **KEYMAP** soft button, and the KEYMAP page will appear. The Keymap parameter **999 Silence** will be automatically selected. This makes it easier to recognize the key ranges that have samples assigned to them when you start assigning samples. You can actually choose any program or keymap you want to start with, but by choosing these, you are starting with a “blank slate.”

With the Keymap parameter still selected, press the **EDIT** button, and you’ll enter the Keymap Editor. The Key Range parameter will be automatically selected, and you see its values: C 0 to G 10 (the entire MIDI keyboard range). The Sample parameter will have a value of **999 Silence-C 4**.

Now you’re ready to start assigning samples to key ranges within the keymap. We’ll assume that you’ve loaded samples with roots at C 1, C 2, C 3, etc. and that you plan to assign a root to each octave. To begin, press the **ASSIGN** soft button. The display will prompt you to select a sample. Use the Alpha Wheel to scroll to one of your samples, or type its ID on the alphanumeric pad and press **Enter**. When you’ve found the sample you want to use, press the **OK** soft button. The display will say “Strike low key...” Trigger A 0 (MIDI note number 21, the lowest A on a standard 88-note keyboard). The display will change to say “Strike High Key...” Now trigger F 1 (MIDI note number 29). The display will return to the Keymap-editor page. The Key Range parameter will show A 0–F 1, and the Sample parameter will show the sample you selected when you started the range assignment.

Each sample in a key range is automatically transposed based on each sample’s RootKey parameter so that it plays at the correct pitch on the keyboard relative to its root key (see [“Editing Samples” on page 5-10](#) for details on the RootKey parameter). Other keys within the key range transpose the sample chromatically relative to the root key. Automatic transposition based on each sample’s RootKey is important if you want your sample to play in tune with other PC4 programs or other instruments. The PC4 makes this easy if your samples have the correct RootKey settings (as the PC4’s factory samples do). Generally you should set a keyrange so that the sample’s RootKey (displayed at the end of the sample name) is in the middle of the range. If you set a key range that does not cover the sample’s RootKey, the sample will have to automatically transpose by many semitones, and will likely not sound correct. Samples are also limited to an octave of upward transposition from the sample’s original pitch. If you set a keyrange too high based on the Root Key, some samples may not be able to transpose upward far enough to play in tune, and many keys may play the same note (the highest note that the sample can be transposed to). Automatic transposition relative to the root key can be offset using the Coarse Tune and Fine Tune parameters on the Edit Keymap page (see [Coarse Tune](#) and [Fine Tune on page 5-4](#)).

Continuing with the example, press the ASSIGN soft button again. Select another sample root at the prompt, and press the OK soft button. Now trigger F# 1 for the Low Key prompt, and F 2 for the High Key prompt. At this point you've defined two key ranges, the first from A 0 to F 1, and the second from F# 1 to F 2. You can repeat the process as many times as you want, creating a new key range each time.

Once you have your samples assigned, you may need to transpose them so that they play back at the correct pitch within the range you have chosen. To do this, highlight the Key Range parameter, scroll to the range you need, then highlight the Coarse Tune parameter. Adjust Coarse Tune to bring the sample to the proper pitch within that key range. Then scroll back up to the Key Range parameter, select the next range, and continue as needed.

Here's a fairly important point that may or may not affect your keymap construction. Suppose you want to build a keymap that uses the same sample in several adjacent key ranges, and you plan to add a bit of detuning to the samples in each range. You might think that you could build the keymap first, then go into the Sample Editor and tweak the sample settings of each keyrange when the keymap is finished. Yes, but...

Suppose you used the technique we described above to assign a vocal sample whose root was C 4 to a key range from A 3 to E 4. Then you assigned the same sample to a key range from F 4 to B 4. You might be surprised to find that when you finished the F 4–B 4 key range and the Keymap-editor page reappeared, the current key range would not be F 4 to B 4, but A 3 to B 4! This is because the PC4 automatically merges adjacent key ranges that are identical (this is done to save memory). Therefore, some parameter must be different in each adjacent key range you create if you want to build keymaps using the technique we just described. So if you want to use the same samples in adjacent key ranges with, for example, minor pitch or volume modification, you should make those changes to the current sample on the Keymap-editor page *before* assigning the next range.

Editing Samples

To enter the Sample Editor, first select the program you wish to edit in Program mode. With the program selected, press the **EDIT** soft button to enter the Program Editor. In the program editor the **KEYMAP** page will be selected (if not press the **KEYMAP** soft button). With the **KeyMap** parameter selected on the **KEYMAP** page, press the **EDIT** button again to enter the Keymap Editor. On the Edit Keymap page, select the **KeyRange** parameter and use the Alpha Wheel or **Previous-/Next+** buttons to choose one of the available key ranges (if there is more than one keyrange). You can edit the existing sample of a keyrange, or choose a new sample for the keyrange and edit that. When the **Keymap** parameter is selected you can hold the **Enter** button and trigger notes to select different key ranges.

If you want to select a different sample, use the cursor buttons to select the **Sample** parameter. Use the Alpha Wheel to select a sample. Press the **EDIT** button once more, and you'll enter the Sample Editor. The sample will play through the effects of the current program. The name of stereo samples end with an **S**. To use a stereo sample, the [Stereo](#) parameter must be set to **On** in the Program Editor, and two keymaps must be selected, see [The KEYMAP Page on page 3-40](#).

The Sample Edit Main Page

On the Sample Main page, you'll set several parameters that affect the behavior of the current sample. These parameters affect the entire sample. The right side of the top line displays the root number and RootKey of the sample. For stereo samples, **L** or **R** is displayed after the Root# parameter to indicate that you are viewing parameters for the left or right channel of the sample. Use the CHANNEL/LAYER/ZONE/TRACK buttons to move between channels of stereo samples. Although you can edit parameters for the left and right channels of a sample, both channels can only be heard if the [Stereo](#) parameter is set to On in the Program Editor, and the same keymap is selected for the Keymap1 and Keymap2 parameters in the Program Editor. If the Stereo parameter is set to Off in the Program Editor, only the left channel of stereo samples will be heard in mono. If the sample is part of a group of sample roots, you can also use the CHANNEL/LAYER/ZONE/TRACK buttons to scroll through each sample in the group. A representative page is shown below:

EDIT:Sample Main		Root#:1 (G 2)	
Root Key	G 2	Loop Switch	On
Pitch Adjust	0ct	PlayBack	Normal
Volume Adjust	-8.5dB	Alt Sense	Normal
Alt Vol Adjust	-16.0dB	Ignore Release	Off
Decay Rate	4dB/s	Sample Rate	19959Hz
Release Rate	499dB/s	Number Samples	90Ks
Start Sample	0	Alt Start Sample	9953
Loop Sample	89842	End Sample	90046

MAIN

Root Key

The root key represents the keyboard key at which the sample will play back without transposition (that is, at the same pitch as the pitch of the original sample). Use the **Previous-/Next+** buttons or Alpha Wheel to select a RootKey note, or use the alphanumeric pad followed by the **Enter** button to enter a RootKey by MIDI note number.

Pitch Adjust

Use this parameter to change the pitch of the sample relative to the key from which it's played. Setting a value of 100cts, for example, will cause the sample to play back one semitone higher than normal. This parameter is handy for fine tuning samples to each other if they're slightly out of tune.

Volume Adjust

Uniformly boost or cut the amplitude of the entire sample.

Alternative Start Volume Adjust (AltVolAdjust)

This parameter sets the amplitude of the sample when the alternative start is used.

Decay Rate

This parameter defines how long the sample takes to decay (fade) to zero amplitude (silence). Decay Rate affects each sample individually, and is in effect only when the amplitude envelope for the program (the Mode parameter on the AMP ENV page in the Program Editor) is set to Natural. If Mode is User, the settings on the AMP ENV page override the setting for DecayRate.

DecayRate takes effect in the loop portion of the sample, after all the attack stages of the amplitude envelope are complete.

Release Rate

The release rate determines how long the sample will take to decay to zero amplitude when the note trigger is released. The higher the value, the faster the release rate. This release affects each sample individually, and is in effect only when the amplitude envelope for the program (the Mode parameter on the AMP ENV page in the Program Editor) is set to **Natural**. In this case, the release begins as soon as the note is released. If Mode is **User**, the settings on the AMP ENV page override the setting for ReleaseRate.

To create an extended sample loop that will play data after the sample's loop on key-up, set the Alternative Start sample pointer after the sample end pointer, then set a relatively low value for the release rate.

Loop Switch

This parameter activates or deactivates the looping of the currently selected sample. When set to On, the sample will loop according to the settings on the TRIM page. When set to **Off**, the sample will play through to its End point and stop.

Playback Mode (Playback)

This parameter lets you modify the direction in which the sample is played. Set it to a value of Reverse if you want the sample to play from its End point to its Start point. Choose a value of Bidirectional to cause the sample to play from Start to End, then reverse direction and play again from End to Loop and back, repeating until the note trigger is released (this works only when the Loop Switch parameter is set to **On**).

Alternative Sample Sense (AltSense)

This provides a convenient way to activate the alternative start of a sample. When set to Normal, the alternative start will be used when the Alt Switch control is On (this is set on [The KEYMAP Page](#)) or when the control source assigned to it is above its midpoint. When set to Reverse, the alternative start will be used when the Alt Switch control is Off, or when the control source assigned to it is below its midpoint.

Ignore Release (IgnRelease)

When set to a value of Off, the sample will release normally when the note trigger is released. When set to On, the note will not release, even when the note trigger is released. This setting should be used only with samples that normally decay to silence; non-decaying samples will play forever at this setting. This parameter is equivalent to the IgnRelease parameter on the LAYER page, but affects only the currently selected sample.

SampleRate and NumSamples

These parameters cannot be edited, but show the sample's sample rate and the sample's length in samples. Samples that are longer than 1 million samples are displayed as 1Ms.

The Sample Trim parameters below let you set the Start, Alternative Start, Loop, and End points of the current sample. The right side of the top line displays the root number of the sample. If the sample is part of a group of sample roots, you can use the CHANNEL/LAYER/ZONE/TRACK buttons to scroll through each sample in the group.

Selecting these parameters and adjusting their values enables you to modify how the sample plays back when notes are triggered. Each of these parameter points are expressed in individual samples. For example, a one second sample at a sample rate of 44,100Hz would have 44,100 values available to adjust for each of these parameters.

Start

The Start point determines the beginning of the current sample. You can truncate the beginning of the sample by increasing the value of the Start parameter. You might do this to remove silence at the beginning of a sample, or to remove some or all of the attack. You can't decrease the Start point of samples below zero.

Alternative Start

The Alternative Start parameter lets you set a second, optional start or end point for the current sample. The Alternative Start will be used when the Alt Control parameter on the KEYMAP page is set to On, or when Alt Control is assigned to a control source with a value above its halfway point. See [Alt Control on page 3-42](#) for details.

The Alternative Start can be set before, after, or at the same point as the Start or End. If you set the Alternative Start after the End, you can extend the play of looped samples. Normally, looped samples will play through to the End, then will loop back to the Loop point, and continue looping like this until the note is released, when they go into their normal release. If the Alternative Start is set after the End, looped samples will loop in the same way while notes are sustained. As soon as you release the notes, however, the samples will play through to the Alternative Start point before going into release.

Loop

The Loop parameter sets the beginning of the looped portion of the current sample. The Loop can be set at any point before the End, including before the Start and Alternative Start. If you try to move it after the End, the End will move with it.

Keymap and Sample Editing

Editing Samples

End

The End parameter sets the point at which the current sample will stop playback. Typically you'll use this parameter to trim unwanted silence off the end of a sample, although you can use it to shorten a sample as much as you want.



Note on Saving Samples: Trimmed portions of a sample are not saved. Trimmed portions before the Start, or Alternative Start points. Trimmed portions of a sample saved to a user ID will be deleted. Trimmed portions before the Start or Alternative Start points (whichever has a lower value) will be lost upon saving to a user ID, and whichever parameter had a lower value will have a value of zero the next time it is loaded (values for all other sample point parameters will be adjusted relatively). Trimmed portions after the Alternative Start or End points (whichever has a higher value) will be lost upon saving to a user ID. The original untrimmed sample is always available by selecting the sample's original factory ID number. Saving trimmed factory samples to user IDs will not change the sound of factory samples, keymaps, or Programs.

Chapter 6

Multi Mode

Use Multi Mode to play up to 16 split or layered Programs directly from the keyboard. Each of the 16 Zones in a Multi can have a different Program, controller settings, and MIDI transmit channel. Zones can also control external sound modules or computer software through a MIDI or USB cable.

To enter Multi Mode from another Mode, press and turn on the MULTI Mode button.

The PC4 powers on with Multi 1 selected, or the Multi that was selected the last time Global Mode was exited.

Selecting Multis

In Multi Mode, use any of the methods below to select a Multi.

Browse All Multis

Make sure the USER button is off, then use the ALPHA WHEEL or PREVIOUS and NEXT buttons to select a Multi from all of the available Multis.

Select a Multi by ID Number

The KEYPAD button allows you to use the numbers labeled on the CATEGORY buttons to select Multis by ID number. Use the CATEGORY buttons to type an ID number followed by pressing the ENTER button. Multis are not organized by category, so the KEYPAD button is always on in Multi Mode.

Select a Previously Saved User Multi

Press and turn on the USER button, then use the ALPHA WHEEL or PREVIOUS and NEXT buttons to browse only User Multis. To return to browsing Factory and User Multis, press and turn off the USER button.

Multi Mode

The Display

The Display

In Multi Mode, the top line of the display shows the current Mode, MIDI transposition, and MIDI In/Out activity indicators. If Quick Access view is selected the current Quick Access Bank number will be shown in the top right corner of the screen.

The currently selected Multi ID number and name are shown in the center of the display. If the selected multi is a user multi, the USER icon is displayed next to the multi name.



MIDI In/Out Activity Indicators

MIDI In/Out activity indicators are displayed at the top of the screen (shown as 2 MIDI port symbols with “I” for “in” and “O” for “out”). These indicators briefly light up when MIDI has been recently sent to or received by the PC4’s MIDI/USB ports. If the symbol is green, this indicates there has been MIDI activity on that port in the last few seconds. If the symbol is red, this indicates there has been communication with the external software editor on that port in the last few seconds. If the symbol is grey, this indicates there has been no MIDI activity on that port in the last few seconds.

OCTAVE Soft Buttons

The OCTAVE- and OCTAVE+ buttons can be used to change the tuning of notes played on the PC4 keyboard in octaves.

The current transpose amount is shown in the top line of the LCD display. Press both OCTAVE buttons simultaneously to reset the transposition to 0.

The OCTAVE buttons also transpose MIDI notes sent to the USB and MIDI Out ports.

SPLIT and LAYER Soft Buttons

Use the SPLIT and LAYER soft buttons to split and layer multiple Programs across the keyboard. For details see [The Split and Layer Soft Buttons on page 6-6](#).

VIEW Soft Button and Quick Access View

Press the VIEW soft button to switch between the default Large view, List view, and Quick Access view.

Quick Access view shows the names of 10 favorite Programs and/or Multis, which can be selected by pressing the corresponding numbers on the Keypad. To access more than 10 Programs/Multis, use the CHANNEL/LAYER/ZONE/TRACK buttons to select a different Quick Access Bank. Programs or Multis which are not stored in a Quick Access Bank can be browsed by using the ALPHA WHEEL or PREVIOUS/NEXT buttons.

When Quick Access view is selected, press and hold one of the Keypad buttons (0 through 9) to store the currently selected Program or Multi to a spot in the current Quick Access Bank. For details on Quick Access view, see [Display on page 9-3](#).



Note: When Quick Access view is selected, the Category buttons always select an entry in the current Quick Access bank, and can not be used to select a Multi by ID number, despite the state of the KEYPAD button.

Zone Info

To view additional information for each Zone from the Multi select page, set the Global Mode Show Zone Info parameter to On. See [Show Zone Info on page 9-7](#) for details.

Controllers

In Multi Mode, you can use the PC4 physical controllers (the Knobs, Sliders, Buttons, Wheels, and Pedals) to modify an instrument sound during a performance to add variation or expression.

Move a controller to view the assigned parameter name and value for each Zone in the display. Controllers can also be disabled or reassigned for each Zone in Multi Edit Mode. Because of this, controllers may function differently for each Zone in each Multi.



Note: Parameter assignments may not be visible if the VIEW soft button has been pressed, or the “Display” parameter in Global Mode has been changed.

CONTROL Section

In Factory Multis, the first 4 buttons and sliders are assigned to Zone On/Off and Zone Volume. Sliders 8 and 9 typically control Delay and Reverb amount. The remaining buttons, sliders and knobs are typically assigned to various effects and synthesis parameters.

TRANSCOPE Buttons

The TRANSCOPE buttons can be used to change the tuning of notes played on the PC4 keyboard in semitones (also known as half steps). This is a convenient way to change the key of a song without learning to play it in a different key.

The current transpose amount is shown in the top line of the display. Press both TRANSCOPE buttons simultaneously to reset the transposition to 0.

The TRANSCOPE buttons also transpose MIDI notes sent to the USB and MIDI Out ports.

PITCH WHEEL

Use the PITCH WHEEL to perform pitch bends. The Bend Up and Bend Down amount can be adjusted for each Zone in Multi Edit Mode.

MODULATION WHEEL

In Factory Multis, the MODULATION WHEEL button will typically control a layer volume or an effect amount. The name and value of the current assignment for each Zone is shown in the Display when the wheel is moved. The assignment can be adjusted for each Zone in Multi Edit Mode.

VARIATION Button

In Factory Multis, the VARIATION button will typically enable layer an effect. The name of the current assignment for each Zone is shown in the Display when the button is pressed. The VARIATION button can be enabled or disabled for each Zone in Multi Edit Mode.

ARPEGGIATOR Section

The Arpeggiator takes note input from the keyboard and outputs a rhythmic and/or melodic pattern of MIDI notes. The Arpeggiator can affect both the internal Programs and external MIDI instruments. The Arpeggiator settings for each Zone can be adjusted in Multi Edit Mode.

Use the ARP button to turn on and off the Arpeggiator in each Zone. Each Zone in a Multi has an arpeggiator, allowing up to 16 simultaneous arpeggiations.

Use the LATCH button to latch the arpeggiator, which allows notes to continue arpeggiating after keys have been released.

TEMPO Section

Use the TEMPO section to set the tempo of the current multi. The Multi tempo typically sets the tempo of the Arpeggiator, riffs, and the rate of tempo synced LFOs and FX (such as Delay). To set the tempo press the TAP button a few times at the desired rate, or use the TEMPO knob.

SW1 (SUSTAIN) and SW2 Pedals

The SW1 (SUSTAIN) pedal defaults to controlling sustain, which will sustain any note that is played while the pedal is pressed, for as long as the pedal is held.

For KB3 Organ Programs, the SW1 (SUSTAIN) pedal controls the Rotary Speaker speed, changing between fast and slow. The Display shows “KB3” when a Multi containing a KB3 Program is selected.

The SW2 pedal defaults to controlling Sostenuto, which will sustain notes from any keys that are being held when the pedal is pressed, for as long as the pedal is held.

The SW1 (SUSTAIN) and SW2 pedals can be enabled, disabled, or reassigned for each Zone in Multi Edit Mode. Because of this, the pedals may function differently for each Zone in each Multi.

Global Mode can be used to set pedal overrides, which can change the pedal assignments for all Multis.

CC1 (VOLUME) and CC2 Pedals

The CC1 (VOLUME) pedal defaults to control Program volume (pre-FX).

For KB3 Organ Programs, the CC (VOLUME) pedal controls organ swell. Organ swell is similar to Program volume, except volume can not be turned all the way down to silence. The Display shows “KB3” when a Multi containing a KB3 Program is selected.

The CC2 pedal typically controls FX such as wah.

The CC1 (VOLUME) and CC2 pedals can be enabled, disabled, or reassigned for each Zone in Multi Edit Mode. Because of this, the pedals may function differently for each Zone in each Multi.

The Split and Layer Soft Buttons

The Split and Layer functions have identical parameters, but produce different results.

The Split function allows you to quickly create a Multi such that keys in one range of the keyboard produce different sounds than another range.

The Layer function allows you to layer Programs and Multis such that more than one instrument sound can be produced by playing one key.

The Split and Layer functions allow you to quickly create Multis without using Multi Edit Mode to configure Zone key ranges, Programs, and volumes. After creating and saving a Split or Layer Multi, you can edit additional Multi parameters in Multi Edit mode.

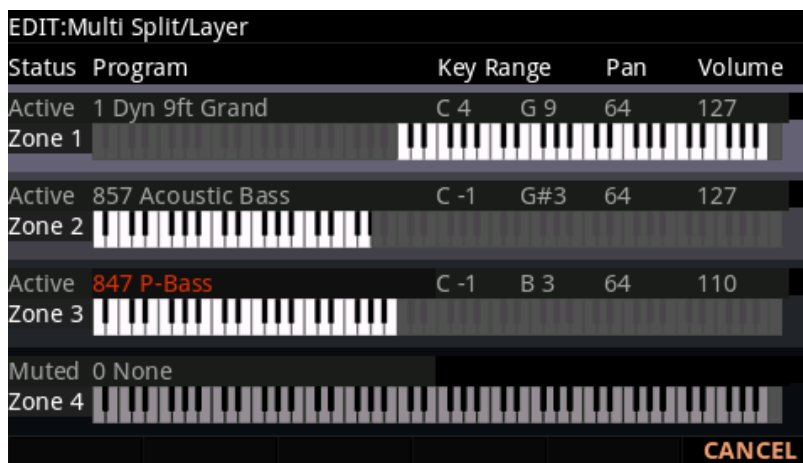

The Split Function

When you create a Split in Multi Mode, you are activating a new Zone in the current Multi. The previously active Zones will keep their previously assigned keyboard ranges. After this you can choose a Program that will be used in the left hand as a Split Program for the newly activated Zone.

Follow these steps to create a Split:

1. In Multi Mode, select a Multi.
2. Press the SPLIT soft button.
3. On the "Split" Page, a new Zone is selected with a default Bass Program selected for the left hand of the Split. Use the ALPHA WHEEL or CATEGORY buttons to select a different Program for the left hand of the Split.
4. If desired you may wish to adjust additional Split parameters, described in [Split and Layer Parameters on page 2-7](#).

5. Press the SAVE button to save your Split as a Multi (See below for details on saving). After saving your Split Multi, you can edit additional Multi parameters in Multi Edit mode.

The Layer Function

When you create a Layer in Multi Mode, you are activating a new Zone in the current Multi. You can choose a Program that will be used as the new layered Zone.

Follow these steps to create a Layer:

1. In Multi Mode, select a Multi.
2. Press the LAYER soft button.
3. On the “Layer” Page, the new Zone is selected with a default layer Program selected. Use the ALPHA WHEEL or CATEGORY buttons to select a different Program for the new layered Zone.
4. If desired you may wish to adjust additional Layer parameters, described in [Split and Layer Parameters on page 2-7](#).
5. Press the SAVE button to save your Layer as a Multi (See below for details on saving). After saving your Layer Multi, you can edit additional Multi parameters in Multi Edit mode.

Split and Layer Parameters

Zone Status

Selecting Split or Layer makes a new Zone active. You can continue to activate additional Zones with the Stat parameter.

Program

The Program parameter for the first available Zone determines the Program for the left-hand side of the Split, also known as the “Split Program”. This parameter is selected by default when performing the Split function, and the default Split Program will be selected. Choose a Split Program using the Category buttons, the Alpha Wheel, the Previous/Next buttons, or enable the Keypad button and type an ID number followed by the Enter button.

Volume

Use the Volume parameter to change the volume of each Zone. To set a volume, use the Alpha Wheel, the Previous/Next buttons, or use the keypad function of the Category buttons to type a volume (0-127) followed by the Enter button.

Multi Mode

The Split and Layer Soft Buttons

A value of “None” will use the last volume value used by the Zone’s MIDI channel (often set by the expression pedal). A value of “None” can be entered by scrolling below 0, or by using the keypad function of the Category buttons to type negative 1 by pressing the small +/- button and then the 1 button, followed by the Enter button.

Key Range

You can adjust the boundary between the left and right hand Programs on the keyboard by adjusting the Key Range low and Key Range high parameters for each Zone. The keyboard display for each Zone shows a visual indication of the Key Range by dimming keys that are outside of the Key Range.

To change the Key Range of a Zone, use the cursor buttons to select the Key Range low or Key Range high parameters for one of the Zones. Key Range low and Key Range high are the left and right parameters, respectively, below the Key Range label. With one of these parameters selected, set the Key Range by using the Alpha Wheel, the Previous/Next buttons, or use the keypad function of the Category buttons to type a key number (0-127) followed by the Enter button. With Key Range low or Key Range high selected, the value can also be changed by holding the Enter button, then pressing the desired key.

Pan

To change the panning of a Zone (left/right stereo placement), use the cursor buttons to select the Pan parameter for one of the Zones. To set a Pan value, use the Alpha Wheel, the Previous/Next buttons, or use the keypad function of the Category buttons to type a pan value (0-127) followed by the Enter button. A value of 0 is full left, 64 is center, and 127 is full right. Other values will move the stereo placement in between these positions.

A value of “None” will use the last pan value used by the Zone’s MIDI channel. A value of “None” can be entered by scrolling below 0, or by using the keypad function of the Category buttons to type negative 1 by pressing the +/- button and then the 1 button, followed by the Enter button.

Saving a Split or Layer

After setting the Split parameters, press the Save button to the left of the display to begin the saving process. See [Save User Multis](#) below for details on saving.

Once you have saved your Split or Layer, you can continue to add Zones to the Multi until you reach the maximum number of active Zones. Also, once you have saved your Split, you can use Multi Edit Mode to edit controller assignments (like effects controls and sustain pedal per Zone), transposition per Zone, and other Multi parameters. See [Multi Edit Mode on page 7-1](#) for details.

Save User Multis

Press the Save button to view the Save Dialog, which allows you to save a Split or Layer Multi as a User Multi, or to save a Multi with its current Zone Mute button status. To save the changed state of Multi controllers which have other assignments, you must set an entry value for each controller on the Multi Edit Mode Controls Page. See [CONTROLS Page on page 7-13](#) for details.

The Save Dialog allows you to choose an ID number to that will be associated with the Multi you are saving. When viewing the Save Dialog, you can quickly save the Multi to the displayed ID number by pressing the Save button again.

Changing ID Numbers

The display shows the first available ID number and the current Multi name. User Multis can be saved to ID numbers from 4096 to 8191.

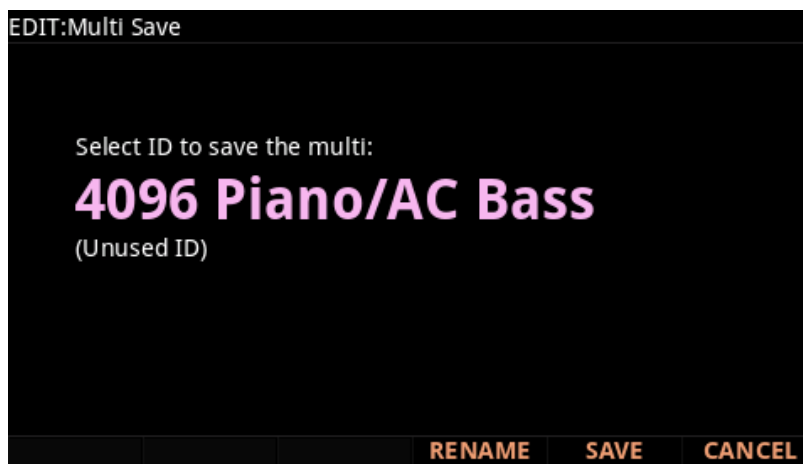

If you are saving a Multi that has not been previously edited, the next available unused ID number will be selected.

If you are saving a previously edited User Multi, the ID number that the Multi was last saved with will be selected.

Press the Previous and Next buttons simultaneously to toggle between selecting the ID number that the Multi was last saved with and the next available unused ID number.

To change the ID number, turn the Alpha Wheel or use the Previous/Next buttons to select the new ID number. The label underneath indicates if it is an “Unused ID”. You can also use the keypad function of the Category buttons to type an ID number, followed by pressing the Enter button

Multi Mode

Save User Multis

If you select an ID currently in use, the display will notify you that by saving you will “replace” the Multi currently in that location. Confirm overwriting of the existing Multi by pressing Save, or choose a different ID.

Naming a User Multi

To rename the Multi, first press the RENAME soft button. The display shows the current Multi name.

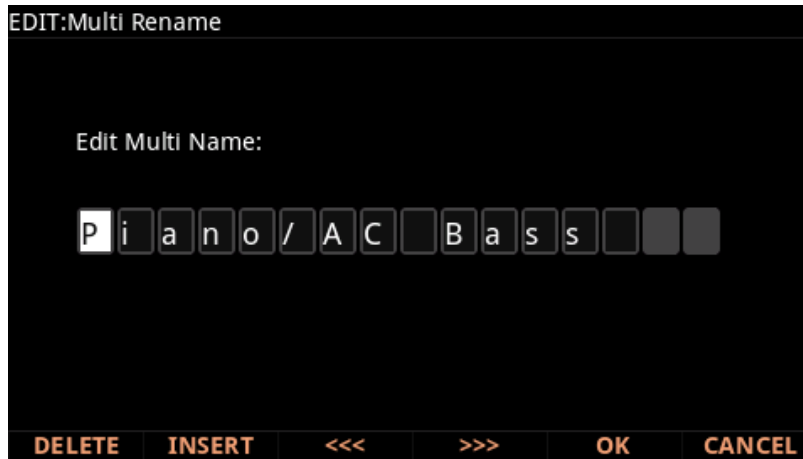

Use the Category buttons, Alpha Wheel or Previous/Next buttons to change each character.

Use the Left/Right cursor buttons or <<< >>> soft buttons to move the cursor.

Press the +/- button to switch between upper and lower case characters.

Use the Insert button to insert a blank space. The selected character and all characters to the right will move one space to the right.

Use the Delete button to delete the current character (all the characters to the right will move one space to the left).

Saving a User Multi

Press the Save button or Save soft button to complete the saving process, or press the Cancel soft button to exit without saving. After successfully saving, the Multi will be selected in Multi Mode. To find the Multi again later, press the User button and scroll to the Multi ID. You can also type the Multi ID number, then press the Enter button.

Recording A Multi To Song Mode

The MIDI output of a Multi can be recorded to a song in Song mode. Each MIDI channel that is output from a Multi is recorded into each track of a song (if the tracks have corresponding MIDI channels). Programs from each zone of your Multi are automatically assigned to tracks in Song mode. Follow these steps for proper recording of a new song from a Multi:

1. Press the Global Mode button to go to the Global Main 1 page, and make sure the Song Rechannel parameter is set to Auto. When recording, this will enable recording on all song tracks/channels.
2. Enter Song mode by pressing the SONG mode button.
3. On the Song mode MAIN page, select 1 New Song in the Song field by entering 1 on the alphanumeric pad and pressing the Enter button. This loads a default empty song.
4. Press the Multi Mode button to enter Multi Mode and choose the desired Multi.
5. Enter a tempo by tapping the Tap Tempo button or using the Tempo knob.
6. Press the RECORD button and then the PLAY/PAUSE button to begin recording. The metronome will count off 1 bar and then recording will begin (you can set metronome and other recording settings in Song mode).
7. Press the PLAY/PAUSE button to stop recording. You will see a Save New Recording dialog where you can save or discard the performance you just recorded. To retry your recording, press the DISCARD soft button, then go back to step 6.
8. On the Save New Recording dialog, press the SAVE button to begin saving the song. Select an ID to save the song, rename the song if desired, then press SAVE again to complete saving the song. After saving your song, you will be returned to the Multi mode MAIN page. If you wish, you can now record additional overdub performances by going back to step 6. You can also go to Song Mode to listen to the song or perform additional recording or edits while in Song Mode.

Additional Editing in Song Mode

You can go to Song Mode and edit the song you recorded just as you would with any other song (see [Song Mode on page 8-1](#) for details). Each program from each zone in your Multi is automatically assigned to a track (change the Rec Track parameter in order to select and record to a single track). You can also continue to record from Multi mode by going back to step 4, above. Remember to set the tempo (step 5 above) before recording, if your Multi is saved with a different tempo than the song.

Notes About Recording A Multi To Song Mode



Tempo: The tempo of a Multi is set on the Multi COMMON page. If you plan to record a song from the same Multi several times, it is convenient to set your desired tempo on the COMMON page and save it with your Multi. By doing this, you will not need to reset your Multi tempo to the desired song tempo every time you load your Multi.

Riffs: If you are using Riffs in your Multi, do the following to make each Riff play at your Multi's tempo (which also becomes your song's tempo). For each zone that has a riff, go to the Multi Edit RIFF page and set the **Riff Tempo** parameter to **Multi**. Remember to save changes to your Multi when exiting the Multi Editor.

Effects: When recording a Multi into Song mode, the song will not retain the Aux or Master effects settings of your Multi. If you would like your song to use the same effects as your Multi, copy the settings of your Multi's FX page to the FX page in your song. Alternatively, playing your song from Multi mode will allow you to hear the effects. To do this, load your song, press the **Multi** Mode button to enter Multi mode and choose your Multi, then press the **PLAY** soft button. This will play your song from Multi mode, and the effects will be intact.

Mono Pressure: When recording a Multi to Song mode with **Mult** selected for **Rec Track** in Song mode, you may notice that every track has recorded Mono Pressure messages, even if there is nothing else recorded on a track. This is the result of mono pressure messages being transmitted from the keyboard, even if they are not controlling anything in the selected programs. If this bothers you, set the **MonoPress** parameter to **Off** on the Song Event Filter Recording page (see [The FILTER Page on page 8-20](#)). This will prevent Mono Pressure messages from being recorded to any track. Alternatively, you can erase Mono Pressure messages from specific tracks after recording. To do this, go to the Song mode Track page (see [The TRACK Page on page 8-23](#)). On the Track page, use the CHANNEL/LAYER/ZONE/TRACK buttons to choose the track to edit (visible in the **Track** field at the top right corner of the display.) Set the **Function** parameter to **Erase** and the **Events** parameter to **MonoPress**. Use the **From** and **To** fields to select the entire length of your song, and press the **Go** soft button to erase Mono Pressure messages from the selected track. Repeat this for each desired track. You can also choose **All** for the **Track** parameter to erase Mono Pressure messages from all tracks.

Controller Messages: When recording a Multi to Song mode with **Mult** selected for **Rec Track** in Song mode, you may often be recording more controller messages than you realize. This can happen because multiple Multi zones often respond to the same physical controllers. This is likely to be the case when you use a Multi created by duplicating zones and do not change the controller destination assignments for each new zone. Often this is the desired behavior, such as when using zones to create layers. For example, if zone one sends pitch bend messages from the pitch wheel, and you duplicate this zone to create a layered zone two, you will likely want the zone two to send the same messages from the pitch wheel. This way the pitch of these layered zones will bend simultaneously when using the pitch wheel. But say for example that you also have a zone three with a different key range than zones one and two, but which sends the same messages from the pitch wheel. While playing and

recording your Multi, the function of the pitch wheel will be obvious, but some confusion can arise when you have recorded your Multi and you proceed to record more tracks in Song mode. Because you have recorded with **Mult** selected for **Rec Track**, the track for zone three will have pitch bend messages recorded wherever zones one and two have bend messages, even if zone three was not playing any notes at that time. For example, lets say zones one and two were bending during bar 1. If you want to separately record zone three during bars 1 and 2, you will probably want to delete the existing bend messages from zone three's track. You can do this from the Song mode Track page (*see [The TRACK Page on page 8-23](#), and an example of its use in the Mono Pressure section, above*). Alternatively, if there is nothing to preserve on the track for zone three, you can record it with the song **Mode** parameter set to **Erase**, which will erase any existing events on the track during the time that you record. Just remember to change the **Rec Track** parameter to a single track number in order to record only to a single track.

Multi Mode

Recording A Multi To Song Mode

Chapter 7

Multi Edit Mode

Multi Edit Mode allows you to edit and customize Multis. Any Multi can be edited in Multi Edit Mode and saved to a User ID.

To enter Multi Edit Mode, first press the MULTI Mode button to enter Multi Mode, then press the EDIT button.

Navigation

Press the soft buttons at the bottom of the screen to navigate to each page, or to perform the labeled function.

Use the cursor buttons to select each parameter, and the PREVIOUS/NEXT buttons, Alpha Wheel, or CATEGORY buttons to change each value.

When certain parameters are selected, additional editor pages or functions can be accessed by pressing the EDIT button. The EDIT icon appears at the top of the screen when the EDIT button can be used.

See the following sections for details on navigating, selecting parameters and changing values.

Soft Buttons in the Multi Editor

Press the soft buttons at the bottom of the screen to navigate to each page, or to perform the labeled function.

Press the MORE soft buttons to view more sets of soft buttons.

See the rest of this chapter for details on each of the Multi Edit Mode pages.

See [“Soft Buttons in the Multi Editor” on page 7-1](#) for details on soft button functions in Multi Edit Mode pages.

Zones

Use the CHANNEL/LAYER/ZONE/TRACK buttons to change the current Zone. Most parameters apply only to the currently selected Zone, which will be shown in the top right corner of the display. Some parameters on the CONTROLS page apply to all Zones. When a CONTROLS page parameter is selected which applies to all Zones, “All Zones” will be displayed in the top right corner of the display. Parameters on the FX Page, COMMON Page and ARP Page apply to all Zones.

The EDIT Button in the Multi Editor

When certain parameters are selected, additional editor pages can be accessed by pressing the EDIT button. The EDIT icon appears at the top of the screen when the EDIT button can be used.

Press the EDIT button to enter sub editors when the following fields are selected:

- Programs on the OVERVIEW page
- FX Chains on the FX and AUDIO IN pages
- Patterns on the ARP page (Shift, Velocity, and Duration)

Assign

Assign is the secondary function of the Enter button. You can use the Assign function to quickly select parameters or set values for parameters by holding the Enter button while moving PC4 controllers (Knobs, Sliders, Buttons, Keys, Wheels, and Pedals).

Parameters that can use the Assign function are indicated by showing the Assign symbol in the top right corner of the display when selected.

Select a Key Range

When the OVERVIEW Page Key Range fields are selected, hold the Enter button and press a keyboard key to set the low or high Key Range.

Select a Physical Controller

When the CONTROLS Page Controller field is selected, hold the Enter button and move a physical controller to select the moved controller.

Select a Controller Destination

When a CONTROLS Page Destination field is selected, hold the Enter button and move a controller to select the default destination for that controller. This is an easy way to assign Multi Controllers to their Program Mode assignments.

Select a Controller Value

When a CONTROLS Page Entry Position, Exit Value, On Value or Off Value field is selected, hold the Enter button and move a continuous controller to select a value.

Select a Key

When a CONTROLS Page Key or Key1-8 field is selected, hold the Enter button and press a keyboard key to select a key.

Assign an FX Mod Override

When an FX Page Mod Override field is selected, hold the Enter button and move a physical controller to assign the moved controller, or

When an FX Page Mod Override field is selected, hold the Enter button and press one of the keyboard keys. Each of the 88 keys will select one of the available control sources.

OVERVIEW Page

The Overview Page shows basic parameters for up to 4 Zones at a time. Use the CHANNEL/LAYER/ZONE/TRACK buttons to view additional Zones.

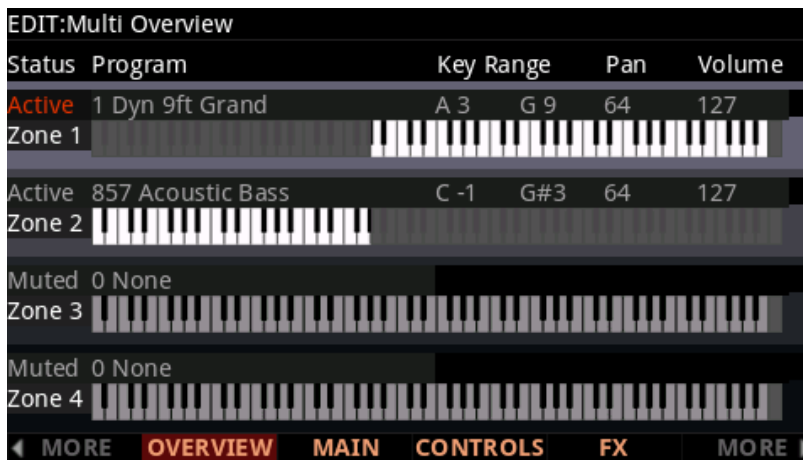

Status

The Status parameter determines whether the currently selected Zone is Active or Muted.

Program

The Program parameter determines the Program for the currently selected Zone.

Multi Edit Mode

OVERVIEW Page

When the Program field is selected, press the Previous and Next buttons simultaneously to jump to the first Program of each Category, as well as the Category Default Program of each Category.



Note: Only one KB3 Organ program can be loaded at a time, using the designated KB3 channel (for details see [“KB3 Channel” on page 7-40](#)). If a second KB3 program is selected on a Zone that is not using the KB3 channel, a red and white warning symbol will be displayed to the right of the Program name (see below), and the previously selected non-KB3 program will be used for the Zone.

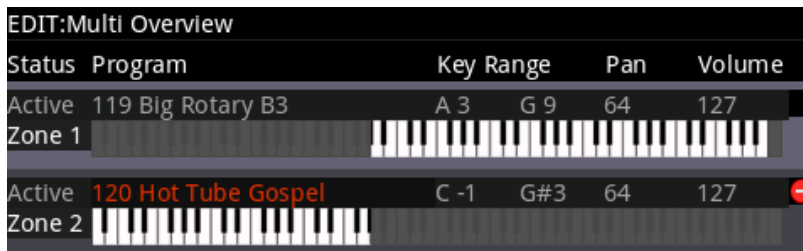

Key Range

The left Key Range field sets the lowest key of the Zone, the right Key Range field sets the highest key of the Zone.

You can also set the lowest key higher than the highest key and vice versa. This allows you to split a Zone into two areas where the lowest and highest keys now define the region that the Zone does not play on.

Pan

The Pan parameter determines the left/right panning of the currently selected Zone. You can set this parameter to any pan setting from None, 0 (full left), 64 (center), to 127 (full right).

None can be entered as -1 on the keypad, which will keep the last pan setting used by the Zone's MIDI channel.

Volume

The Volume parameter determines the Volume of the currently selected Zone. You can set this parameter to any volume setting from None, 0 to 127.

None can be entered as -1 on the keypad, which will keep the last volume setting used by the Zone's MIDI channel.

MAIN Page

The Main Page shows various settings for the currently selected Zone. The top right hand corner of the display shows the currently selected Zone number. Use the CHANNEL/LAYER/ZONE/TRACK buttons to select a Zone.

EDIT:Multi Main		chzn Zone:1/4	
Transpose	0 ST	Velocity Mode	Traditional
Notemap	Linear	Velocity Scale	100%
Destination	USB+MIDI+LOCAL	Velocity Offset	0
Output	Auto	Velocity Curve	Linear
Channel	1	Low Velocity	1
Bank Mode	Ctl 0/32	High Velocity	127
Midi Bank	0	Input Channel	None
Midi Program	1	Aux Bend Up ST	12 ST
EntryProgChng	On	Aux Bend Dwn ST	12 ST
Bend Up ST	2 ST	Bend Up CT	0 ct
Bend Down ST	2 ST	Bend Down CT	0 ct
Zone Name	Using Prog Name		
◀ MORE		OVERVIEW	MAIN
		CONTROLS	FX
			MORE ▶

Transpose

The Transpose parameter determines the transposition for the currently selected Zone. You can set this to any value from -128 semitones to 127 semitones.

Note Map

Note Map allows you to arrange the notes of a Zone across the keyboard in different configurations. See below for details on each of the Note Map settings:

Off

With Note Map set to Off, keys in the Zone will not play notes. This can be useful when controlling external MIDI equipment, you may wish to send controller values without notes.

Linear

With Note Map set to Linear, all keys produce notes as played. This is the default setting.

Inverse

With Note Map set to Inverse, the keyboard plays upside-down, with the highest note being played by key A0 and the lowest note being played by key C9.

Constant

With Note Map set to Constant, all of the keys on the keyboard will play the same note (C4). Use the Transpose parameter to change the note that is played. This is useful for layering a percussion sound from a particular key to play with every note of another zone. For example, playing a ride cymbal with every note in a bass line.

Alternating (1 of 2 through 4 of 4)

The Note Map parameter includes various alternating note maps (1 of 2 through 4 of 4). If you are using two or more MIDI devices (including the PC4), you can expand polyphony by assigning each zone to a different alternating note map.

For example, if you have two PC4s, you can assign two zones to each play the same program on a different PC4, thereby doubling polyphony. Follow these steps:

1. Set Zone 1 to Note Map 1 of 2; now the zone plays on every second key, starting on C, but won't play on any other keys.
2. Set Zone 2 to Note Map 2 of 2, and this zone will play on every second key, starting on C#, thus covering the remaining keys. Three and four-zone alternating note maps work the same way, but cause each zone to play only on every third and every fourth key, respectively.

Destination

The Destination parameter determines whether MIDI data generated by the keyboard and physical controllers of the currently selected Zone is sent to a PC4 Program, through the MIDI Out/USB ports, or all three. You can set this parameter to any of the eight combinations for the three destinations for this parameter.

Note that Zone MIDI data is also affected by the Global Mode Destination parameter (see [page 9-23](#)). For example if Global Mode Destination is set to MIDI, and Zone Destination is set to Local + MIDI, transmission will be limited to MIDI only.

Output

Use the Out parameter to set the rear panel audio outputs used for each zone of the current Multi. This parameter determines the output settings for the main program signal and insert effects of each zone

A setting of Auto will make that zone output audio based on the settings for the program used by that zone. Program output settings are set in the Program Editor using the Output parameter on the FX page.

A setting of A will output Zone audio to the “A” Balanced Analog Outputs.

A setting of B will output Zone audio to the “B” Balanced Analog Outputs.

Channel

The Channel parameter determines the MIDI transmit and receive channel for the currently selected Zone. You can set this parameter to any of the 16 MIDI channels (1-16).

You can assign different Zones to the same channel, but only one Program can be loaded in a channel at a particular time. The Program loaded will be whichever program change message is received last.

Bank Mode

The Bank Mode parameter determines the controller number used for transmitting MIDI Bank change messages. When sending Bank change messages to external MIDI equipment, you may have to adjust this setting depending on which controller numbers the equipment responds to. Most equipment responds to controller numbers 0, 32, or both. The Kurzweil K2600 it responds to controller 32, but is limited to 100 programs per bank.

You can set this parameter to any of the following:

None	MIDI Bank change messages are disabled.
Ctl0	MIDI Bank change messages are sent with controller number 0.
Ctl32	MIDI Bank change messages are sent with controller number 32.
Ctl0/32	MIDI Bank change messages are sent with both controller numbers 0 and 32.
K2600	MIDI Bank change messages are sent with controller number 32. (K2600 Program numbers 0-99.)

Midi Bank

The MIDI Bank parameter determines the MIDI Bank change message that the currently selected Zone sends when the Multi is loaded. You can set this parameter to a MIDI Bank change message from 0 to 16383.

When using the PC4 as a MIDI controller, sending a MIDI Bank change message (along with a MIDI Program change message) when a Multi is loaded ensures that the Program loaded on the other sound modules in your MIDI chain is the Program that you want.

For example, if you've configured a Multi to work in a specific way with Program 32 in Bank 5 of a connected sound module, then set MIDI Bank to 5 and MIDI Program to 32. This way, whenever you load this Multi, the sound module will automatically load Program 32 in Bank 5. Pressing both Previous & Next buttons simultaneously will set this parameter to the Bank number of the currently selected Local Program.



Note: When you change the Program parameter, the MIDI Bank and MIDI Program

parameters will automatically change to match the Bank and Program numbers of the Program that you select for Local Program. For example, if you choose Program 178, then MIDI Bank will change to 1 and MIDI Program will change to 50.

Midi Program

The MIDI Program parameter determines the MIDI Program change message that the currently selected Zone sends when the Multi is loaded. You can set this parameter to a MIDI Program change message from 0 to 127.

When using the PC4 as a MIDI controller, sending a MIDI Program change message (along with a MIDI bank change message) when a Multi is loaded ensures that the Program loaded on the other sound modules in your MIDI chain is the Program that you want. For example, if you've configured a Multi to work in a specific way with Program 32 in Bank 5 of a connected sound module, then set MIDI Bank to 5 and MIDI Program to 32. This way, whenever you load this Multi, the sound module will automatically load Program 32 in Bank 5.



Note: When you change the Program parameter, the MIDI Bank and MIDI Program parameters will automatically change to match the Bank and Program numbers of the Program that you select for Local Program. For example, if you choose Program 178, then MIDI Bank will change to 1 and MIDI Program will change to 50.

EntryProgChng

The Entry Program Change parameter determines whether or not the currently selected Zone will send a MIDI Program change message when the Multi is loaded. You can set this parameter to either Off or On. When set to On, the Zone will send a MIDI Program change message with the Program specified for the MIDI Program parameter.

Bend Up / Down ST & Bend Up / Down CT

Bend Up ST and Bend Down ST sends a bend range message to an internal program or a MIDI device, telling it how to define subsequent pitch bend messages. You can set this parameter to any value between 0 semitones and 127 semitones, or to Prog, which uses the Bend Range Up / Down of the currently selected Program for the Zone. The value can be entered numerically, and entering -1 will select Prog. (value that the Program would use in Program Mode).

Bend Up CT and Bend Down CT lets you fine tune the value for Bend Up ST & Bend Down ST (semitones). 100 cents equals one semitone, or one half step; you can set this parameter anywhere between 0 and 100 cents.

Aux Bend Up / Dwn ST

Use the Aux Bend Up / Dwn ST parameters to set the Aux Pitch Bend Up and Down ranges in semitones. Aux Pitch Bend is controlled by controller destination 21, the default destination for the Ribbon Controller.

Velocity Mode

The Velocity Mode parameter determines the method that the PC4 maps the keyboard's strike velocity to MIDI velocity. Set to "Traditional" the keyboard's velocity will translate to a MIDI velocity depending on how hard you strike it. With a setting of "Fixed", the velocity is set to a pre-determined value regardless of how hard or soft the keyboard is played.

A setting of "Fixed" will remove some of the other Velocity settings in the MAIN page and replace it with a parameter called Velocity that has a range of values from 0 to 127.

Velocity Scale

The Velocity Scale parameter lets you amplify or diminish velocity response from -300% to 300%. Normal response is 100%. Higher values make the keyboard more sensitive (you don't need to play as hard to get higher MIDI velocities) while lower values make it less sensitive (playing harder doesn't change MIDI velocity as much). You can also set the scale to a negative number, in which case the velocity response is turned upside-down: playing harder produces a softer sound and vice versa. This is useful for creating velocity-based crossfades between zones.

Velocity Offset

The Velocity Offset parameter also changes the velocity response, but in a more direct way, by adding or subtracting a constant to the key velocity.

For example, if this is set to 25 (assuming a scale of 100%), then 25 is added to the velocity of every keystroke, usually making the sound that much louder. The softest possible keystroke will have a value of 25, while a keystroke with a velocity of 102 will produce the same sound as a note with a velocity of 127 ($102+25=127$). Negative values diminish the response: a setting of -25 means the loudest velocity available will be 102, while any keystroke 25 or below will produce a velocity of 1 (a velocity value of zero has a special meaning in MIDI and cannot be used for Note Ons).

You can think of Scale as being a proportional change to the velocity, while Offset is a linear change. The maximum values for Offset are ± 127 .

Offset and Scale work together. If scaling takes the velocity out of the ballpark — for example, you want to set it to 300% but that puts all of your notes at maximum velocity — using a negative offset, say around -60, can make it possible to still play at different volumes, although your curve will still be a lot steeper than normal. If you use a negative scaling, then you must use an offset: otherwise all of your velocities will end up as zeroes (well, ones actually, since a MIDI note-on with velocity zero is interpreted by some modules as a note-off message). So to get true inverse scaling (that is, minus 100%), you must set an offset of 127 to get the full range of velocities. Setting the offset to 127 and the scale to -100% (which is the same as the reverse linear curve).



Note: Offset and Scale only affect incoming MIDI velocities; these parameters don't change Velocity Tracking in the programs themselves. Therefore, programs which have low VelTrk values may respond only subtly to Offset and Scale, or not at all.

Velocity Curve

The Velocity Curve parameter lets you taper the velocity response. The default setting is **Linear**, which means that the output velocity changes directly proportionally to the played velocity.

Expand produces a curve that is less steep than the linear curve at keystrike velocities below 64, and steeper than the linear curve at keystrike velocities above 64. In other words, when you're playing softly, you'll notice velocity differences less than with a linear curve, while when you're playing hard, you'll notice velocity differences more.

Compress produces a velocity curve that is the opposite of the expanded curve—that is, you'll notice velocity differences more when you're playing softly than when you're playing hard.

Crossfade is designed to be used in tandem with the Reverse Crossfade curve, enabling you to perform smooth crossfades between different programs.

Bump tapers velocity response to resemble a bell curve, so that notes are loudest when your keystrike velocity is 64. Notes get softer as the keystrike velocity approaches 0 or 127.

The next four velocity curves are Reverse Linear (**Rvrs Linear**), Reverse Expand (**Rvrs Expand**), Reverse Compress (**Rvrs Compress**), and Reverse Crossfade (**Rvrs Crossfade**). These taper velocity in reverse of the five curves we just covered. For example, Reverse Linear's response is such that striking a key harder will produce a lower volume, striking it softer will produce a higher volume, and so on. This provides a convenient way to achieve negative scaling, by letting you set one parameter instead of two.

Low Velocity, High Velocity

Low Velocity and High Velocity set the minimum and maximum velocity limits that the current Zone transmits.

A keystroke in the current Zone whose velocity — *after* it has been scaled and offset — is below the minimum does not generate a Note On. Neither does a keystroke whose velocity after processing is above the maximum. These parameters are useful for “velocity switching”—having a key play different sounds depending on how hard you strike it.

The values can be anywhere from 1 to 127. As with other parameters, zones can overlap or be totally discrete, or be identical. Usually, Low Velocity will have a smaller value than High Velocity, but you may also create a gap in velocity response, by setting High Velocity to a lower value than Low Velocity.

Input Channel

The Input Channel allows remapping of incoming MIDI data through specified Zones. Here’s how it works:

In Multi mode, an external MIDI device (such as a keyboard or sequencer) will play notes of a single program by default (if the Global mode Local Keyboard Channel parameter is set to None, see [Local Kbd Chan \(Local Keyboard Channel\) on page 9-25](#) for details.) The played program will be on a Zone that has a Channel parameter (on the MAIN page) which matches the channel on which the external MIDI device is transmitting. (If no Zone’s Channel parameter matches, the external device will play notes of the last program that was using that channel in Program Mode or from a previously loaded Multi.)

When the Program of a Multi Zone is played from an external MIDI device, Multi MIDI parameters (most noticeably key range and transposition) will not be applied. If you want these parameters applied, set the Input Channel parameter to match the channel on which the external MIDI device is transmitting. See the Input Channel Settings section below for details on setting an Input Channel. (To play the entire Multi from an external MIDI device, see [Local Kbd Chan \(Local Keyboard Channel\) on page 9-25](#).) When Local Keyboard Channel is set to something other than None, the Input Channel parameter has no effect and will appear in parentheses.

Input Channel basically has the same effect as Local Keyboard Channel, except you can choose to play only one or some Multi Zones from an external device, instead of all Zones. To play more than one Zone from an external device, set each desired Zone’s Input Channel parameter to match the channel on which the external MIDI device is transmitting.

Input Channel Settings

When setting a MIDI channel number for the Input Channel parameter, channel 1 for example, you can choose “1 L+M” or “1 M” (scroll past “16 L+M” to see all the choices.) A channel number with a setting of “L+M” indicates that the zone will be playable from the PC4 keyboard (L for Local) and from the external MIDI controller (M for MIDI.) A channel number with a setting of “M” indicates that the zone will be playable only from the

Multi Edit Mode

MAIN Page

external MIDI controller, and not from the PC4 keyboard. You can also choose “Any L+M” or “Any M” for the Input Channel setting. “Any L+M” and “Any M” will make the zone receive MIDI on any channel that an external device is transmitting. This is useful if you are using a single external MIDI controller and are not sure which channel it is transmitting on.

Zone Name

Use the Zone Name parameter to give the Zone a name that can be viewed when Multi Mode is set to show Zone Info. By default the Zone’s Program name is used as the Zone name.

To edit the Zone name, select the Zone Name field and press the EDIT button to enter the Zone Name editor. Use the Navigation buttons and soft buttons to change the Zone name. Press OK to save the new Zone name, or CANCEL to return to the previous page.

For details on showing Zone Info in Multi Mode, see [“Show Zone Info” on page 9-7](#).

CONTROLS Page

Use the Controllers Page to adjust controller settings for each Zone. The top right hand corner of the display shows the currently selected Zone number. Use the CHANNEL/LAYER/ZONE/TRACK buttons to select a Zone.



The PC4 has 2 types of controllers, switch controllers and continuous controllers. Each type of controller has different parameters, see each section below for details.

Controlling Program Parameters from Multi Mode

To assign a Multi controller to a Program parameter, use the Destination field. In the Destination list, destinations that are assigned to parameters for the Program of the current Zone will show the Program Parameter name next to the Destination number. Select one of these destinations to control an assigned Program parameter.

You can also select the Destination field, hold the ENTER button, then move the controller that was assigned in Program Mode.

Switch Controllers

This section describes parameters for the following switch controllers:

- SW pedals 1 and 2
- VARIATION button
- ARP button
- LATCH button
- CONTROL buttons 1-9
- Key1-Key12

Multi Edit Mode

CONTROLS Page

Controller

Use the Controller field to select a controller for the currently selected Zone.

When the Controller field is selected, you can select a controller by using the ALPHA WHEEL, PREVIOUS/NEXT buttons, or by holding the ENTER button and moving a controller.

If a pedal is selected which has a pedal override enabled in Global mode, a message “Global Pedal Override is enabled” will display when that pedal is viewed to remind you that the Global mode pedal override settings are being used instead of the Multi mode pedal settings.

Mode

Switch Controllers can be set to the following modes: Off, MIDI CC, or Chord.

When Mode is set to Off, the controller is disabled for this zone.

When Mode is set to MIDI CC, the controller can send MIDI control messages.

When Mode is set to Chord, the controller can play a chord containing up to 8 notes.



Note: When Controller is set to ArpOn/Off or ArpLatch, the Mode parameter can not be set to Chord.

Type

Use the Type parameter to set a switch controller to Momentary or Toggled. This parameter affects the selected switch controller for all Zones.

When Type is set to Momentary, the switch controller sends its “On Value” when pressed, and its “Off Value” when released.

When Type is set to Toggled, the switch controller alternates between sending its “On Value” or “Off Value” each time it is pressed. No value is sent when the controller is released.

Destination

Use the Destination field to select a parameter to control.

Destinations 0-127 are MIDI continuous controller messages (CC numbers), which can be used to control PC4 Program parameters, or external MIDI gear.

CC numbers that can be assigned to Program parameters will show the parameter name next to the CC number. These CC numbers will control the Program in the current Zone.

Destinations 128 and greater can be used to control PC4 Program and Multi functions. For details see [“The Controller Destination List” on page 7-20](#).



Note: When Controller is set to ArpOn/Off or ArpLatch, the Destination parameter can only be set to Arp On/Off or Latch destinations.

On Value

The On Value is the MIDI value sent when a switch controller is set to On. You can set this parameter to any number between 0 and 127, or to None.

Off Value

The Off Value is the MIDI value sent when a switch controller is set to Off. You can set this parameter to any number between 0 and 127, or to None.

Entry State

The Entry State parameter determines the state of a switch controller when the current Multi is loaded. You can set this parameter to None, On, or Off. This parameter affects the selected switch controller for all Zones.

If Entry State is set to None, then when you load the current Multi, the switch controller state will not change.

Exit State

The Exit State parameter determines the state of a switch controller when the current Multi is exited. You can set this parameter to None, On, or Off. This parameter affects the selected switch controller for all Zones.

If Exit State is set to None, then when you leave the current Multi by selecting another Multi or Program, the switch controller state will not change.

Key1-Key8

When a switch controller Mode is set to “Chord”, the Key1-Key8 fields appear. Use the Key1-Key8 fields to select the notes of a chord to be played.

To select a note, select a Key1-Key8 field, hold the Enter button, then play the desired note on the keyboard. You can also change the note in the field by using the Alpha Wheel or PREVIOUS/NEXT buttons.

Velocity

When a switch controller Mode is set to “Chord”, the Velocity field appears.

If the Velocity parameter is set to 1-127, all notes in the Key1-Key8 fields will use the selected velocity value.

If the Velocity parameter is set to Auto, all notes in the Key1-Key8 fields will use the velocity set by the KeyVel Multi Destination (see KeyVel on [page 7-20](#)).

If the Controller parameter is set to a Key (Key1-Key12), and the Velocity field is set to Auto, the velocity all notes in the Key1-Key8 fields will be controlled by the velocity of the played key.

Multi Edit Mode

CONTROLS Page

If the Velocity parameter is set to Per Note, each note in the Key1-Key8 fields will use the velocity set by each of the 8 per note Velocity parameters.

Key

When the Controller parameter is set to a Key (Key1-Key12) and Mode is set to something other than “Off” the Key parameter appears.

Use the Key parameter to select which of the PC4’s Keys you wish to use as a switch controller. With the Key parameter selected, you can set a key by holding the Enter button and striking the desired key.

Do

When the Controller parameter is set to a Key (Key1-Key12) and Mode is set to something other than “Off” the Do parameter appears.

The Do parameter determines whether the key will play a note and perform a switch function, or whether the key will only perform a switch function. Set the Do parameter to “Both” to play a note and perform a switch function, or set it to “OnlySw” to only perform a switch function.

Continuous Controllers

This section describes parameters for the following continuous controllers:

- Modulation Wheel
- Pitch Wheel up and down
- CONTROL knobs 1-9
- CONTROL sliders 1-9
- CC pedals 1 and 2
- Pressure
- Ribbon

Controller

Use the Controller field to select a controller for the currently selected Zone.

When the Controller field is selected, you can select a controller by using the ALPHA WHEEL, PREVIOUS/NEXT buttons, or by holding the ENTER button and moving a controller.

If a pedal is selected which has a pedal override enabled in Global mode, a message “Global Pedal Override is enabled” will display when that pedal is viewed to remind you that the Global mode pedal override settings are being used instead of the Multi mode pedal settings.

Mode

Continuous Controllers can be set to the following modes: Off, or MIDI CC.

When Mode is set to Off, the controller is disabled for this zone.

When Mode is set to MIDI CC, the controller can send MIDI control messages.

Destination

Use the Destination field to select a parameter to control.

Destinations 0-127 are MIDI continuous controller messages (CC numbers), which can be used to control PC4 Program parameters, or external MIDI gear.

CC numbers that can be assigned to Program parameters will show the parameter name next to the CC number. These CC numbers will control the Program in the current Zone.

Destinations 128 and greater can be used to control PC4 Program and Multi functions. For details see [“The Controller Destination List” on page 7-20](#).

Scale

Use the Scale parameter to change the range of CC values sent by the controller (in combination with the Add and Curve parameters). The Scale parameter multiplies the CC values sent, changing the lowest and highest values sent by the controller. MIDI controllers are limited to sending values from 0-127, even if the Scale and Add parameters are set to produce values outside of this range.

By default, each continuous controller sends CC values 0-127, 0 at its lowest position, and 127 at its highest position. These values can be multiplied by the percent value of the Scale parameter in order to change the range of CC values. For example:

When when Scale is set to 100% (with Add set to 0 and Curve set to Linear), the controller sends CC values 0-127, 0 at its lowest position, and 127 at its highest position.

Scale values 1-99% make the controller send a smaller range of CC values, allowing for finer control of CC values. When Scale is set to 50% (with Add set to 0 and Curve set to Linear), the controller sends CC values 0-63, 0 at its lowest position, and 63 at its highest position.

Scale values 101-300% make the controller send a values 0-127 over a smaller range of controller positions, allowing for coarser control of CC values. When Scale is set to 200% (with Add set to 0 and Curve set to Linear), the controller sends CC values 0-127, 0 at its lowest position, and 127 at its middle position through its highest position.

When Scale is set to a negative number, the controller range is reversed. For example, when Scale is set to -100% (with Add set to 0 and Curve set to Linear), the controller sends CC values 127-0, 127 at its lowest position, and 0 at its highest position.

Add

Use the Add parameter to change the range of CC values sent by the controller (in combination with the Scale and Curve parameters). The Add parameter adds or subtracts from the CC values sent, changing the lowest and highest values sent by the controller. MIDI controllers are limited to sending values from 0-127, even if the Scale and Add parameters are set to produce values outside of this range.

By default, each continuous controller sends CC values 0-127, 0 at its lowest position, and 127 at its highest position. These values can be added to the value of the Add parameter in order to change the range of CC values. For example:

When when Add is set to 0 (with Scale set to 100% and Curve set to Linear), the controller sends CC values 0-127, 0 at its lowest position, and 127 at its highest position.

When when Add is set to 64 (with Scale set to 100% and Curve set to Linear), the controller sends CC values 64-127, 64 at its lowest position, and 127 at its middle position through its highest position.

When Scale is set to 50%, the controller sends CC values 0-63, 0 at its lowest position, and 63 at its highest position. With the Add parameter set to 64, the controller sends CC values 64-127, 64 at its lowest position, and 127 at its highest position.

When Scale is set to 200%, the controller sends CC values 0-127, 0 at its lowest position, and 127 at its middle position through its highest position. With the Add parameter set to 64, the controller sends CC values 64-127, 64 at its lowest position, and 127 at its middle position through its highest position.

Curve

The Curve parameter lets you apply different curves to the controller values, in order to make the controller more or less responsive in certain ranges of controller positions, or to distribute high and low values over different ranges of controller positions.

The **Linear** setting distributes CC values 0-127 evenly over the range of the controller, with 0 at its lowest position, and 127 at its highest position. This is the default setting.

The **Compress** settings distributes more of CC values 0-127 over the bottom half of the controller range, and fewer CC values over the top half of the controller range.

The **Expand** setting distributes more CC values 0-127 over the top half of the controller range, and fewer CC values over the bottom half of the controller range.

The **Crossfade** setting is designed to be used in combination with the Rvrs Crossfade setting, in order to smoothly crossfade between two programs on different Zones. Assign the Same controller to Destination 7 on two Zones, and select one of these curves for the controller on each Zone.

The **Bump** setting distributes CC values 0-127 to resemble a bell curve, with 0 at its lowest and highest positions, and 127 at its middle position

The Reverse settings (**Rvrs Linear**, **Rvrs Expand**, **Rvrs Compress**, and **Rvrs Crossfade**) distribute values in the reverse compared to the regular version of these settings. For example, the **Rvrs Linear** setting distributes CC values 0-127 evenly over the range of the controller, with 0 at its highest position, and 127 at its lowest position. .

Entry Position

The Entry Position parameter determines the position of a continuous controller when the current Multi is loaded. You can set this parameter to None, or 0-127.

This parameter affects the selected continuous controller for all Zones. The Scale, Add and curve parameters are applied to the Entry Position individually on each zone, allowing one controller to send different values to different zones, if desired.

If Entry Position is set to None, then when you load the current Multi, the continuous controller value will not change.

If the Global Mode “Multi Controllers” parameter is set to Pass Entry, and the physical controller is above or below the entry value when the Multi is selected, moving the controller will have no effect until it is moved past the entry position.

Exit Value

The Exit Value parameter determines the value of a continuous controller when the current Multi is exited. You can set this parameter to None, or 0-127. This parameter affects the selected continuous controller for all Zones.

If Exit Value is set to None, then when you leave the current Multi by selecting another Multi or Program, the continuous controller state will not change.

Configuration

When the Controller parameter is set to Ribbon, the Configuration parameter appears.

When the Configuration parameter is set to One Section, a single Destination can be assigned to the entire length of the Ribbon.

When the Configuration parameter is set to Three Sections, the Ribbon is divided into three equal sections, a Destination can be assigned to each section.

Position Mode

When the Controller parameter is set to Ribbon, the Position Mode parameter appears.

When the Position Mode parameter is set to **Relative**, wherever you touch the Ribbon becomes the “zero point” for sending values; you won’t notice any change in the sound until you slide your finger. Relative mode tends to be the most natural for performance—just wiggle your finger anywhere on the Ribbon to get vibrato in factory Programs and Multis. You get the same effect no matter where you do the wiggling.

Multi Edit Mode

CONTROLS Page

When the Position Mode parameter is set to **Absolute**, the zero point for the Ribbon stays in the same physical location on the ribbon. By default this is the center of the Ribbon, although you can use the Center parameter to move the zero point. In Absolute mode, just touching the Ribbon affects the sound (unless you touch it at exactly the zero point). Every movement you make along the Ribbon sends control values based on how far you are from the zero point.

Spring

When the Controller parameter is set to Ribbon, the Spring parameter appears.

When Spring is **On**, the Ribbon value “springs” back to its zero point automatically when you lift your finger off the ribbon.

When Spring is **Off**, the Ribbon value remains at its current value when you lift your finger off the Ribbon.

Center

When the Controller parameter is set to Ribbon, the Center parameter appears.

The Center parameter defines the center point for the Ribbon (or for each section on the Ribbon). The center point should typically match the Entry value, as the Ribbon will return to the center point after use when the Spring parameter is set to On. When the Spring parameter is set to Off, the Center parameter has no effect.

Center values of 0, 64 and 127 will place the center point at the left side, center, or right side of the ribbon (or each third of the ribbon when the Configuration parameter is set to Three Sections).

The Controller Destination List

The table below contains the available values for the MIDI CC (continuous controller) destinations. The PC4’s physical controllers can send MIDI values to these destinations in order to control the parameters of PC4 Programs, Multis, PC4 system parameters, or external MIDI equipment.

Controller Number	Controller Destination	Description
0	Bank	MIDI Bank change message
1	MWheel	Default destination for the Modulation Wheel
2	Breath	Default assignment for breath controller in compatible synths
3	MIDI 03	MIDI Controller 3
4	Foot	Default assignment for continuous foot controller in compatible synths
5	PortTim	Monophonic PC4 Programs respond to this Controller if portamento is turned on.
6	Data	MIDI Controller 6
7	Volume	MIDI Volume
8	Balance	MIDI Balance

Controller Number	Controller Destination	Description
9	MIDI 09	MIDI Controller 9
10	Pan	MIDI Pan
11	Express	Default assignment for CC Pedal. In most Programs it acts as a volume control. It scales between 0 and the current value of Volume.
12	MIDI 12	Default assignment for Slider 1
13	MIDI 13	Default assignment for Slider 2
14-21	MIDI 14-21	MIDI Controllers 14-21
22	MIDI 22	Default assignment for Slider 3
23	MIDI 23	Default assignment for Slider 4
24	MIDI 24	Default assignment for Slider 5
25	MIDI 25	Default assignment for Slider 6
26	MIDI 26	Default assignment for Slider 7
27	MIDI 27	Default assignment for Slider 8
28	MIDI 28	Default assignment for Slider 9
29	MIDI 29	Default assignment for Variation switch
30-31	MIDI 30-31	MIDI Controllers 30–31
32	MIDI Bank	MIDI Bank change message
33–63	MIDI 33–63	MIDI Controllers 33–63
64	Sustain	Default destination for Sustain Pedal
65	MIDI 65	MIDI Controller 65
66	Sostenuto	Default destination for Sostenuto Pedal (Sustains notes that are currently down, but not notes played subsequently.)
67	Soft	Lowers the volume by a preset amount and may soften the timbre as well.
68	Legato	Forces mono playback.
69	Freeze	Envelopes freeze at current state.
70–79	MIDI 70–79	MIDI Controllers 70–79
80	MIDI 80	Default assignment for Switch 1
81	MIDI 81	Default assignment for Switch 2
82	MIDI 82	Default assignment for Switch 3
83	MIDI 83	Default assignment for Switch 4
84	Portamento	Standard MIDI controller for setting Portamento starting note
85	MIDI 85	Default assignment for Switch 5
86	MIDI 86	Default assignment for Switch 6
87	MIDI 87	Default assignment for Switch 7
88	MIDI 88	MIDI Controller 88
89	MIDI 89	Default assignment for Switch 8
90	MIDI 90	Default assignment for Switch 9
91–95	MIDI 91–95	MIDI Controllers 94–95
96	Data Inc	Equivalent to pressing the Next Value button
97	Data Dec	Equivalent to pressing the Previous Value button
98	NRegParL	Non-Registered Parameter Least Significant Byte
99	NRegParM	Non-Registered Parameter Most Significant Byte
100	RegParL	Registered Parameter Least Significant Byte
101	RegParM	Registered Parameter Most Significant Byte
102–109	MIDI 102–109	MIDI Controllers 102–109

Multi Edit Mode

CONTROLS Page

Controller Number	Controller Destination	Description
110-119	MIDI 110–119	Reserved - Not available for use in the PC4.
120	Sound Off	Stops all sound in the corresponding channel.
121	RstCtrls	Resets Controllers to defaults in the corresponding channel.
122	Local	Reserved for use by MIDI specification.
123	Notes Off	Sends Note Off Message to all playing notes in the corresponding channel.
124	Poly	Reserved for use by MIDI specification.
125	Omni	Reserved for use by MIDI specification.
126	Mono On	Reserved for use by MIDI specification.
127	Mono Off	Reserved for use by MIDI specification.
128	Pitch	Values above 64 and below 64 bend the pitch up and down, respectively.
129	PitchRev	Values above 64 and below 64 bend the pitch down and up, respectively
130	PitchUp	Values above 0 bend the pitch up
131	PitchDwn	Values above 0 bend the pitch down
132	Pressure	Default Destination for Pressure
133	Tempo	Tempo
134	KeyNum	Triggers playback of notes by Key Number—e.g., C4 is 60. Send a velocity first with Destination 135, KeyVel.
135	KeyVel	Key Velocity
136	ProgInc	Program Increment—increments current Program number.
137	ProgDec	Program Decrement—decrements current Program number.
138	ProgGoto	Go to Program—selects Program.
139	MultiInc	Multi Increment—increments current Multi number.
140	MultiDec	Multi Decrement—decrements current Multi number.
141	SetpGoto	Go to Multi—selects Multi.
145	TransUp	Transpose Up (ST)
146	TransDown	Transpose Down (ST)
147	Arp On/Off	Values 0-63 turn the Arpeggiator Off, Values 64-127 turn the Arpeggiator On.
148	CC Seq On/Off	Values 0-63 turn the CC Sequencer Off, Values 64-127 turn the CC Sequencer On.
149	Mute Zone	Mute Zone – Values above 64 will mute the zone that sends values to this destination, values below or equal to 64 will unmute the zone.
150	ArpOrder	Arpeggiator PlayOrder, each range of values selects one of nine settings in order of the parameter list: 0-14, 15-28, 29-42, 43-56, 57-70, 71-84, 85-98, 99-112, 113-127. (See Play Order on page 3-29)
151	ArpBeats	Values from 0-127 change the Arpeggiator Beats value (see Beats on page 3-27 for details).
152	ArpShift	The 88 Arpeggiator Shift steps are scaled over the 128 MIDI controller values, so that 0 = 0 steps and 127 = 88 steps. (See Shift Amount on page 3-27 for details).
153	ArpLimit	The 60 Arpeggiator Shift Limit steps are scaled over the 128 MIDI controller values, so that 0 = 0 steps and 127 = 60 steps. (See Shift Limit on page 3-27)
154	ArpLmtOp	Arpeggiator Shift Limit Option, each range of values selects one of seven options in order of parameters list: 0-18, 19-36, 37-54, 55-72, 73-90, 91-108, 109-127. (See Limit Option on page 3-26)
155	ArpVel	Arpeggiator Velocity Mode, each range of values selects one of twenty-three options in order of parameters list: 0-5, 6-10, 11-15...101-105, 106-110, 111-127. (See Velocity on page 3-29).
156	Arp Dur	The Arpeggiator Duration % values are scaled over the 128 MIDI controller values, so that 0 = 1% and 127 = 100%. (See Duration on page 3-33)

Controller Number	Controller Destination	Description
157	Latch Sustain	To control the Arpeggiator Latch switch, 0-63 = off, 64-127 = on. (See Latch on page 3-24)
158	Latch2 Sost	To control the Arpeggiator Latch2 switch, 0-63 = off, 64-127 = on.
160	SusLatch	For Arpeggiator Latch Pedals mode, 0-63 = off, 64-127 = on.
161	Panic	Sends an "all notes off" message and an "reset all controllers" message on all 16 MIDI channels.
162	SoloZn	Solo Zone - Values above 64 will solo the zone that sends values to this destination, values below or equal to 64 will unsolo the zone. When soloing a Zone, all other Zones will become muted, and unmuteing a muted Zone will make that Zone the soloed zone. If the currently soloed Zone has a controller assigned to Destination 149 (Mute Zone), solo mode can be canceled by sending a value to this destination.
163	Riff OnOff	If Riff is set to On on the RIFF page, values 64-127 will trigger the riff, values 0-63 will release the riff.
165	Riff Duration	Controls the Riff Duration parameter. The Duration value is calculated by multiplying the received controller value by 1000, and dividing the answer by 128 (any decimal points are taken off the final value.) Here are some example values: 7 = 54%, 13 = 101%, 19 = 148%, 32 = 250%, 64 = 500%, 127 = 992%
166	Riff Velocity	Controls the Riff Velocity parameter. The Velocity value is calculated by multiplying the received controller value by 2. For Example, 25 = 50%, 50 = 100%, 100 = 200%, 127 = 254%.
167	Riff Delay	Controls the Riff Offset parameter. Controller value 64 = 0 offset ticks. Each value away from 64 = 512 offset ticks. For example, 63 = -512 offset ticks, 65 = +512 offset ticks, 0 = -32768 offset ticks, 127 = +32256 offset ticks.
168	TapTempo	Assign this to a switch (set to Type: Toggled) to control the tap tempo function, then tap the switch in time to set the Multi tempo.
170	-ArpShift	Sets ARPEGGIATOR values for Shift to negative. 0-63 = off, 64-127 = on. (See Shift Amount on page 3-27)
171	ShiftPatt	Selects one of the 128 patterns in the current ARPEGGIATOR Shift Pattern Bank. (See Shift Pattern on page 3-27)
172	ShiftPBank	A controller value selects the corresponding Shift Pattern Bank for the ARPEGGIATOR page of a controller's zone. For example, controller value 2 selects Shift Pattern bank 2, controller value 7 selects Shift Pattern bank 7.
173	VelPatt	Selects one of the 128 patterns in the current ARPEGGIATOR VelPatt Bank. (See Velocity Patt on page 3-31)
174	VelPBank	A controller value selects the corresponding Velocity Patt Bank for the ARPEGGIATOR page of a controller's zone. For example, controller value 2 selects Velocity Patt bank 2, controller value 7 selects Velocity Patt bank 7.
175	VelFixed	Set's arpeggiator velocity when ARPEGGIATOR Velocity Mode is set to Fixed. (See Velocity on page 3-29)
176	ShKeyNum	Shift Key Number (see below)
177	ShiftKey	Shift Key (see below)
178	ShKeyNuV	Same as 176 ShKeyNum, but the Shift Pattern's velocity will be modified by the current velocity pattern of the zone.
180	Chan Intonation	Selects the Intonation Map (IDs 0-127) in a MIDI channel in real time. On the Multi Edit CONTROLS page, when setting a switch controller to this Destination the name of the selected Intonation Map will be displayed. For example: 18 (EastMed).
181	Chan Int Key	Selects the Intonation Key (C through B) in a MIDI channel in real time. On the Multi Edit CONTROLS page, when setting a switch controller to this Destination the MIDI number and note name of the selected Intonation Key will be displayed. For example: 41 (D#).
182	Arp Step	Disable/enable an Arpeggiator Step Sequencer step by toggling the step velocity to None. Assign this destination to a Switch controller with Type set to Momentary, the On Value sets a step number to control, set the Off/Entry/Exit Values to None.
183	CC Seq Step	Disable/enable a CC Sequencer User Mode step by toggling the step value to None. Assign this destination to a Switch controller with Type set to Momentary, the On Value sets a step number to control, set the Off/Entry/Exit Values to None.

Shift Key Number, Shift Key (ShKeyNum, ShiftKey)

These controller destinations allow you to play musical scales and single note patterns on any programmable continuous controller in a Multi, without the need of playing the physical keys of the keyboard. These features are especially useful for playing fast arpeggiations. These destinations only work when combined with other destinations and features, so be sure to read this whole section to gain a complete understanding.

Shift Key Number (**ShKeyNum**, controller destination **176**) works in a similar way to Key Number (KeyNum, controller destination 134). Both controllers basically generate a monophonic stream of notes. The difference is that Key Number plays through all notes chromatically, while **Shift Key Number** only plays notes relative to a Shift Pattern.

For example, when controlling Shift Key Number from a slider, notes are triggered from a Shift Pattern in forwards order as you move the slider up, and backwards order as you move the Slider down. If a Zone contains the Shift Pattern 2: minor, the notes being played by the slider will be only the root, the minor third and fifth in the chosen key, triggering notes in any octave up and down the keyboard. (See Shift Key below for details on selecting the root note and octave.)

Selecting Notes:

You must select a Shift Pattern for the desired zone in order for Shift Key Number to have an effect. To select a Shift Pattern for the current zone in a Multi, enter the Multi editor, go to the Arpeggiator page and set Arp Mode to Classic. Set Shift Mode to Patt and select a Shift Pattern from the Shift Pattern field. If using multiple zones, a different pattern can be selected for each.

The Shift Pattern field is usually used with the arpeggiator, but can also be used in combination with the controller destinations Shift Key Note, Shift Key, and Key Velocity. These destinations can use a zone's Shift Pattern whether the arpeggiator is on or off without conflict. For more information on Shift Patterns such as editing and saving, see [Shift Pattern on page 3-27](#). (Note that the Shift Pattern Up or Down options, as well as any of the arpeggiator parameters other than Shift Pattern do not have an effect on Shift Key Number.) You can also set controllers to destination 171 (ShiftPatt) to select a pattern from the current bank of 128 shift patterns, and destination 172 (ShiftPBank) to select a bank from banks of 128 shift patterns each.

Selecting Velocity:

In order to have a note sound when using Shift Key Number, you first need to send a Key Velocity message (**KeyVel**, controller destination **135**) with a non zero velocity. To do this, use the Multi Controls page to assign a controller to Destination 135. It's useful to assign a slider or other continuous controller in order to control velocity while playing. Make sure this assignment uses the same Zone as ShKeyNum.

Notes triggered by Shift Key Number will be played with the last received KeyVel velocity. One note triggered by these controllers sounds until another note is triggered or until a KeyVel message with velocity 0 is sent.

Selecting Key (Root Note):

Shift Key (**ShiftKey**, controller destination 177) allows the user to select the key (root note) of the Shift Pattern triggered by Shift Key Number. A Shift Pattern is a relative pattern based on a root note. All notes triggered by a Shift Pattern are shifted from the root note by the value of each pattern step (in half-steps.)

Shift Key Settings	
Value	Key (Root note)
0-9	C
10-19	C#
20-29	D
30-39	D#
40-49	E
50-59	F
60-68	F#
69-78	G
79-88	G#
89-98	A
99-108	A#
109-118	B
119-127	Last Note Played

When using a Shift Pattern with Shift Key Number you can select the key with one or more controllers assigned to the Shift Key destination. (Make sure this assignment uses the same Zone as ShKeyNum.) You can use a continuous controller such as a slider to cycle through keys, or switches set to predetermined keys. For example, if you are playing a song that moves between 2 or 3 keys, a couple of switches could be programmed in order to send the appropriate Shift Key message for each key change. That way all the notes you are triggering with a Shift Key Number controller will be in the appropriate scale. You could also create a Multi for a song with multiple zones, each with its own pre-set key and appropriate shift pattern. That way, for each chord change you could move a different controller that would create the correct harmony.

Another way to choose a key is to set Shift Key to **Last Note Played** mode, in which the last note played in the zone will set the key. For example, you could set the zone being used for Shift Key Number to have a Key Range that covers only a few of the keyboard's lowest octaves. This would allow you to play root note bass lines that change the key that Shift Key Number plays in, leaving the upper octaves of the keyboard open for use by other zones.

A Note About Octave Range:

When using Shift Key Number, shift patterns with more than 12 steps begin triggering notes in higher octaves. This is done because longer shift patterns use up more of a controller's range, and limit the number of octaves that a single controller can trigger. Since the lowest octave of a program is often too low to be musically useful, the PC4 will automatically start triggering notes from longer shift patterns in higher octaves. This saves room in the controller's range of values for triggering more useful octaves. See the table below for Shift Pattern step ranges and their corresponding starting octave.

Multi Edit Mode

CONTROLS Page

If Shift Key is set to Last Note Played and no note is played, the default key is C. Each zone can have a different Shift Key, so you can have zones preprogrammed with the keys you want to use, or have them all in the same key, or just change the key in real time while you are playing.

Default Octave Shifting	
Total # of Shift Pattern Steps	Starting Octave
1-12	C0-C1
13-24	C1-C2
25-36	C2-C3
37-48	C3-C4

Selecting Octave Range:

You can adjust the pattern's starting octave by using the **Add** parameter on the Multi Edit Controls page containing your ShKeyNum assignment. In the Add field, the addition or subtraction of the number of steps in your current shift pattern will raise or lower the starting octave in relationship to the default starting octave. For example, in a shift pattern with 3 steps, an Add value of 9 would cause a controller value of 0 to make Shift Key Number trigger notes in octave C3-C-4, 3 octaves above the default C0-C1. Add values that are not multiples of the number of current shift pattern steps will change which step the pattern begins on at controller value 0, thus offsetting the relationship between all of the controller's values and current shift pattern's steps. (See [Add on page 7-18.](#))

Adjusting Controller Range:

When using Shift Key Number, the number of steps in the Shift Pattern also affects the range of values that will cause a controller to trigger a shift pattern step, and in turn affect the useful range of the physical controller. With a shift pattern of 12 notes, the 128 different notes that the PC4 can trigger are evenly spaced over the range of the controller. Patterns with less than 12 steps will trigger notes in every octave over a shorter range of the controller. For example, in a shift pattern with 3 steps, by default the controller values 0 to 2 will trigger notes starting in the lowest possible octave, and controller values 27 to 30 will trigger notes in the highest possible full octave. Using a or this controller, only about 1/4th of the length of the slider would be triggering notes. This decreased useful range makes the controller harder to use accurately. To remedy this, you can adjust a controllers behavior by using the **Scale** parameter on the Multi Edit Controls page containing your ShKeyNum assignment. Adjust the Scale value to stretch the useful values of the controller across it's whole physical range. A scale value of less than 100% will be helpful for patterns with fewer than 12 steps. Experiment by adjusting the scale value until the highest desired note is triggered at the top of the controller's physical range. See [Scale on page 7-17](#) for more details on the Scale parameter. For shift patterns with more than 12 steps, you will run out of controller values before your shift pattern triggers in every octave. If you want to be able to access all of the available octaves, you can achieve this by setting multiple controllers to Shift Key Number. Next, use the Scale and Add parameters for each controller, adjusting each to trigger the desired range of octaves (see [Add on page 7-18.](#))

FX Page

The FX Page allows you to set Aux send levels for each channel, select two Aux FX Chains and Mod controls, and set Aux FX output routing. You can also enable or disable FX resources for each channel, which is useful for managing Insert FX usage.

To select or edit Insert FX Chains for each program, use the Chain Editor from within the Program Editor.

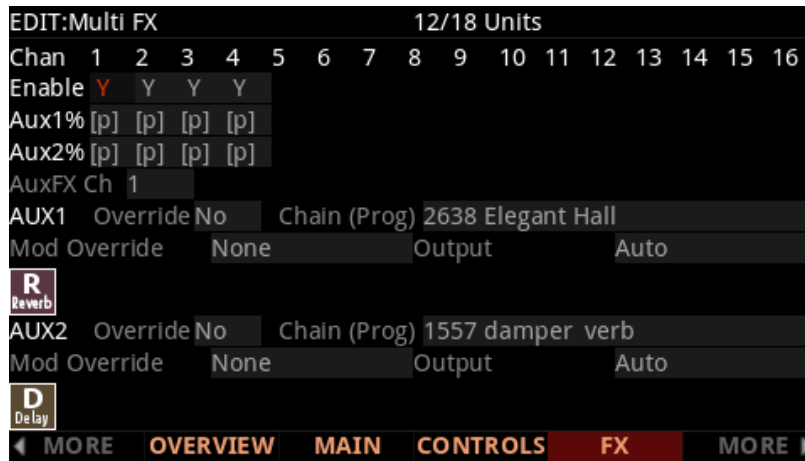

Enable

Use the Enable parameter to enable or disable the effects Chains of the Program in each MIDI channel. This is useful for disabling unused FX in some channels, in order to allocate FX unit resources for other channels.

Set each MIDI channel to Y to enable effects, or to N to disable effects.

The PC4 has 32 “units” of effects resources that can be used to load effects chains. Each FX chain requires a certain number of FX units in order to load, depending on its complexity.

The top line of the display shows a fraction with the number of units used by the selected channel, over the total number of units used. When attempting to use more than 32 units of FX resources at once, some FX Chains will not be loaded, and will be displayed as (Y). If you want to use the Insert or Aux effects Chain for a channel displayed as (Y), try setting other channels to N.

If the Channel number of the current “AuxFX Ch” setting is set to N or (Y), the Aux Chains will be disabled for all channels.

Aux FX Channel

The Aux FX Channel determines the MIDI channel that will be used for the Aux 1 and Aux 2 FX Chains. For example, if the Program in channel 2 uses the Chain “25 Basic Delay 1/8” as an Aux 1 Chain, then setting the Aux FX Channel to 2 allows the programs in all channels to send their signal to the Aux FX Chain “25 Basic Delay 1/8”.

Keep in mind that the MIDI channel number of each Zone does not have to match the Zone number. For example, if Zone 1 is assigned to use MIDI channel 5, then Aux FX Chan must be set to 5 in order to use the Aux FX Chains of Zone 1. To view or change the MIDI Channel for each Zone, see [Channel on page 7-7](#).

Aux1%, Aux2%

Use the Aux1% and Aux2% parameters to set the Aux 1 and 2 FX send levels for the Program in each MIDI channel.

The default setting “[p]” will use the dB level or wet/dry percent send value specified in the Program of the selected MIDI channel. To override one of these send level values, select the Aux1% or Aux2% parameter for the desired MIDI channel, and enter a new wet/dry percent send value (0=fully dry, 100=fully wet). A value of [p] can be set by entering -1 and then pressing the Enter button, or by using the Alpha wheel or +/- buttons to scroll below 0.



Note: In most factory Programs, the send level for Aux 1 is controlled by an Aux mod set to MIDI 28 (Slider 9.) If a send level override is set, it will usually be scaled by the entry value for Slider 9, with values of 0-127 scaling between 0% wet and the selected send level. To defeat this behavior, set the Mod Override parameter to ON. This will cause the Program to use the selected send level value.

AUX1 Override, AUX2 Override

Normally, the Aux Effects Chains are specified by the program on the specified Aux Effects channel. When Override is set to Yes, the Chain parameter can be selected, allowing you to choose a different Aux effect Chain.

Set Override to Yes to select an override Aux Chain on this page. Set Override to No to use the Aux FX chain of the specified Aux FX Channel.

Chain

When AUX1 Override or AUX2 Override is set to Yes, you can select an override Aux Chain for the corresponding Aux Effect. The Chain parameter can not be selected when Override is set to No, and “(Prog)” is shown as a reminder that the Chain from the Program on the Aux FX Channel is being used. Press the EDIT button to edit the selected Chain.

Mod Override

The Mod Override parameter allows you to select a controller or modulation source which will control the send level or dry/wet amount for the Aux 1 or Aux 2 Chain. Selecting a Mod Override will disable any Aux Mod controller or modulation source that was assigned in the Program of the Aux FX Channel.

If you select a MIDI controller for the Mod Override (entries 1 through 95 in the Mod Override list), you must select the same MIDI controller number in the “Destination” field for the desired controller on the Multi Controls page. This must be done for each Zone that you wish to apply the Mod override controller. The Multi Controls page allows you to set entry/exit values as well as scaling and offset values for the Mod Override controller.

When the Mod Override parameter is selected, you can quickly select one of the PC4’s physical controllers by holding the Enter button and moving the controller.

Output

This parameter specifies the physical audio output pair for the corresponding Aux Chain’s output. The settings A and B refer respectively to the A and B physical audio outputs of the PC4. Setting Output to Auto uses the output pair specified in the program on the specified Aux Effects channel.

ARP Page

The Arpeggiator in Multi Mode is very similar to the Program Mode arpeggiator. See [The Arpeggiator \(ARP\) Page on page 3-22](#) of the Program Edit Mode Chapter for a full description of each arpeggiator parameter.

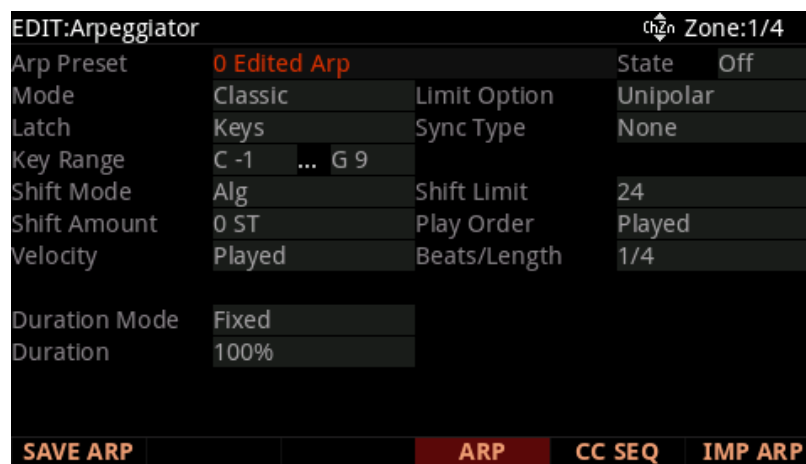

Multi Edit Mode

CC Sequencer (CC SEQ) Page

In Multi Mode, the Arpeggiator works the same as in Program Mode, except there is one arpeggiator per Zone. The Arpeggiator in each Zone can each have different settings, and they can be played at the same time. Also, in Multi Mode the Arpeggiator page does not have the Tempo parameter, instead the **Tempo** parameter on the Multi Common page should be used.

Unlike the Arpeggiator in Program Mode, the Arpeggiator in Multi Mode has the **Sync Type** parameter. Setting the Sync Type parameter to Any Beat will keep arpeggiators in sync to the same beat pulse across multiple Zones. When the Sync Type parameter is set to Any Beat, playing an arpeggiator in one Zone will wait for the next beat of any currently playing arpeggiators before starting. Set the Sync Type parameter to Off if you don't want to keep arpeggiators in sync. Additional Sync Type settings are available, which behave the same as the Riff Sync Types. See [Trigger SyncType on page 7-35](#) for details.

To assign the ARP and LATCH button for the arpeggiator in each Zone, go to the Controls page and set the Controller field to ArpOn/Off or ArpLatch for each desired Zone. See [“Switch Controllers” on page 7-13](#) for details.

Import Arpeggiator Settings (IMP ARP)

Press the IMP ARP soft button to copy the Arpeggiator settings from the Program of the currently selected Zone into the Arpeggiator page of the currently selected Zone.

CC Sequencer (CC SEQ) Page

The CC Sequencer in Multi Mode is very similar to the Program Mode CC Sequencer. See [The CC Sequencer \(CC SEQ\) Page on page 3-35](#) of the Program Edit Mode Chapter for a full description of each CC Sequencer parameter.

EDIT:MIDI CC Step Sequencer Zone:1/4

CC Seq Preset	0 Edited CC Seq	State	Off
Number Steps	4	Note Value	1/4
MIDI Dest	Zone	Sync	Free Run
Sequence	1	Seq State	On
Scale	100%	Scale Mod	None
Add	0	Add Mod	None
MIDI CC	12 Filter Freq	Mode	User

127 64 96 64
1 2 3 4

SAVE SEQ SEQ- SEQ+ ARP CC SEQ IMP SEQ

In Multi Mode, the CC Sequencer works the same as in Program Mode, except there is one CC Sequencer per Zone. The CC Sequencer in each Zone can each have different settings, and they can be played at the same time.

Import CC Sequencer Settings (IMP SEQ)

Press the IMP SEQ soft button to copy the CC Sequencer settings from the Program of the currently selected Zone into the CC Sequencer page of the currently selected Zone.

RIFF Page

Riffs are full songs or individual tracks of a song created in the PC4's Song mode that you can trigger in Multi mode. Standard MIDI files may also be imported to Song mode and then used as riffs in Multis. Every zone in a Multi can have its own riff—a completely independent sequence. You can use a Multi with many riffs to trigger and stop looped sequences of different instrument parts. Alternatively, a single riff can play multiple instrument parts, and each riff can be used as a different song section of a backing track.

EDIT:Multi Riff			chzn Zone:1/4	
Riff	On		Riff Tempo	Song
Song	0 None			
Start	1	1	0	
Stop	2	1	0	
Source Track	All		Re-Channel	Off
Loop	On		Local	Off
Transpose	Off		Root Note	C 4
Trigger Range	C -1	G 9	Offset	0
Release Range	C -1	G 9	Condit. Release	Off
Trigger Master	First Riff/Arp		Trigger Type	None
Release Master	First Riff/Arp		Release Type	None
Velocity	100%		Duration	100%
<div style="display: flex; justify-content: space-between; align-items: center;"> ◀ MORE RIFF COMMON ARP CC SEQ MORE ▶ </div>				

Follow these steps to use a riff:

1. Go to Song mode and find or record the song that you wish to use for your riff. Note the song ID#, as well as the desired track and start/stop points.
2. Go to Multi mode and edit a Multi. On the Multi Edit Overview page, choose the program that you want to use for the riff on the current zone. (Program changes that are recorded in song mode will be ignored when using the song as a riff in a Multi.)
3. Go to the RIFF page, set the Riff to On, then select the desired song, track, song Start/ Stop points. See below for descriptions of these parameters, as well as many other parameters that determine the behavior of a riff.



Note: By default, setting a zone to trigger a riff will disable the ability to play notes of that

zone's program from the keyboard. To re-enable this ability, see [“Local” on page 7-34](#).

Riff

Use the Riff parameter to turn the Riff feature On or Off for the currently selected Zone.

Song

Use the Song parameter to select the song that you wish to use for the Riff of the currently selected Zone.

Start, Stop

Use the Start and Stop parameters to specify the riff start and stop points. The time format is *Bar : Beat : Tick*. *Bar* can be set to any bar in the song, and *Beat* can be set to any beat in that bar (beat range is dependent on time signature.) *Tick* can be set from 0 to 959. See [Beat Subdivisions in Ticks on page 8-39](#) for a list of beat subdivisions in ticks.

Note: The Stop point is automatically adjusted so that the current riff is at least one beat long.

Transpose, Root Note

When the Transpose parameter is set to On, the riff can be transposed chromatically by playing the keyboard within the selected trigger range. Use the Root Note parameter to select the key that will play the riff at its original pitch. Root Note is only applied when the Transpose parameter is set to On.

For example, if Transpose is set to On and you have a riff based around D4, set the Root Note to D4 so that the riff will play in tune with other Zones. It is also useful to set the Root Note to a different octave than the original pitch, in order to play the riff at the original pitch from a higher or lower region of the keyboard.

Note: If you are transposing a riff that includes a Drum Track, you can prevent the drum track from being transposed by editing the song. See [“Drum Track” on page 8-13](#) for details.

Source Track

The Source Track parameter determines the song track or tracks that the riff plays. A riff can play either a single track or all tracks of the selected song.

To create a Multi with multiple riffs each playing a single instrument part, use the same song for the riff in each Zone, and select a different Source Track for each riff.

To create a Multi with a single riff that plays multiple instrument parts, set Source Track to All. Each track of the song will play through the zones which have a corresponding MIDI channel. See [“Channel” on page 7-7](#) for details on the MIDI channel used for each Zone.

Re-Channel

Song Track numbers and Multi Zone numbers have matching MIDI channel numbers by default. When the current zone’s MIDI channel and the channel of the riff’s selected Source Track do not match, it can make the riff play programs from other Zones. To prevent this you can use the Re-Channel parameter.

When Re-Channel is set to On, the track selected for the Source Track parameter will play through the MIDI channel of the current zone. For example, if you want to use a riff on zone 2 (set to use MIDI channel 2) and the riff was recorded on track 4 (set to use MIDI channel 4), you will need to turn Re-Channel on. If you were to do this and keep Re-Channel set to Off, the riff would play using the program from zone 4 (set to channel 4) instead of zone 2.

When Re-Channel is set to On and Source Track is set to All, *all* of the tracks of the song will play through the MIDI channel of the current zone.

Trigger Range

Use the Trigger Range parameters to set the keyboard range that will trigger the Riff. The left and right Trigger Range parameters set the lowest and highest keys that will trigger the Riff. For a key to trigger a riff, the key must also be within the Zone’s Key Range (set on the Overview page).

You can select a key using the Alpha Wheel, plus/minus buttons, or by pressing and *holding* the **Enter** button and pressing the desired key.

Note: Riffs can also be triggered and released by assigning a controller destination 163 **Riff OnOff**.

Release Range

Use the Release Range parameters to set the keyboard range that will stop the Riff when a key is released. The left and right Release Range parameters set the lowest and highest keys that will stop the Riff when a key is released. For a key to stop a riff, the key must also be within the Zone’s Key Range (set on the Overview page).

You can select a key using the Alpha Wheel, plus/minus buttons, or by pressing and *holding* the **Enter** button and pressing the desired key.

Note: Riffs can also be triggered and released by assigning a controller destination 163 **Riff OnOff**.

Conditional Release (Condit. Rel)

When the Condit. Rel parameter is set to On, the riff will play when a key is pressed and held, and other keys will not stop or restart the riff until the key original key is released. To use conditional release, set the same range for the Trigger Range and Release Range. To stop the riff, release the original key.

Local

When Local is set to Off, notes will only be played by the riff. When Local is set to On, notes in the current zone can be played normally by the keyboard, and by the riff.

Loop

When Loop is set to Off, the riff will play once until it is retriggered. When Loop is set to On, the riff will play in a loop until a key in the Release Range is released.

Riff Tempo

Use the Riff Tempo parameter to set the tempo of your riff. With Riff Tempo set to **Song**, the riffs original tempo from song mode will be used. With Riff Tempo set to **Multi**, the tempo set on the Multi Edit Common page will be used. The Multi setting is useful for tempo syncing different riffs or arpeggiators. With Riff Tempo set to **External**, the riff will sync to external MIDI clock. You can also manually choose a tempo by selecting a value from **20** to **400**.

Trigger SyncZone

The Trigger SyncZone parameter determines which zone a riff will sync to when triggered. This allows you to trigger riffs in sync with other riffs or arpeggios by syncing to the beat of riffs or arpeggios in other zones.

For example, if you have a drum riff in zone 1 and a bass riff in zone 2, you may always want the bass riff in zone 2 to sync to the drum riff in zone 1. In this case you would set the bass riff Trigger SyncZone to **Riff 1**.

You may want to have a little more freedom and not be tied to the drum riff as the main “timekeeper.” Maybe you want to start with the bass riff and have the drum riff start later. In this case you would set Trigger SyncZone to **First Riff Available** With this setting, the riff will look for the first available riff to sync to. So if both the drum riff and the bass riff have this parameter set to **First Riff Available**, the riff that is started first will be the master. If the bass riff starts first, the drum riff will see that as the first available riff to sync to and will do

so. If the drum riff is started first, the bass riff will see that as the first available riff to sync to and will do so. This can be very handy if you have multiple riffs and want to do some live remixing; you could have the drums drop out, and—as long as there is a riff playing—they will sync back up when triggered again.

You can also choose **First Arp Available**, which behaves the same way as **First Riff Available**, but makes your riff look for the first available arpeggiator to sync to. A setting of **First Available** will sync the riff to the first available riff, arpeggiator, or song from Song mode. A setting of **Main Song** will sync the riff to the song currently loaded in Song mode (useful when recording a Multi into Song Mode). See for [“Recording A Multi To Song Mode” on page 6-11](#) for details.



Note: If you have multiple riffs or arpeggiators already playing when using First Riff Available, First Arp Available, or First Available for the current riff, the current riff will sync to the riff or arpeggiator of the lowest numbered zone that has a riff or arpeggiator playing.

Trigger SyncType

The Trigger SyncType parameter allows you to choose how your riff will sync to other riffs, arpeggiators, and Songs (in combination with the Trigger SyncZone parameter).

With Trigger SyncType set to **None**, the riff will start playing as soon as it is triggered. It will not sync to anything. With Trigger SyncType set to **Down Beat**, if there is already something playing to sync to, the current riff will wait for the Down Beat of the next measure before starting; so, you can trigger the riff to start ahead of time, and have it start in sync at the Down Beat of the next measure. With Trigger SyncType set to **Any Beat**, if there is already a something playing to sync to, the riff will wait only until the next beat. Depending on when you trigger the riff, it will sync up, but it may be on an upbeat or a Down Beat.

With Trigger SyncType set to **Down Beat Wait**, the riff will wait for the Down Beat of the next measure to start. The difference from Down Beat is that if there is nothing playing to sync to, the riff will not start. This can be useful if you want to start multiple riffs synced to one riff. You could have a bass riff set to Down Beat Wait, for instance, and trigger the riff while no other riffs are running. As soon as you start another riff, the bass riff will start playing as well (provided that it is set to sync to another riff or to the first available riff.) If another riff is already running, Down Beat Wait behaves just like Down Beat.

With Trigger SyncType set to **Any Beat Wait**, the riff will wait for the next beat to start. The difference from Any Beat is that if there is nothing playing to sync to, this riff will not start. This can be useful if you want to start multiple riffs synced to one riff. You could have a bass riff set to Any Beat Wait, for instance, and trigger the riff while no other riffs are running. As soon as you start another riff, the bass riff will start playing as well (provided that it is set to sync to another riff or the first available). If something is already playing to sync to, Any Beat Wait behaves just like Any Beat.

With Trigger SyncType set to **Loop**, if there is already a riff or song playing to sync to, the current riff will wait for the playing riff or song to restart its loop (if Loop is set to On) before starting (see [“Loop” on page 7-34](#) for looping riffs, and [“Loop” on page 8-11](#) for looping songs). This way you can trigger the riff to start ahead of time, and have it start in sync at the start of the playing riff or song’s loop.

With Trigger SyncType set to **Stop**, if there is already something playing to sync to, the current riff will wait for what is playing to stop before starting. This way you can trigger the riff to start ahead of time, and have it start in sync at the release (stopping) of the riff, arpeggiator, or song that you are syncing to.

With Trigger SyncType set to **Start Wait**, if there is nothing playing to sync to, the current riff will wait for something it can sync to begin playing first before starting. This is similar to Down Beat Wait, but it will only trigger the riff the first time that whatever it is syncing to starts. This way you can trigger the riff to start ahead of time, and have it start in sync at the start of the riff, arpeggiator, or song that you are syncing to. If you stop the riff and try to start it again while the thing you are syncing to is already playing, Start Wait will not start the riff.

With Trigger SyncType set to **Loop Wait**, if there is already a riff or song playing to sync to, the current riff will wait for the playing riff or song to restart its loop (if Loop is set to On) before starting (see [“Loop” on page 7-34](#) for looping riffs, and [“Loop” on page 8-11](#) for looping songs). This way you can trigger the riff to start ahead of time, and have it start in sync at the start of the playing riff or song’s loop. The difference from Loop is that if there is nothing playing to sync to, the riff will not start. If the riff or song that you are syncing to is already running, Loop Wait behaves just like Loop.

With Trigger SyncType set to **Stop Wait**, if there is already something playing to sync to, the current riff will wait for what is playing to stop before starting. This way you can trigger the riff to start ahead of time, and have it start in sync at the release (stopping) of the riff, arpeggiator, or song that you are syncing to. The difference from Stop is that if there is nothing playing to sync to, the riff will not start. This can be useful if you want to get your riff ready to sync before you start whatever you are syncing it to. If the riff or song that you are syncing to is already running, Stop Wait behaves just like Stop.

Release SyncZone

Release SyncZone has the same settings available as Trigger SyncZone, but Release SyncZone determines what the releasing (stopping) of the current riff will be synced to when a parameter other than **None** is selected for Release SyncType.

Release SyncType

Release SyncType has the same settings available as Trigger SyncType, but Release SyncType determines how the releasing (stopping) of the current riff will be synced to other riffs, arpeggiators, and Songs (in combination with the Release SyncZone parameter).

With Release SyncType set to **None**, your riff will stop playing as soon as it is released. It will not sync to anything. With Release SyncType set to **Down Beat**, if there is already something playing to sync to, the current riff will wait for the Down Beat of the next measure before stopping when released; so, you can trigger the riff to stop ahead of time, and have it stop in sync at the Down Beat of the next measure. With Release SyncType set to **Any Beat**, if there is already a something playing to sync to, the riff will wait only until the next beat before stopping when released. Depending on when you release the riff it will stop in sync with a beat, but it may be on an upbeat or a Down Beat.

With Release SyncType set to **Down Beat Wait**, the riff will wait for the Down Beat of the next measure to stop when released. The difference from Down Beat is that if there is nothing playing to sync to, the riff wont stop when released. If another riff is already running, **Down Beat Wait** behaves just like **Down Beat**.

With Release SyncType set to **Any Beat Wait**, if there is already a something playing to sync to, the riff will wait for the next beat before releasing. The difference from Any Beat is that if there is nothing playing to sync to, this riff will not stop when released. This can be useful if you want to stop a riff in sync only when another riff is playing. If something is already playing to sync to, Any Beat Wait behaves just like Any Beat.

With Release SyncType set to **Loop**, if there is already a riff or song playing to sync to, the current riff will wait for the playing riff or song to restart its loop (if Loop is set to On) before starting (see [“Loop” on page 7-34](#) for looping riffs, and [“Loop” on page 8-11](#) for looping songs). This way you can release the riff to stop ahead of time, and have it stop in sync at the start of the playing riff or song’s loop.

With Release SyncType set to **Stop**, if there is already something playing to sync to, the current riff will wait for what is playing to stop before releasing. This way you can trigger the current riff to release ahead of time, and have it stop in sync at the release (stopping) of the riff, arpeggiator, or song that you are syncing to.

With Release SyncType set to **Start Wait**, if there is nothing playing to sync to, the current riff will wait for something it can sync to to begin playing first before releasing. This is similar to Down Beat Wait, but it will only release the riff the first time that whatever it is syncing to starts. This way you can trigger the riff to stop ahead of time, and have it stop in sync at the start of the riff, arpeggiator, or song that you are syncing to. If you restart the riff and try to release it again while the thing you are syncing to is already playing, **Start Wait** will not stop the riff.

With Release SyncType set to **Loop Wait**, if there is already a riff or song playing to sync to, the current riff will wait for the playing riff or song to restart its loop (if Loop is set to On) before starting (see [“Loop” on page 7-34](#) for looping riffs, and [“Loop” on page 8-11](#) for looping songs). This way you can trigger the riff to stop ahead of time, and have it stop in sync at the start of the playing riff or song’s loop. The difference from Loop is that if there is nothing playing to sync to, the riff will not stop when released. If the riff or song that you are syncing to is already running, **Loop Wait** behaves just like **Loop**.

With Release SyncType set to **Stop Wait**, if there is already something playing to sync to, the current riff will wait for what is playing to stop before releasing. This way you can trigger the riff to stop ahead of time, and have it start in sync at the release (stopping) of the riff, arpeggiator, or song that you are syncing to. The difference from **Stop** is that if there is nothing playing to sync to, the riff will not stop when released. If the riff or song that you are syncing to is already running, **Stop Wait** behaves just like **Stop**.



Note: For all **Release SyncType** settings except **Stop**, **Start Wait** and **Stop Wait**, a riff can sync its release with its self. For example, you could use riff 1 and sync it to its self by setting **Riff 1** for the **Release SyncZone** parameter. Then, if you set **Down Beat** for the **Release SyncType** parameter, when released the riff would always wait until its next Down Beat to stop.

Duration

Duration changes the duration of each MIDI note. The original durations of the notes in the sequence are multiplied by the selected percentage. 100% will cause no change, values smaller than 100% will result in shorter durations, values larger than 100% will result in longer durations.

Velocity

Velocity changes the velocity of each MIDI note. The original velocities of the notes in the sequence are multiplied by the selected percentage. 100% will cause no change, values smaller than 100% will result in lower velocities, values larger than 100% will result in higher velocities.

Offset

You can fine tune the start time of your riff in ticks by using the Offset parameter. A positive value will delay the start time, while a negative value will speed up the start time.

Real-time Control of Riff Parameters

You can have real-time control over several Riff parameters, by assigning physical controllers to special Riff Controller Destinations. Any input (or entry value) from a physical controller assigned to a Riff Controller Destination overrides the programmed values for the parameters of the riff on that controller's zone. The override remains in effect until you select a different Multi. Remember, each of the following Controller Destinations affects only the riff for the zone which your controller is assigned to.

Controller Number	Controller Destination	Description
163	Riff OnOff	If Riff is set to On on the RIFF page, values 64-127 will trigger the riff, values 0-63 will release the riff.
165	Riff Duration	Controls the Riff Duration parameter. The Duration value is calculated by multiplying the received controller value by 1000, and dividing the answer by 128 (any decimal points are taken off the final value.) Here are some example values: 7 = 54%, 13 = 101%, 19 = 148%, 32 = 250%, 64 = 500%, 127 = 992%
166	Riff Velocity	Controls the Riff Velocity parameter. The Velocity value is calculated by multiplying the received controller value by 2. For Example, 25 = 50%, 50 = 100%, 100 = 200%, 127 = 254%.
167	Riff Delay	Controls the Riff Offset parameter. Controller value 64 = 0 offset ticks. Each value away from 64 = 512 offset ticks. For example, 63 = -512 offset ticks, 65 = +512 offset ticks, 0 = -32768 offset ticks, 127 = +32256 offset ticks.

COMMON Page

The COMMON page contains parameters that affect all zones in the current Multi.



Tempo

When Clock Source is set to Internal, use the Tempo parameter to set the Multi tempo in BPM (beats per minute). The Multi Tempo sets the tempo of any tempo based effects, and can also be used to sync the tempo of Arpeggiators and Riffs on different Zones.

You can also set the tempo using the TAP button or Tempo knob (located in the front panel TEMPO section). To set the tempo press the TAP button a few times at the desired rate, or use the TEMPO knob.

When Clock Source is set to External, the Tempo parameter disappears from the display.

Clock Source

When Clock Source is set to Internal, the Multi will determine its tempo with the Tempo field. When Clock Source is set to External, the Multi can be synced to the tempo of an external MIDI device, which must send MIDI clock data to the PC4 via MIDI or USB.

KB3 Channel

If KB3 Organ Programs are selected for more than one Zone, this parameter specifies which MIDI Channel has priority to load a KB3 Program. Only one KB3 Program can be loaded at a time. If you want a KB3 Program to play in a zone, set the KB3 channel to the channel of the Zone. If no KB3 programs are selected in the current Multi, the KB3 Channel will be set automatically when a KB3 program is selected for the first time.

Audio In FX (AUDIO IN) Page

Press the AUDIO IN soft button to access the Audio In FX page. The Audio In FX page allows you to choose an FX chain to apply to the rear panel Audio Input jacks, and enable or disable the use of any existing FX Mods in the selected Chain. Each Multi can be saved with its own Audio Input settings, or be set to use the Audio Input settings set in Global Mode.

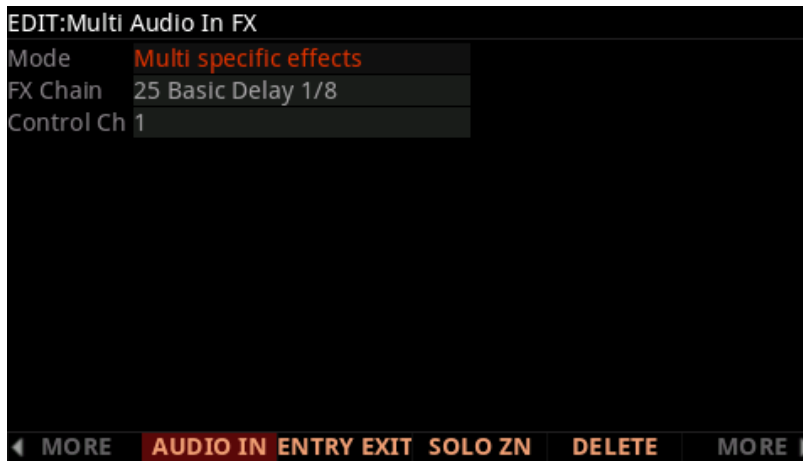

Mode

The Mode parameter determines whether the Multi will use its own Audio Input settings, or whether it will use the Audio Input settings set in Global Mode.

By default, Mode is set to “**Use Global Mode Effects**”, which means the Multi will use the Audio Input settings set on the Global Mode MAIN 1 page (for details see [MAIN 1 Page on page 9-1](#)).

Set Mode to “**Multi Specific Effects**” to enable Audio input effects for the current Multi. When “Multi Specific Effects” is selected, the FX Chain and Control Ch parameters will appear.

FX Chain

When the Audio Input Mode parameter is set to “Multi Specific Effects”, you can use the FX Chain parameter to select an FX chain to apply to the rear panel Audio Input jacks. To edit a Chain, enter the Chain Editor by pressing the EDIT button (see [Ch. 4 The Effects Chain Editor](#) for details).

When selecting an Audio Input Chain, the Chain may steal FX unit resources from other channels in order to load. Because of this you may see some Channels on the FX page become set to (Y) (higher numbered channels will be stolen first).

Multi Edit Mode

The Soft Button Functions

Control Channel (Control Ch)

Use the Control Ch parameter to set the MIDI channel on which you wish to control Chain Mods. See [Channel on page 7-7](#) for details on Multi Zone MIDI Channels.

Effect Chain Mods are modulation controls which can be assigned to the PC4's physical controllers. Any Mods assigned within the selected Audio Input Chain can be controlled by controllers assigned within the Multi.

To view the Mods of the selected Audio Input Chain, select the Chain field and press the EDIT button to enter the Chain Editor, then go to the Chain Info page (see [Ch. 4 The Effects Chain Editor](#) for details).

To control these Mods, assign a Multi controller to send these CC numbers using the Destination field on the Multi Controls page (see [CONTROLS Page on page 7-13](#) for details). The Zone used to send these CC numbers must have a MIDI Channel which matches the Audio Input Control Channel (see the Control Ch parameter, above). See [Channel on page 7-7](#) for details on setting the MIDI Channel of each Zone.

The Soft Button Functions

Some of the soft buttons in Multi Edit Mode perform a function when pressed.

ENTRY EXIT

Press the ENTRY EXIT to toggle between showing Pan/Volume and ExitPan/ExitVol on the Overview page. ExitPan and ExitVol are MIDI Pan (CC 10) and MIDI Volume (CC 7) messages that can be sent to each Zone's MIDI channel when exiting the current multi by selecting another Multi or Program. These parameters can be set to a value of "None", which sends no message. To select a value of none, scroll below 0 or type -1 followed by the Enter button.

Sending an Exit Volume message of 0 can be useful for silencing an external MIDI instrument when exiting a Multi. For Zones which are playing local programs, Exit Volume should typically be set to None to avoid unwanted volume changes when selecting Multis.

SOLO ZN

Press the SOLO ZN soft button to solo the current Zone.

New Zone (NEW ZN)

Create a new Zone, placed above the highest existing Zone.

Duplicate Zone (DUP ZN)

Create a new copy of the current Zone, duplicating the settings of all its parameters, placed above the highest existing Zone.

Import Zone (IMP ZN)

Copy a specific Zone from another Multi into the current Multi. Press the IMP ZN soft button to view the Import Zone page. Use the Import Zone page to select a Multi and Zone to import, then press the IMPORT soft button to import the Zone. The imported Zone will be placed above the highest existing Zone.

Delete Zone (DEL ZN)

Press the DEL ZN soft button to delete the currently selected Zone.

DELETE

Press the DELETE soft button to delete the current Multi (factory Multis can not be deleted).

The Mode Button Functions

In Multi Edit Mode, the Mode buttons act as shortcuts for some functions.

Program Mode Button (Solo Layer)

Press the Program Mode button to temporarily solo the currently selected Zone.

Multi Mode Button (Mute Layer)

Press the Multi Mode button to temporarily mute the currently selected Zone.

Song Mode Button (FX Bypass)

Press the Song Mode button to temporarily bypass the Insert and Aux FX Chains.

Chapter 8

Song Mode

To access Song Mode, press the SONG mode button. Use Song Mode to record and play multi-track songs sequenced by MIDI.

A MIDI sequencer is similar in some ways to a multi-track audio recorder: you can record and play back all sorts of music and sounds, layer sounds on top of other sounds, and change or manipulate things that you've previously recorded. Unlike an audio recorder, however, you do not actually record sounds with a sequencer. Rather, you are recording MIDI commands that cause sounds to be played.

There are several advantages to recording a song by sequencing. For example, you can make changes to the timing and pitch of individual notes, as well as change the instrumentation of previously recorded sequences.



Note: Song Mode has no “undo” function. Before recording to a track or making any kind of edit to the current song, you should save the current version of your song if you have made unsaved changes that you wish to keep. After doing this, if you make changes that you wish to undo, you can select a different song, select No when asked to save the changes, then select your song again. This will allow you to return to a previously saved version of your song. Also, as you work on a song it can be helpful to save multiple versions of a song at different ID numbers (for example, save a backup version before performing a Track function or overdub). This allows you to have multiple back up versions of a song, which can be useful in case you accidentally save changes that you want to undo.



Note: See [“Pan/Vol Initial Values” on page 8-14](#) and [“Prog Initial Values” on page 8-15](#) for details on setting initial Program, Volume and Pan values for each track. Initial values are needed in order for songs to sound correct after being saved and recalled.

The TRANSPORT Section

Use the TRANSPORT section of the front panel to control playback and recording.

The PLAY/PAUSE Button

When the song status is Stopped, press the **PLAY/PAUSE** button to play the song from the bar and beat specified by the Locate parameter.

When the Song Status is Rec Ready, press the **PLAY/PAUSE** button to begin recording.

When the song is status is Playing, press **PLAY/PAUSE** to pause the playback. Press **PLAY/PAUSE** again to continue playing from the same location.

When the song is status is Recording, press **PLAY/PAUSE** to stop the recording, as if you had pressed the **STOP** button.

The STOP Button

When the song is status is Playing or Recording, press the **STOP** button to stop playback or recording and reset the song's location to the bar and beat previously specified by the Locate parameter. If the location previously specified by the Locate is something other than Bar 1, Beat 1, press **STOP** twice to reset to **1:1**.

When the song is status is Recording, pressing the **STOP** button will display the "Save Changes" dialog (see below).

The RECORD Button

RECORD: When the Song Status is Stopped, press the **RECORD** button to change the Song Status to Rec Ready. When the Song Status is Playing, press the **RECORD** button to change the Song Status to Recording.

The LOCATE START Button

When the Song Status is Stopped, press the **LOCATE START** button to reset the Locate parameter to Bar 1, Beat 1.

The LOCATE BACK Button

Press the **LOCATE BACK** button to subtract one Bar from the current value of the Locate parameter.

The LOCATE FORWARD Button

Press the **LOCATE FORWARD** button to add one Bar to the current value of the Locate parameter.

Controlling the TRANSPORT Section with External Sequencers

You can control the **PLAY/PAUSE**, **STOP**, and **RECORD** buttons from an external sequencer sending MIDI Machine Control (MMC) messages. To receive MMC messages, the Receive MMC parameter on the Global Mode MIDI page must be set to On.



Note: If you are triggering PC4 sounds from an external sequencer that sends MMC messages, either turn off outgoing MMC on the external sequencer, or make sure the Receive MMC parameter on the Global Mode MIDI page is set to Off. If this is not done, you will simultaneously trigger the PC4 from the external sequencer and from the currently selected song in Song mode.

The Save Changes Dialog

The following dialog appears after you have recorded a track and pressed **STOP**.

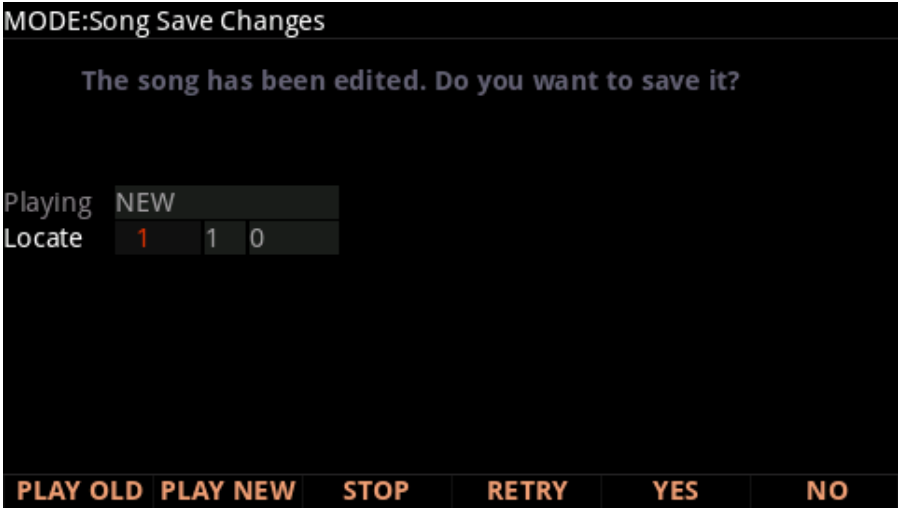

The **PLAY NEW** soft button allows you to play the song with your last recorded performance. You will likely want to hear this first.

Song Mode

The Save Changes Dialog

Pressing **PLAY OLD** will play the current song, minus the performance that you just recorded. You can toggle between Play Old and Play New without restarting the song by pressing either button while the song is playing. This is useful to check if your last performance was better or worse than what was previously saved (if anything was previously saved).

The Playing field displays whether to *NEW* or *OLD* version is playing.

The Locate field allows you choose a start time for the old or new playback. This is useful when you just want to hear a certain part of the song without listening to the whole thing.

STOP halts the playback of the song and resets the song's location to the bar and beat previously specified by the Locate parameter.

Pressing **RETRY** restarts recording from the same point you last started recording at.

Pressing YES

YES saves the song with the performance you just recorded. The Save Dialog will be displayed.

Use the Save Dialog to save the Song by selecting a User ID to save to, and renaming the Song if desired. Saving changes to a Song is very similar to saving a user program, see [Save User Programs on page 2-10](#) for more details.

Pressing NO

If you decide not to save or rename, **NO** returns you to the Song-mode page in which you were last recording. Changes to the current song are not saved, though the sequencer will remember changes to certain settings from the MAIN page. These settings are Tempo, Merge/Erase Mode, Locate, track mute status, Time In, Time Out, Song End, Loop, Punch, and Metronome. To permanently save these changes with the song, make sure to press the SAVE button before powering off or loading a new song. Alternatively, you will be prompted to save these changes upon loading a new song if the MAIN page settings were changed while recording or with recording armed.

The MAIN Page

The Song mode MAIN Page allows real time recording and playback, song and track selection. From this page you can view and edit the tracks' channel, program, volume and pan settings, and other parameters.

MODE:Song Main				Stopped			
Song	0*New Song*			Tempo	120	0	
Rec Track	1			Volume	127		
Program	1 Dyn 9ft Grand			Pan	64		
Locate	1	1	0	Overdub Mode	Merge		
Time In	1	1	0	Record Mode	Linear		
Time Out	8	1	0	Loop	Off		
Song End	8	1	0	Metronome	Rec		
Time Signat	4	4		FX Track	1		
Activity							
Track Status	R	-	-	-	-	-	-
Channel	1	2	3	4	5	6	7
Drum Track	N	N	N	N	N	N	N
◀ MORE MAIN MIXER MISC NEW SONG ▶ MORE							

Song Status

The Song Status is shown on the top line of the display:

- Stopped** The default status; also appears when you press the **Stop** or **Pause** button.
- Playing** Appears when the **Play** button is pressed (if recording is not armed).
- Rec Ready** Appears when the **Record** button is pressed while Song Status is Stopped. When Rec Ready is displayed, it indicates that Song mode is waiting to start recording.

Song

This shows the ID and name of the song currently selected for recording, playback, or editing. When a song is selected, Program Change, Volume, and Pan information is sent to all MIDI channels assigned to tracks that have events on them, and the internal clock is set to match the setting of the Tempo parameter. When looking for a previously saved song, you can scroll through songs while the sequencer is playing to quickly hear the beginning of each.

Recording Track (Rec Track)

The Rec Track parameter determines which track is record enabled. You can select a single track, or set Rec Track to **Mult** to record more than one channel simultaneously. See the Track Status section below for details on arming multiple tracks.

The parameter(s) below Rec Track change according to the value of Rec Track. If Rec Track is set to a single track (**1–16**), Program is displayed and you can select the program to be assigned to that track. If you switch through the channels, the program also changes, showing the program currently assigned to that channel.

If you change Rec Track to **None** or **Mult**, the display changes to show Track. This field indicates which track is currently being triggered by the keyboard, and you can use this Track field to select a track.

Program

Use this field to select a program before initially recording each track of your song. A program selected on the current Rec Track becomes the track's initial program the first time that the track is recorded. An initial program is the program that will be used for a track when it is played from the start of bar 1 (or any other point if there are no program changes and Control Chase is turned on, see [“Control Chase” on page 8-17](#)). Programs selected in Program Mode are selected as the program on the current Rec Track when you enter Song mode.

Follow these steps to change the current Rec Track's initial program after recording has taken place on that track. While the song is stopped, press **Record**, select the program, press **Stop**, and save the song. (This preserves all changes you have made to any other track parameters: volume, pan, tempo, etc.) You can also change the initial program at the top of a track's EVENT list (see [“The EVENT Page” on page 8-36](#)).

Any MIDI program changes recorded on the current Rec Track cause the ID and name of the track's program to change during playback. Program changes can be written to the event list of the current Rec Track by changing the Program parameter while recording. If a program change takes place, the program will only return to the initial program if triggered by another program change, or if the song is stopped and restarted from the beginning. One exception to this is when using the Control Chase feature, you would only need to restart the song before the first program change in order to return to the initial program (see [“Control Chase” on page 8-17](#)).

The Program parameter changes to Track if Rec Track is set to None or Mult. This field indicates which track is currently being triggered by the keyboard, and you can use this Track field to select a track.

Track Number (Track)

This parameter is available only when Rec Track is set to **None** or **Multi** (replacing the Program parameter). It indicates which track is currently being triggered by the keyboard, and you can use this field to select a track.

Tempo

The Tempo parameter determines the initial tempo for the selected song. The song will always start playback at the initial tempo. Whatever the tempo is set to when you record your first track will be the song's initial tempo. During playback, the current tempo is shown in this field. During recording, changing the tempo value will record changes to the Tempo Track. The initial tempo and other tempo changes can also be edited in the event list for the Tempo Track. The Tempo track also allows you to program more precise fractional tempos with two decimal places.

To quickly change a song's initial tempo, make sure the song is stopped, press **Record** to change the Song Status Rec Ready, set the desired tempo, then press **Record** again to change the Song Status to **Stopped**. The initial tempo can also be changed at the top of the event list for the Tempo track on the EVENT page. Make sure to save the song after changing the initial tempo.



Note: You can also set the tempo using the TAP button or Tempo knob (located in the front panel TEMPO section). To change the initial tempo, set the Song Status to Rec Ready, then press the TAP button a few times at the desired rate, or use the TEMPO knob.

You can also set the tempo to be controlled by an external sequencer. Use the Alphanumeric Pad to enter "0" in the tempo field, and press enter. "EXT" will appear in the tempo field. Any MIDI Time Clock (MTC) signal received at the PC4's USB or MIDI in port will now set the Song playback tempo.

Volume

You can set a volume level for each track as a value between **0** and **127**. If the channel of the Rec Track (or the control channel, if Rec Track is set to **Multi** or **None**) contains any recorded volume change (continuous controller 7), the change will be reflected as the Volume parameter's value in real time, as well as on the MIXER page. Also, changing the Volume value while recording will write volume automation (CC 7 messages) to the current Rec Track's event list.



Initial Volume Settings

Each song file does not automatically save your volume setting for each track. To make a song save your volume settings for each track, you must write an initial volume for each track. Initial volume is the volume setting that will be used when your song is played back from the start of bar 1. An initial volume setting is essentially a volume automation message that is written before the first tick of a track. Initial volume settings are not automatically written during recording because they make it harder to try out different volume settings for a track. For example, an initial volume will reset any volume adjustments that you make during playback each time the song is stopped and played from the start of bar 1, or if the song is stopped and played from any point if the Control Chase parameter set to On on the Song MISC page (see [“The MISC Page” on page 8-17](#)). If you plan to try out different volume settings, it is easier if you write an initial volume after you have found the desired setting.

Setting Initial Volume Per Track

Follow these steps to change the current Rec Track's initial volume. While the song is stopped, press the RECORD button, change the value of Volume, press the STOP button, and save the song. Use the same method to quickly set initial program or pan settings. Initial program, volume, and pan can also be set at the top of each track's event list (see [“The EVENT Page” on page 8-36](#)).

Setting Initial Values For All Tracks

An important last step before saving a finished song is to store initial values of Program, Volume and Pan for all tracks. This can be done at any time, but is best done as a last step if you plan to make a lot of adjustments to these settings. To write initial settings for all tracks, press the KEEP soft button on the Song Mixer page (see [“The MIXER Page” on page 8-14](#)). After pressing the KEEP soft button you must save your song to save these settings. Pressing the KEEP soft button stores the current value of each track's Program, Volume and Pan settings as initial settings. Be sure that these values on each track are set to the value that you wish to store, as the settings may have changed if you have written any automation.



Note: Don't use the KEEP soft button if you would like certain tracks to not be stored with initial values. In this case, only set initial values for each desired parameter as described above in [“Setting Initial Volume Per Track”](#).

Volume Sources When An Initial Volume Is Not Set

Volume settings are tied to MIDI channels, so the volume of each track will be dependent on which MIDI channel is assigned to each track in each song. If an initial volume is not stored with each track of a song, the each track will use the last volume setting set in each MIDI channel. For example, if you are in Song mode and have played a song, and then you load a song without initial volumes, the volume of each track of the newly loaded song will be set

by the MIDI channel volumes in the previously played song. If you are in Song mode and you load a song that does not have initial volumes without playing another song first, each MIDI channel will have the volume settings last used in Program mode (set by any MIDI volume messages (CC 7) received while in Program Mode).

Pan

You can set an initial pan position (the balance between the Left and Right audio channels) for the playback and recording of each track as a value between **0** and **127**. A value of **64** is center. If the channel of the Rec Track or the control channel contains any panning events (continuous controller 10), the change will be reflected as the Pan parameter's value in real time, as well as on the MIXER page. Also, changing the Pan value while recording will write Pan automation (CC 10 messages) to the current Rec Track's event list.



Initial Pan Settings

Each song file does not automatically save your Pan setting for each track. To make a song save your Pan settings for each track, you must write an initial Pan value for each track. Initial Pan is the Pan setting that will be used when your song is played back from the start of bar 1. An initial Pan setting is essentially a Pan automation message that is written before the first tick of a track. Initial Pan settings are not automatically written during recording because they make it harder to try out different Pan settings for a track. For example, an initial Pan setting will reset any Pan adjustments that you make during playback each time the song is stopped and played from the start of bar 1, or if the song is stopped and played from any point if the Control Chase parameter set to On on the Song MISC page (see [“The MISC Page” on page 8-17](#)). If you plan to try out different pan positions, it is easier if you write an initial Pan after you have found the desired setting.

Setting Initial Pan Per Track

Follow these steps to change the current Rec Track's initial Pan. While the song is stopped, press the RECORD button, change the value of Pan, press the STOP button, and save the song. Use the same method to quickly set initial program or volume settings. Initial program, pan, and volume can also be set at the top of each track's event list (see [“The EVENT Page” on page 8-36](#)).

Setting Initial Values For All Tracks

An important last step before saving a finished song is to store initial values of Program, Volume and Pan for all tracks. This can be done at any time, but is best done as a last step if you plan to make a lot of adjustments to these settings. To write initial settings for all tracks, press the KEEP soft button on the Song Mixer page (see [“The MIXER Page” on page 8-14](#)). After pressing the KEEP soft button you must save your song to save these settings. Pressing the KEEP soft button stores the current value of each track's Program, Volume and Pan settings as initial settings. Be sure that these values on each track are set to the value that you wish to store, as the settings may have changed if you have written any automation.

Song Mode

The MAIN Page



Note: Don't use the KEEP soft button if you would like certain tracks to not be stored with initial values. In this case, only set initial values for each desired parameter as described above in [“Setting Initial Pan Per Track”](#).

Pan Sources When An Initial Pan Is Not Set

Pan settings are tied to MIDI channels, so the Pan of each track will be dependent on which MIDI channel is assigned to each track in each song. If an initial Pan setting is not stored with each track of a song, the each track will use the last Pan setting set in each MIDI channel. For example, if you are in Song mode and have played a song, and then you load a song without initial Pan settings, the volume of each track of the newly loaded song will be set by the MIDI channel Pan settings in the previously played song. If you are in Song mode and you load a song that does not have initial Pan settings without playing another song first, each MIDI channel will have the Pan settings last used in Program mode (set by any MIDI Pan messages (CC 10) received while in Program Mode).

Locate

The Bar and Beat displayed as the Locate value changes to show the current location of the song during playback and recording. You can set this to a negative Bar and Beat location to start playback a set length of time before the beginning of the song.

Whenever you set the Locate point, that location will be used as the return point when **Stop** is pressed. Press **Stop** a second time will always reset the song to the top (**1 : 1**).

Time In

The Time In parameter determines the start time for Loop or Punch In recording (more on this below).

Time Out

The Time Out parameter determines the stop time for Loop or Punch In recording.

Song End

The Song End parameter determines the end point for the song. Note that when Time Out and Song End are set to the same location, changes made to Song End are reflected in Time Out. When recording beyond your initially specified Song End point, you'll notice that the Song End location automatically moves and rounds to the next bar, so as to always be ahead of the playhead. It is possible to move the Song End point to a location before other MIDI events (i.e., in the middle of the current song)—song mode will ignore (but not delete) events after this point.

Time Signat

Use this parameter to set the time signature of the current song.

Overdub Mode

If Overdub Mode is set to **Merge** you will be able to overdub when recording on a track containing previously recorded events. You'll usually want to set Overdub Mode to **Merge** when Record Mode is set to **Loop**. Otherwise, each time through the loop, the previously recorded information will be erased.

If you set Overdub Mode to **Erase**, the previously recorded events on the record enabled track will be replaced with the new events only during the Bars and Beats you are actually recording, and the previously recorded events before and after the newly recorded Bars and Beats will be preserved.

Record Mode

With the Record Mode parameter set to Linear, Song mode will record normally, from where ever you start, to where ever you stop, or until the Song End point is reached. With the Record Mode parameter set to PunchIn, Song mode will record events only between the points set for Time In and Time Out parameters.

To use the UnLoop setting, the Loop parameter must be set to Loop, and a loop length must be set with the Time In and Time Out parameters. With the Record Mode parameter set to Unloop, any existing tracks will be played back as if they were looping from the Time In to the Time Out point, but they are actually being re-recorded linearly over absolute Bars and Beats until you press Stop. UnLoop allows you to record a linear track over a short looping section without first having to copy the section over and over again to achieve a new desired Song length. The End point of the Song is extended to the downbeat of the (empty) Bar immediately following the last Bar you were recording when Stop was pressed.

For example, let's say you have a recorded a four bar drum loop and now want to record an eight bar bass line. This would be a situation where UnLoop would come in handy. While the drum track keeps looping, the bass track will record in linear fashion, and the end point will be moved to the point at which you press Stop. Actually, the drum track will also change. It will play through its loop twice, but while the information is repeating in the loop, it will be recorded to the track. So now if you look at the drum track, you will see information in bars 5-8 (a duplicate of the information in bars 1-4).

Loop

With the Loop parameter set to On, the sequencer will loop the segment of the song between Time In and Time Out. Set Loop to Off for regular playback.

Metronome

The Metronome parameter determines the recording modes in which the metronome will play. With Metronome set to **Off**, the metronome doesn't play at all. With Metronome set to **Rec**, the metronome only plays while recording is in progress. With Metronome set to **Always**, the metronome plays during playback and recording. With Metronome set to **CountOff**, the metronome plays only during count off (if the **CountOff** parameter on the Metronome page is set to something other than **Off**.)

FX Track

The FX Track parameter determines which track's Program will provide the Aux FX Chains for the song (used by all MIDI channels). The program in the selected FX Track determines the Aux Chains of the current song (unless an override chain is selected). See [“The FX Page” on page 8-22](#) for details on Song Mode FX.

Activity

The Activity row shows the MIDI activity for each track. Track Activity Indicators appear above Track numbers for tracks that contain events and have a Track Status Indicator set to **Play** (P) or **Mute** (M). Track Activity Indicators are small squares with a colored circle in the middle. During playback and recording, the circle will flash when any MIDI events are executed.

When the Overdub Mode parameter is set to **Merge**, the circle in the square will turn red for any track that has the Track Status Indicator set to record (R) .

When the Overdub Mode parameter is set to **Erase**, the circle in the square will turn gray for any track that has the Track Status Indicator set to record (R) .

Track Status

The Track Status row can be used to view and set the track status for each of the 16 tracks. Tracks 1-16 are arranged in left to right order. Possible track status settings are: Empty (–), Record (R), Play (P), and Mute (M).

The Track Status row is most useful for muting previously recorded tracks, or arming multiple tracks when recording to more than one track at a time. When recording a single track, you may find it easier to use the Rec Track parameter to arm a single track at a time.

When an empty track (–) is selected, you can change the status to Record (R) by using the Alpha Wheel or **Plus/Minus** buttons.

Once a track contains events, it will have (P) as a Track Status, and it will be played during playback. You now will be able to toggle between Play (P), Mute (M), and Record (R).

The track selected as the Rec Track will display an (R), designating it as the recording track. If the Rec Track is set to **Mult**, the status of all empty tracks will change to Record (R), and any track can be changed back to empty (-) , mute (M), or Play (P) if recording is not desired on some tracks.

Channel

Each track has a MIDI Channel that it uses to receive and transmit events. By default, tracks 1–16 of a new song are assigned to Channels 1–16 respectively, although a track can play or record on any channel and the same channel can be used for more than one track. Keep in mind, however, that only one program can be assigned to a channel at a time, so if you have more than one track assigned to the same channel, they'll play the same program—the one on the higher-numbered track, since that's the most recent Program Change command received on that channel.

Drum Track

Any of the song's tracks can be defined as a Drum Track so that their Note events do not get transposed if transposition is applied when using the track as a riff in a Multi (see [“RIFF Page” on page 7-31](#) and [“Transpose, Root Note” on page 7-32](#)). With tracks designated as drum tracks, you can transpose a whole song that is being used as a Riff, but the drum tracks will continue to play the correct sounds that they played in the original key. Otherwise, the drum sounds would change with each transposition.

With the desired track number selected in the Drum Track field, use the Alpha Wheel or - /+ buttons to toggle between “Y”, to designate the track as a drum track, or “N” to designate the track as a non-drum track.

The Drum Track settings do not have any effect on edits made in Song Mode. Any tracks defined as Drum Tracks are still transposed when a transposition is applied to these tracks from the TRACK page.

Song Mode

The MIXER Page

The MIXER Page

The Mixer page shows the current settings for the Program number, panning, volume, MIDI destination, and Output selection each track (in groups of 8). The selected track number is displayed in the upper right-hand corner of the screen. Use the CHANNEL/LAYER/ZONE/TRACK or cursor buttons to change the currently selected track. To view each group of tracks, press the 9-16 or 1-8 soft button.

Track	1	2	3	4	5	6	7	8
Pan	64	64	64	64	64	64	64	64
Vol	127	127	127	127	127	127	127	127
Prog	1	9	14	261	50	102	611	851
Out	Auto	Auto	Auto	Auto	Auto	Auto	Auto	Auto
Dest	L--	L--	L--	L--	L--	L--	L--	L--

Pan, Vol, Prog

Use the Pan, Vol, and Prog parameters to view or change the Panning (left/right stereo placement), Volume, or Program of each track. Pan values range from 0 (left), 64 (center), to 127 (right). Volume values range from 0-127.

Pan/Vol Initial Values

Initial values are used to recall each track's settings whenever a song is loaded. Initial values for each track can be seen at the top of the Event page.

When recording to an unused track, the track's Pan and Vol parameters will have an initial value of "none". An initial value of "none" allows you to try different Pan and Volume settings for the track, without having the track return to specific initial values.

Once you have decided on the Pan and Volume settings for the track, you should apply these settings as initial values so that they will be recalled the next time the song is loaded. To set initial values, make sure the song is stopped, press the RECORD button to change the song status to Rec Ready, select the desired initial values again (even if they are already selected), then press the RECORD button again to change the song status to Stopped. Make sure to save these initial values by saving the song before exiting song mode or selecting another song.

Once you have set initial values, if you change the values of Pan or Vol while the song is playing (but not recording), they will return to the initial values if the song is paused/stopped and played again. This allows you try out different settings without losing your initial values.

Prog Initial Values

When recording to an unused track, the track's currently selected Prog setting is written into the header of the track as the initial Program. The initial Program is used to recall each track's Program whenever a song is loaded. The initial Program for each track can be seen at the top of the Event page.

If you change the value of Prog while the song is playing (but not recording), it will return to the initial Program if the song is paused/stopped and played again. This allows you try out different Programs without losing your initial Program setting.

To change the initial Program after you have recorded to a track, make sure the song is stopped, press the RECORD button to change the song status to Rec Ready, select a different Program, then press the RECORD soft button again to change the song status to Stopped. Make sure to save the initial Program setting by saving the song before exiting song mode or selecting another song.

Pan, Vol, and Prog Automation

Pan, Vol, and Prog settings can be automated to change automatically while a song is playing. You can simply change these values in real-time while a track is recording, or use the Event page to insert and edit Pan (CTRL 10), Volume (CTRL 7), and Program Change (PCHG) messages.

Dest

The destination of each track can be set with the Dest parameter. You can choose between combinations of the four possible destinations:

L = Local. The track's MIDI events will be transmitted locally only, to the PC4's internal sound generator. None of the track's MIDI events will be sent to the USB or MIDI Out port.

M = MIDI. The track's MIDI events will be transmitted only to the MIDI Out.

U = USB MIDI. The track's MIDI events will be transmitted only to the USB port.

— = None.

Out

Use the Out parameter to set the rear panel audio outputs (A or B) used for each track of the current song. This parameter determines the output settings for the main program signal and insert effects of each track (for Aux effects output settings, use the Output parameters on the Song Mode FX page.)

A setting of Auto will make that track output audio based on the settings for the program used by that track. Program output settings are set in the Program Editor using the Output parameters on the FX page or Layer FX page (see [“Output” on page 3-14](#) for details).

The KEEP Soft Button

Press the KEEP soft button to view the Keep dialog, which allows you to capture the current values for each track’s program, panning, and volume as the initial values. After using the Keep dialog, remember to save the song if you want these changes to be permanent.

If you don’t use the Keep dialog, tracks will not have initial program, panning, and volume values unless they are manually set for each track. See the Vol, Pan, Prog section above for details on manually setting initial values for each track.



Note: Don’t use the KEEP soft button if you would like certain tracks to not be stored with initial values. In this case, only set initial values for each desired parameter as described in [“Setting Initial Volume Per Track”](#).

The DONE Soft Button

Press the DONE soft button to return to the song MAIN page.

The MISC Page

The MISC page contains miscellaneous sequencer parameters. The MISC page appears below:

MODE:Song Misc			
Control Chase	On	Key Wait	Off
Quantize	Off	Grid	1/8
Swing	0%	Release	No
Metronome	Rec	Count Off	1 Start Only
Program	2044 Click Track		
Channel	16		
Strong Note	C#7	Soft Note	D 7
Strong Velocity	127	Soft Velocity	100
Max Events	110000	Used Events	62
Free Events	109938	PartitionedEvents	140
Song Events	0	Temp Events	0
◀ MORE MAIN MIXER MISC NEW SONG MORE ▶			

Quantize and Miscellaneous Parameters

Control Chase

A common shortcoming of many sequencers is that when you start a sequence at some point in the middle of sequence, the controllers remain at their current levels until the sequencer comes across a controller event. Control Chase remedies this (generally) undesired behavior.

When Control Chase is On, all non-note MIDI events from the beginning of the song up to the current time are computed, and the most recent non-note MIDI event is sent out before starting playback. This ensures that the volume, panning, program changes, and other controllers for the song are correct, regardless of where you start the song. With Control Chase set to Off, the sequencer behaves as previously described.

Key Wait

With Key Wait set to on, a key strike will trigger playback of a sequence (if the play/pause button is armed), or trigger recording of a sequence (if the record button is armed.)

Quantize

The Quantize parameter determines the amount of real-time quantization (if any) applied to the sequence during recording. The percentage specified for this parameter is the amount of quantization the sequencer applies to the grid (see below) for each Note event recorded.

Note that using real-time quantization has the same effect as recording normally, and then using the Quantize Track Editing operation.

Song Mode

The MISC Page

Grid

The grid parameter determines the resolution of quantization and the position of the grid points.

Swing

The Swing parameter determines the amount (in units of percent) of “swing” applied during quantization.

Release

The Release parameter determines whether or not note-off events are quantized.

Metronome Parameters

Metronome

This parameter determines the recording modes in which the metronome plays. With Metronome set to Off, the metronome never plays. With Metronome set to Rec, the metronome only plays during recording. With Metronome set to Always, the metronome plays during playback and recording. With Metronome set to CountOff, the metronome plays only during count off (if the CountOff parameter is set to something other than Off.)

Count Off

This parameter determines the number of measures the PC4 will count off before recording. With Start Only selected, the PC4 will only count off at the beginning of a sequence. With Always selected, the PC4 will count off from any point in a sequence.

Program

This parameter determines the program with which the metronome is played.

Channel

This parameter determines the MIDI channel to which the metronome program and events are sent.

Strong Note

This parameter determines the MIDI number of the note played by the metronome for the first beat of each measure.

Strong Velocity

This parameter determines the velocity of the note played by the metronome for the first beat of each measure.

Soft Note

This parameter determines the MIDI number of the note played by the metronome for all beats other than the first beat of each measure.

Soft Velocity

This parameter determines the velocity of the note played by the metronome for all beats other than the first beat of each measure.

Event Statistics

An Event is a note, CC message, or other MIDI message that can be recorded into the tracks of a PC4 song. Each song in the PC4 can use up to 50,000 Events. Some of these Events may also be used by functions such as Riffs or the Compare Song buffer. 50,000 Events is more than enough for most songs, and most users will never run out of events. In the rare case that you run out of events in the current song, the Event Statistics can be used to determine which functions are using Events.

When calculating Event Statistics, a pair of note-on and note-off events are considered a single event. All other events are stored as single events on the PC4. The Event Statistics fields are:

- **Max Events:** The maximum number of notes/events in memory.
- **Free Events:** The number of notes/events that are free.
- **Song Events:** The total number of events (including notes) in the current song.
- **Used Events:** The total number of notes/events being used.
- **Partitioned Events:** The number of partitioned events, which are events for which space in memory is allocated.
- **Temp Events:** The total number of events in the temp buffer (the temp buffer is used when grabbing events from a different song).

Soft Button Functions

NEW SONG

Press the NEW SONG soft button to create a new song with default settings. Pressing this button is the same as selecting 0*New Song*. See [“Default Song” on page 9-14](#) for details on making custom settings for the default song.

DELETE

Press the DELETE soft button to view the Delete dialog, which allows you to delete the current song.

The FILTER Page

On the FILTER page you can specify what events are ignored during recording and playback. The Event Filter page has two sets of the same parameters. Use the Record Filter parameters to configure recording event-filtering, and the Playback Filter parameters to configure playback event-filtering. (Be careful not to confuse the Event Filter page with the Event List Filter page, which has a different function and is accessed from the EVENT page).

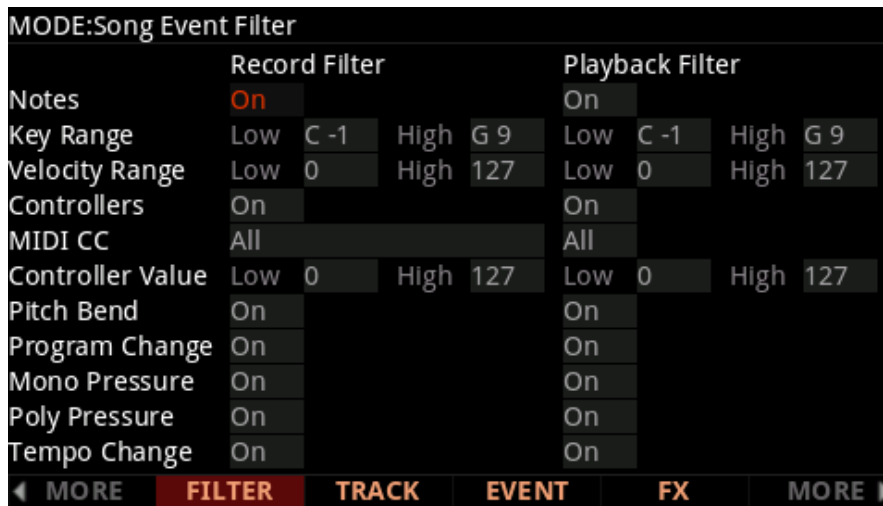

Notes

With Notes set to Off, all notes are ignored during recording/playback. With Notes set to On, only the notes within the specified note range with velocities within specified velocity range are recorded/played.

Key Range Low / High

Key Range Low and High determine the lowest and highest keys that will be recorded/played back when Notes is set to On.

Velocity Range Low / High

Velocity Range Low and High determine the lowest and highest note on/off velocity that will be recorded/played back when Notes is set to On.

Controllers

With Controllers set to Off, all controllers are ignored during recording/playback. With Controllers set to On, only events from the specified controller within the specified value range are recorded/played.

MIDI CC

The MIDI CC parameter determines which controllers are recorded/played back when Controllers is set to On.

Controller Value Low / High

Controller Value Low and High determine the lowest and highest controller values that will be recorded/played back when Controllers is set to On.

Pitch Bend

This parameter enables/disables pitch bend events to be recorded/played back.

Program Change

This parameter enables/disables program changes to be recorded/played back—this includes Controllers 0 and 32 (bank change).

Mono Pressure

This parameter enables/disables monophonic key pressure events to be recorded/played back.

Poly Pressure

This parameter enables/disables polyphonic key pressure events to be recorded/played back.

Tempo Change

This parameter enables/disables tempo change events to be recorded/played back.

Song Mode

The FX Page

The FX Page

The Song mode FX page works the same way as the FX page in Multi Edit mode, with the following exception: Song Mode does not have an AuxFX Ch parameter. Instead, in Song Mode the Aux 1 and 2 Chains are determined by the “FX Track” parameter on the Song Mode MAIN page (see [“FX Track” on page 8-12](#) for details). The program in the selected FX Track determines the Aux Chains of the current song (unless an override chain is selected). See [“FX Page” on page 7-27](#) for details.

The screenshot displays the Song Mode FX page interface. At the top, it shows 'MODE: Song FX' and '11/12 Units'. Below this is a table with 16 channels. The 'Enable' row shows 'Y' for channels 1-3 and '(Y)' for channels 4-16. The 'Aux1%' and 'Aux2%' rows show '[p]' for all channels. Below the table are settings for 'AUX1' and 'AUX2'. 'AUX1' has 'Override Yes', 'Chain' set to '25 Basic Delay 1/8', 'Mod Override' set to 'None', and 'Output' set to 'Auto'. A 'D Delay' button is visible. 'AUX2' has 'Override No', 'Mod Override' set to 'None', and 'Output' set to 'Auto'. At the bottom, there are navigation buttons: 'MORE', 'FILTER', 'TRACK', 'EVENT', 'FX' (highlighted in red), and 'MORE'.

Chan	1	2	3	4	5	6	7	8	9	10	11	12	13	14	15	16
Enable	Y	Y	Y	(Y)	(Y)	(Y)	(Y)	(Y)	(Y)	(Y)	(Y)	(Y)	(Y)	(Y)	(Y)	(Y)
Aux1%	[p]	[p]	[p]	[p]	[p]	[p]	[p]	[p]	[p]	[p]	[p]	[p]	[p]	[p]	[p]	[p]
Aux2%	[p]	[p]	[p]	[p]	[p]	[p]	[p]	[p]	[p]	[p]	[p]	[p]	[p]	[p]	[p]	[p]

AUX1 Override Yes Chain 25 Basic Delay 1/8
Mod Override None Output Auto
D Delay

AUX2 Override No
Mod Override None Output Auto
D Delay

← MORE FILTER TRACK EVENT FX MORE →

The TRACK Page

Use the Track Functions page to perform track-based edit functions such as Erase, Copy, Bounce, Insert, Delete, Quantize, Shift, Transpose, Grab, Change, and Remap.

For each function, there is a set of parameters to control how the function operates, and on what region of the selected track(s). The top right corner of the page displays the selected track or tracks. Use the CHANNEL/LAYER/ZONE/TRACK buttons to select the desired Track(s). Press both of the CHANNEL/LAYER/ZONE/TRACK buttons simultaneously to select All tracks.

Below is an example of the TRACK page for the Bounce function.



Use the parameters on the right side of the page to select the range of time and the type of events that you wish to edit. Different event parameters may be available for each function. For example, Quantize and Transpose apply only to notes, while Remap applies only to Controllers.

The Locate parameter is always positioned on the bottom left of the page.



Note: Before using any of the track functions, it is a good idea to save your song if you have previously made any unsaved changes that you would like to keep. After applying a track function, there is no way to undo the changes, but if you have a previously saved version of the song, you can revert to the previously saved version by selecting another song, selecting No when asked to save changes, then selecting the desired song again.

Once you've chosen a function and set the parameters to your liking, press **Go**. This executes the editing function. You can then play the sequence to hear the results of your edit. If you don't like your edit, simply select another song and press **No** when you are asked if you want to save. If you do like the changes you have made, press the **Save** button and save the song.

Common Parameters for Track Functions

Locate

This parameter is available for every function on the TRACK page. It appears at the lower left hand corner of the page.

The Locate bar, beat, and tick will change in real time during playback and recording to reflect the song's current position. It can be set to any bar, beat, and tick. Playback begins at this position, and Stop resets the song to this position.

From and To

From and To are available in most TRACK edit functions to define a range of time on the selected track(s). The From value defines the first bar, beat, and tick in a range of time selected for editing. The To value defines the final bar, beat, and tick in a range of time selected for editing.

Events

Use the Events parameter to select the type of MIDI event to edit. Available Event types are: All, Notes, Velocity, Controllers, MonoPress, PitchBend, ProgChange, PolyPress. Some event types are available only for certain Functions.

When Events is set to All, all MIDI events on the track(s) you are editing that occur in the region of time between the From and To settings will be affected by the edit function.

When Events is set to Notes, note number and velocity ranges can be set for Note events. (Some Functions may not provide velocity range parameters).

When Events is set to Velocity, the velocity range can be set for Note events.

When Events is set to Controllers, the Controller and Value Range can be set for Controller events.

Key Range

The left and right Key Range fields respectively determine the lowest and highest notes in a range of notes that will be affected by the selected Track Function.

Velocity Range

The left and right Velocity Range fields respectively determine the lowest and highest velocities in a range of velocities that will be affected by the selected Track Function.

Controller

The Controller parameter selects the Controller (or All Controllers) to be affected.

Value Range

The left and right Value Range fields respectively determine the lowest and highest values in a range of MIDI Continuous Controller (CC) values that will be affected by the selected Track Function.

Soft Buttons on the TRACK Page

FROM TO is a quick way to define the region of time you intend to edit. There are a couple of ways to use this feature while a song is playing, and both ways will set the boundaries of the region.

One way is to select the From parameter and then press the Play button. During playback, every time you press FROM TO, the PC4 updates the value of From with the current playback location. Select the To parameter to change the value of To in a similar fashion.

If you haven't selected either the From or To parameter, pressing FROM TO during playback updates From or To—or both—depending on the current playback location (the value of the Locate parameter) at the time you press FROM TO. If you press it while the Locate value is earlier in the song than the current To value, the PC4 updates the From value. If you press FROM TO again (without stopping playback) while the Locate value is later than the current From value, the PC4 updates the To value.

GO performs the selected Function.

DONE will return you to the Song Mode Main page.

Track Functions

Erase

This function erases specified events from a region of time, but it doesn't delete the region of time. The result is like erasing a section of recording tape. If you want to completely remove a segment and shorten the length of the track, you can do it with the Delete function.



Song Mode

The TRACK Page

Copy

Use the Copy function to duplicate the selected events from the current track and place them in the same track or on another track, either merging with or overwriting existing events.

MODE:Song Track Functions			Track:1			
Function	Copy	From	1	1	0	
Destination Track	1	To	2	1	0	
Location	1 1 0	Events	Notes			
Mode	Merge	Key Range	C -1	G 9		
Times	1	Velocity Range	0	127		
Locate	1 1 0					
FROM-TO			PLAY	STOP	GO	DONE

If you do not want to copy all of the MIDI events in the defined range of time on the current track, use the Events parameter to select a specific MIDI event type you would like to copy.

Destination Track: 1 to 16 / All

Select a destination track for the copied events with the **Destination Track** parameter. Copied events will be placed in the destination track(s) at any Bar and Beat you specify.

If the currently selected track is All tracks then the destination track will be All tracks as well.

Location: Bars : Beats : Ticks

Use the Location parameter to specify a bar, beat, and tick location in the destination track where the copied events will be placed. If the length of the copied region extends from the Location point beyond the song's existing End point, a new End point is defined.

Mode: Merge/Erase/Slide

The Mode setting determines whether the copied events merge with, or erase existing events on the destination track from the location point to the end of the copied region. With Mode set to Slide, the sequencer creates space for the new events, and slides the existing events to uniformly later times in the song.

Times: 1 to 127

The value selected for the Times parameter determines how many copies of the selected region are placed, one after another, in the destination track.

Bounce

Use the Bounce function to move the selected events from the current track to another track, either merging with or overwriting existing events on the destination track. The Bounce function differs from the Copy function in that events on the source track are deleted. As on a multi-track tape recorder, Bounce will always put the copied events at the same place in time on the Destination Track that they were on the source track.

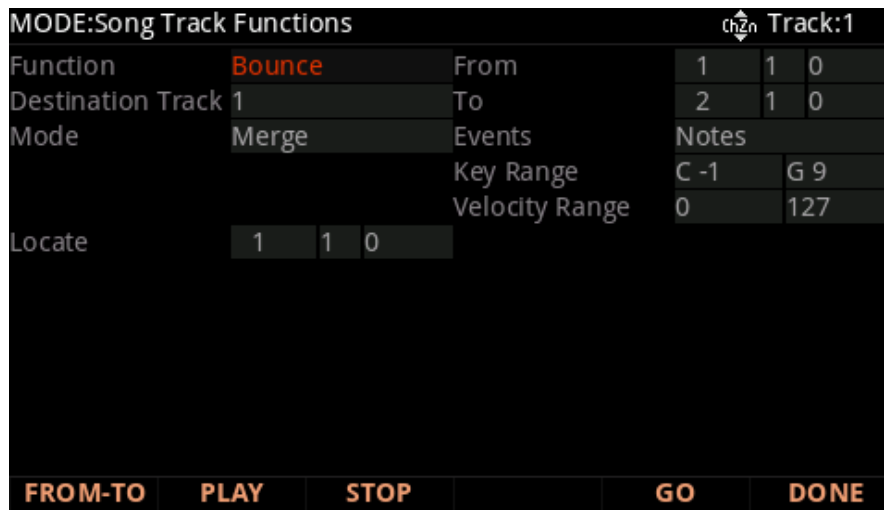

Destination Track: 1 to 16

Select a destination track for the bounced events with the **Destination Track** parameter. Bounced events will be placed in the destination track at the events' original location.

Mode: Merge/Erase

The Mode setting determines whether the bounced events merge with, or erase existing events on the destination track from the location point to the end of the bounced region.

Song Mode

The TRACK Page

Insert

The Insert function is used to add blank time to the current song, modifying the song's End point appropriately. The Insert function will affect all tracks. This is similar to splicing a piece of blank tape to an existing segment of recording tape.

MODE:Song Track Functions				Track:All	
Function	Insert				
Location	1	1	0		
Amount	1	0	0		
Locate	1	1	0		
FROM-TO		PLAY	STOP	GO	DONE

Location: Bars : Beats : Ticks

Use the Location parameter to specify a bar, beat, and tick location in the destination track where the blank time will be inserted. Events that occur on or after this Bar and Beat are offset by the length of the blank time being inserted.

Amount: Bars : Beats : Ticks

Use the Amount parameter to set the number of blank Bars, Beats, and ticks to insert.

Delete

The Delete function is used to remove a region of time from the current song. This function is different from the erase function because not only does it remove the events from the selected time, it will delete the entire selected range of time from the song, modifying the song's End point appropriately (on all tracks). This is similar to cutting a section out of a tape and splicing the ends.



Song Mode

The TRACK Page

Quantize

Use the Quantize function to adjust the timing of Note events. Keep in mind that only Note events are quantized; other types of events, such as controllers, are not quantized.

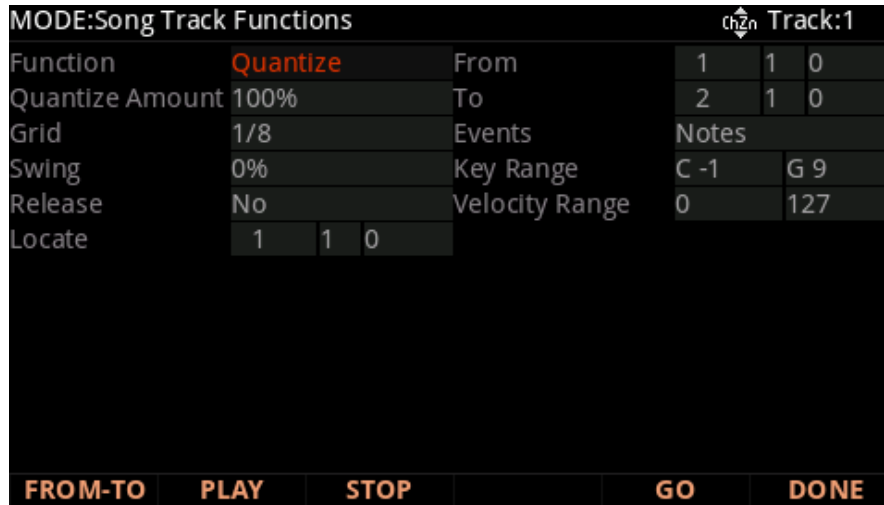

Quantize Amount: 0 to 100%

The Quantize Amount parameter determines how much the selected Note events are moved towards grid locations. For example if set to **100%**, notes will be moved to the closest grid location, defined by the Grid setting. If set to **50%**, notes will be moved to a position half way between the closest Grid location and the original note location.

Grid: 1/1 to 1/480

This setting determines the size of the Quantize grid, expressed as a fraction of a Bar with a 4/4 meter. Set Grid to **1/1** for whole note grid, **1/16** for sixteenth notes. All of the standard note durations and every fractional Bar divisions in between are available as the size of the Quantize grid.

Swing: -100 to 125%

The Swing percentage is applied to the quantize grid. **0%** swing is straight time, **100%** produces a swing feel (triplet feel). A positive Swing value determines how close every other grid location is moved to a point 1/3 of the way towards the next grid point. Negative Swing moves every other grid location closer to a point 1/3 of the way towards the previous grid point.

Release: Yes/No

The Release parameter determines whether Note Off events will be quantized, in addition to Note On events.

Shift

The Shift function allows you to offset the existing MIDI events forward or backward in time any number of bars, beats and ticks. Events can not be shifted before Bar 1 : Beat 1 : Tick 0.

MODE:Song Track Functions			Track:1		
Function	Shift		From	1	1 0
Amount	1	0 0	To	2	1 0
Mode	Merge		Events	Notes	
			Key Range	C -1	G 9
			Velocity Range	0	127
Locate	1	1 0			
FROM-TO			PLAY		
STOP			GO		
			DONE		

Amount: Bars : Beats : Ticks

The Amount parameter specifies the number of bars, beats, and ticks that the selected MIDI events are moved forward or backward in time.

Mode: Merge/Erase

The Mode setting determines whether the shifted events merge with or erase existing events.

Song Mode

The TRACK Page

Transpose

Use the Transpose function to change the MIDI Note numbers of the selected Note events.

MODE:Song Track Functions		Track:1			
Function	Transpose	From	1	1 0	
Semitone	2ST	To	2	1 0	
		Events	Notes		
		Key Range	C -1	G 9	
		Velocity Range	0	127	
Locate	1 1 0				
FROM-TO		PLAY	STOP	GO	DONE

Semitone: -128 to 127 semitones

An increment of one semitone represents a change of one MIDI Note number. You can transpose Note events only within the range of MIDI Note numbers 0 to 127.

Grab

Grab is similar to the Copy function, except that the Grab function allows you to copy selected events from tracks that exist in other songs in memory.

MODE:Song Track Functions			Track:1		
Function	Grab		From	1	1 0
Source Song	1 New Song		To	2	1 0
Destination Track	1		Events	Notes	
Location	1	1 0	Key Range	C -1 G 9	
Mode	Merge		Times	1	
Locate	1	1 0			
FROM-TO			PLAY		
STOP			GO		
			DONE		

Source Song: Song List

Use the Source Song parameter to select a song to Grab. The source track is determined by the Track parameter displayed on upper right hand side of the page, selectable with the CHANNEL/LAYER/ZONE/TRACK buttons.

Destination Track: 1 to 16/All

Select a destination track for the grabbed events with the Destination Track parameter. All selected events from the source song and track will be placed in the destination track(s) at the bar, beat, and tick you specify.

If the currently selected track is All tracks then the destination track will be All tracks as well.

No matter what channel the current track (source track in the source song) is set to when you use the grab function, the events will be played on the destination track's channel.

Location: Bars : Beats : Ticks

Use the Location parameter to specify a bar, beat, and tick location in the destination track where the grabbed events will be placed. If the length of the grabbed region extends from the Location point beyond the song's existing End point, a new End point is defined.

Mode: Merge/Erase/Slide

The Mode setting determines whether the grabbed events merge with, or erase existing events on the destination track from the location point to the end of the grabbed region. With Mode set to Slide, the sequencer creates space for the new events, and slides the existing events to uniformly later times in the song.

Song Mode

The TRACK Page

Times: 1 to 127

The value selected for the Times parameter determines how many copies of the selected region are placed, one after another, in the destination track.

Change

The Change function is used to modify existing velocities, controller events, or other MIDI events on the current track. A static change of values can be made as well as having the change take place over a region of time.



Scale: 0% to 20000%

Use the Scale parameter to multiply the selected event values by percentage. Values can be scaled from 0% to **20,000%**.

Offset: -128 to 127

Offset can be used alone or in conjunction with Scale to add or subtract a set amount to or from the original (or scaled) values. Values for velocities can not be less than 1 or greater than 127. Values for controllers can not be less than 0 or greater than 127.

For example, to set all Velocities to a value of 55, you would set Scale to **0%** (multiplies all original values by zero) and set Offset to **55** (adds 55 to the product of the Scale parameter).

Mode: Constant/PosRamp/NegRamp

Set Mode to **Constant** to have values modified in a uniform fashion, as determined by the Scale and Offset settings, for the entire selected region of time and range of values.

When the Change function is applied with Mode set to **PosRamp**, the selected velocity or controller values will gradually change over the region of time, defined by the locations set for the From and To parameters, from the original value to the new value determined by the Scale and Offset settings. The first events being modified within the region will have little or no change from their original values. The amount of Scale and Offset applied will increase as the song approaches the Bar and Beat defined in the To parameter, where the full amount of Scale and Offset will be applied.

You can set Mode to **NegRamp** to achieve the opposite dynamic effect of **PosRamp**. **NegRamp** works in the same way, but the amount of Scale and Offset applied will decrease from the full amount to little or no change as the song approaches the bar, beat, and tick defined in the To parameter.

Remap

Use the Remap function to apply values from existing controller events to another controller number.



Old: Controller List (0 to 120)

Use the “Old” parameter to select the Controller that you wish to remap. This Controller must already have events on the current track in order to apply it to the “New” Controller type. The old events will be deleted.

New: Controller List (0 to 120)

Use the “New” parameter to select the Controller that will use the existing values from the “Old” Controller.

The EVENT Page

The EVENT page allows you to view, modify, add, or delete any MIDI event on each track. Every type of recorded MIDI event is visible from this page. You can also access the tempo track.

The top line of the page displays the current song location in the center, and the currently selected track and corresponding channel on the right. Use the CHANNEL/LAYER/ZONE/TRACK buttons to select a track. Each track displays its initial program, volume, and pan at the top of its event list.

The screenshot shows the 'EVENT' page interface. At the top, it displays 'MODE: Song Event', the current song location '1:3:0948', and the selected track 'Track:2 (Ch 2)'. Below this is a table of MIDI events with columns for 'START', 'Program', '1 Dyn', '9ft', 'Grand', 'Vol', and 'Pan'. The first event is highlighted in red. Below the table is a piano roll visualization showing notes on a keyboard across 7 octaves. At the bottom, there are buttons for 'CUT', 'COPY', 'PASTE', 'NEW', 'FILTER', and 'DONE'.

START	Program	1 Dyn	9ft	Grand	Vol	Pan
1:1	1	1	0003	CTRL Express	127	64
1:3	1	3	0948	NOTE C 3 vAt 118 vRI 72	Len 0	0 506
1:3	1	3	0948	NOTE C 4 vAt 109 vRI 88	Len 0	0 592
1:3	1	3	0950	NOTE F 3 vAt 104 vRI 73	Len 0	0 524
1:3	1	3	0952	NOTE F 1 vAt 104 vRI 56	Len 0	0 520

To scroll through the events, make sure the location (Bar and Beat, in the left column) is highlighted. Use the Alpha Wheel, the **Up** and **Down** cursor buttons, or the **Plus/Minus** buttons. As you scroll through the events, each event is executed by the sequencer. In the case of Note events, you will hear the note played, although the duration will be short. If you have scrolled through a Sustain (CTRL 64) message with a value of 127 then you will hear the note sustain as if the sustain pedal was depressed. The note will continue to sustain until you scroll through a Sustain message with a value of 0.

You can also jump directly to a specific bar and beat by typing the bar number and beat number, then pressing **Enter**. Keep in mind if you have controller or program events previous to the point that you jump to, those events may not have been executed and you may hear unexpected results. For example, if you have program changes at bar 1 and bar 8, and you jump from bar 1 to bar 9, any notes you scroll through will be played with the program change from bar 1.

The bottom half of the page displays notes from the current track, graphically represented as squares spread out over 7 octaves of a keyboard. The currently selected note in the list will be shown as a red square.

Initial Program, Volume, Pan

At the top of the event list for each track, you can view and change the initial program, volume and pan settings for the current track. Initial values are needed in order for songs to sound correct after being saved and recalled. If you do not want initial values, each of these parameters can be set to NONE by entering -1 on the alphanumeric pad and then pressing the Enter button.

Location

The first column represents the Bar and Beat Locations of the different events in a song. Scroll through the events on the selected track(s) with the Alpha Wheel or type a specific Bar and Beat on the alphanumeric button pad to jump to events occurring on that Beat. A quick way to jump to the End point in a track is to press **9999** and then **Enter** on the alphanumeric button pad.

Bar, Beat, and Tick

Bar, Beat, and Tick are editable parameters for each event. They determine when an event happens relative to the other events within the song. Tick can be set from 0 to 959. See [Beat Subdivisions in Ticks on page 8-39](#) for a list of beat subdivisions in ticks.

Event Type and Value

The Event Type and Value region displays the MIDI event type (and related information) at each Event-list location in the song. Different event types display different kinds of information, and have different editable values.

The event type is the left-most field. You can highlight this field and change the event type. MIDI note events are denoted by a “NOTE” followed by the note name. To change the note, highlight the note name, use the Previous/Next buttons, Alpha Wheel, or Type a note number (0-127) and press Enter. You can also hold the Enter button and play the desired note on the keyboard.

This table lists the available event types and value ranges:

Event Type	Values	
Program Change (PCHG)	0 to 127	
Pitch Bend (BEND)	-8192 to 8191	
Mono Pressure (MPRS)	0 to 127	
Poly Pressure (PPRS)	0 to 127	C -1 to G 9
MIDI Note Events (NOTE)	Note events have four editable values: Note Name/Number, Attack Velocity (indicated by a “vAt”), Release Velocity (indicated by a “vRI”), and Note Length (Len).	
	Note Name/Number	C -1 to G 9
	Attack Velocity (vAt)	0 to 127
	Release Velocity (vRI)	0 to 127
	Note Length (Len)	Bar : Beats : Ticks
MIDI Controller Events (CTRL)	Controller events have two editable values: Controller Type and Controller Value. Defined controllers are referred to by their names.	
	Controller Type	Control Source List (0 to 127)
	Controller Value	0 to 127
Tempo Change (TEMPO)	20.00 BPM to 400.00 BPM	

Soft Buttons on the EVENT Page

CUT: Removes the currently selected event from the Event list and temporarily stores it in a memory buffer so that you can immediately paste it into a new location.

COPY: Makes a duplicate of the currently selected event and temporarily stores it in a memory buffer so that you can immediately paste it into a new location.

PASTE: Inserts the most recent cut or copied event into the Event list at the currently selected Bar : Beat : Tick location. The pasted event will share the same location with the event that already existed at that location in the Event list, but it will appear before the pre-existing event.

NEW: Inserts a new event by duplicating the current event.

FILTER: View the Event List Filter page, which allows you to show and hide specific types of events in the event list for easier navigation. This does not affect which events are played back or recorded. The parameters are the same as described in [“The FILTER Page” on page 8-20](#). Unlike the Record and Playback Filter pages, the Event List Filter page has TOGGLE, ALL ON and ALL OFF soft buttons, which respectively sets all On/Off parameters on this page to their reversed states, all On, or all Off.

DONE: Returns to the last viewed Song mode page.

Tempo Track

To access the tempo track, use the CHANNEL/LAYER/ZONE/TRACK buttons to navigate to track 1, then press the CHANNEL/LAYER/ZONE/TRACK down button. The tempo track functions the same as the other tracks, except the only event type available is tempo change.

Beat Subdivisions in Ticks

In song mode, each quarter note is divided into 960 ticks (0-959), which allows for unquantized performances to keep their original nuanced timings. If you wish to find specific quantized beat divisions in ticks, use the table below:

Beat Subdivision		Tick Value
Quarter note	1st	0
8th note	1st	0
	2nd	480
8th note triplet	1st	0
	2nd	320
	3rd	640
16th note	1st	0
	2nd	240
	3rd	480
	4th	720
16th note quintuplet	1st	0
	2nd	192
	3rd	384
	4th	576
	5th	768
16th note triplet (sextuplets)	1st	0
	2nd	160
	3rd	320
	4th	480
	5th	640
	6th	800

Chapter 9

Global Mode

About Global Mode

Global Mode allows you to adjust performance settings which affect all Programs and Multis. Global Mode also allows you to Store, Load, and Delete User objects, or restore factory defaults by performing a Reset.

To enter Global Mode from another Mode, press and turn on the GLOBAL Mode button.

MAIN 1 Page

The MAIN 1 page in Global Mode allows you to adjust global tuning, effects settings, display and navigation settings, and other basic global parameters.



The screenshot shows the 'MODE:Global Main 1' screen with a list of settings. The 'Tune' setting is highlighted in orange. At the bottom, there is a navigation bar with buttons for 'MORE', 'MAIN 1', 'MAIN 2', 'FX', 'FILE', and 'MORE'.

MODE:Global Main 1			
Tune	0 ct		
Transpose	0 ST	Program Tempo	Program
FX Mode	Performance	Sound Selection	Category Buttons
Display	Large	Show Zone Info	No
Show Controllers	Yes	Out Pair B Mode	Normal
AutoPowerOff	On	Audio Out S/M	Stereo
PowerOff Time	8 hours	Multi Controllers	Instant
Song Rechannel	Auto	Blink Tempo	No
Audio In Level	0 dB	LEDs mode	Complete
Audio In FX	No	FM Velocity	0-99

Tune

The Tune parameter allows you to fine-tune the unit in cents—one cent is one hundredth of a semitone (100 cents comprise a semitone). You can select any tuning from -100 cents to 100 cents. By default this parameter is set to 0.

Transpose

The Transpose parameter allows you to tune the pitch of the unit in semitones.

FX Mode

The FX Mode parameter determines how the PC4 responds to interrupts with regards to effects. You can set this parameter to either Performance or Multitrack.

With FX Mode set to Performance, the PC4 minimizes disruption of existing effects when changing Programs, and entry values will not disrupt sustained notes when changing Programs in Program Mode. When controlling the PC4 from an external sequencer in Program Mode, setting FX Mode to Multitrack will minimize effect disruption.

Display

The Display parameter allows you to change the way that Programs and Multis are displayed on the Program and Multi Mode main pages by selecting one of three different “views”.

Large

The default view is Large, which displays the Program or Multi name with large text, along with the category name and background image.

When Large is selected, controller assignments and values can be shown when a controller is moved (Knobs, Sliders, Switch buttons, Wheels, and Pedals). See “Show Controllers” below for details.

Quick Access

Quick Access view shows the names of 10 favorite Programs and/or Multis, which can be selected by pressing the corresponding numbers on the Keypad. (Program/Multi names become smaller when the Show Zone Info parameter is set to Yes.) To access more than 10 Programs/Multis, use the CHANNEL/LAYER/ZONE/TRACK buttons to select a different Quick Access Bank. The current Quick Access Bank number is shown in the top right corner of the display. Programs or Multis which are not stored in a Quick Access Bank can be browsed by using the ALPHA WHEEL or PREVIOUS/NEXT buttons.

When Quick Access view is selected, press and hold one of the Keypad buttons (0 through 9) to store the currently selected Program or Multi to a spot in the current Quick Access Bank. User edited Quick Access Banks can also be renamed, see [“QA Banks” on page 9-27](#) for details.

When Quick Access is selected, controller assignments and values can be shown when a controller is moved (Knobs, Sliders, Switch buttons, Wheels, and Pedals). See “Show Controllers” below for details.



Note: When Quick Access is selected, the Category buttons always select an entry in the current Quick Access bank, despite the state of the KEYPAD button. In Program Mode, when Quick Access is selected, the state of the KEYPAD button determines whether programs browsed by using the ALPHA WHEEL or PREVIOUS/NEXT buttons are ordered based on category order then ID number (KEYPAD off), or based on ID number only and ignoring category (KEYPAD on). In Multi Mode, the KEYPAD button is always on, and Multis are always ordered by ID number only.

List

List view displays the current Program or Multi as a selected item in a list showing the next and previous Programs or Multis.

Show Controllers

When “Large” or “Quick Access” view is selected for the Display parameter (see above), the Program and Multi Mode main pages can briefly show controller assignments and values when a controller is moved. Set this parameter to **No** to hide controller assignments. Set it to **Yes** to briefly show controller assignments when a controller is moved (Knobs, Sliders, Switch buttons, and Wheels, but not Pedals or Pressure). Set it to **Yes (Incl. pedals)** to show all controllers, including Pedals and Pressure.

Auto Power Off

The auto power off parameter turns the power saving feature on. When the Auto Power Off parameter is set to On, the PC4 will automatically power off after the Power Off Time has expired, from the last key press (physical or MIDI), button press, controller movement, or USB MIDI activity.

Power Off Time

If the Auto Power Off parameter is set to On, then the PC4 will power off after the time selected by the Power Off Time parameter has elapsed. The PC4 will display the following warnings before powering off. Press a key or move any PC4 control to dismiss the warning message. After dismissing this message, the PC4 will wait the selected amount of time before showing this warning again.

Song Rechannel

The Song Rechannel parameter determines the behavior of Song mode when recording a Multi into a Song. When Song Rechannel is set to **Auto**, Song mode will automatically set the Rec Track parameter to Mult when recording from Multi mode, which allows multiple tracks to be recorded at once. This is usually the setting you will want when recording a Multi with multiple channels into multiple tracks/channels of Song mode. When Song Rechannel is set to **Manual**, the Song mode Rec Track parameter will not be automatically changed when recording from Multi mode. In this case you must manually set the Song Mode Rec Track and Track Status parameters. This can be useful if you wish to exclude certain Zones/Channels of a Multi from being recorded into a Song when recording an overdub or Punch In. See [Recording A Multi To Song Mode on page 6-11](#) for more details.

Audio In Level

The Audio In Level parameter controls the volume of devices plugged into the rear Audio Input jacks. The default setting of 0dB should work well for most line level sources (such as MP3 players). Adjust this parameter if the Audio Input signal is too quiet or too loud in comparison to the sounds of the PC4.

Audio In FX

Set the Audio In FX parameter to Yes or No to enable or disable audio input effects. The Audio In FX settings on this page apply in Program and Multi Mode. In Multi Mode, these FX settings can be overridden for each Multi by using the Multi Edit Audio In FX page (for details see [Audio In FX \(AUDIO IN\) Page on page 7-41](#)). If a Multi is selected which has its Audio Input Mode set to “Multi Specific Effects”, the Global Mode Audio Input FX settings will be ignored, and the Audio Input FX settings in the Multi will be used instead.

Audio In FX Chain

When the Audio In FX parameter is set to Yes, you can use the Audio In FX Chain parameter to select an FX chain to apply to the rear panel audio input jacks. If you wish to edit a Chain, you can enter the Chain Editor by pressing the EDIT button (see [Ch. 4 The Effects Chain Editor](#) for details).

When selecting an Audio Input Chain, the Chain may steal FX unit resources from other channels if more resources are needed to load the Chain. When stealing occurs, resources in higher numbered channels will be stolen first, and in Program Mode resources in the currently selected channel will be stolen last.

Audio In Control

When the “Audio In Control” parameter is set to “No Real Time Ctl”, the Effects Chain Mods are disabled. Set the “Audio In Control” parameter to “Current Chan Ctl” to enable the Effects Chain Mods of the selected Chain.

In Program Mode, Mods assigned within the selected Audio Input Chain can be controlled by the PC4’s physical controllers. See the About Effects Chain Mods section below for more details.

In Multi Mode, if a Multi is selected which has its Audio Input Mode set to “Use Global Mode Effects”, any Mods assigned within the selected Audio Input Chain can be controlled by controllers assigned in a Zone set to the same MIDI channel as the current setting for the Multi’s “AuxFX Ch” parameter. See the About Effects Chain Mods section below for more details.

About Effects Chain Mods

Effects Chain Mods are modulation controls which can be assigned to the PC4’s physical controllers. For example, an Effects Chain Mod assigned to a Slider can be used to adjust the dry/wet effect mix, or control other parameters like reverb or delay time.

When the “Audio In Control” parameter is set to “Current Chan Ctl”, Mods assigned within the selected Audio In FX Chain can be controlled by controllers sending the same CC numbers from the currently selected Program or Multi.

To view the Mods of the selected Audio In FX Chain, select the Audio In FX Chain field and press the EDIT button to enter the Chain Editor, then go to the Chain Info page (see [Ch. 4 The Effects Chain Editor](#) for details).

Audio Input Mods in Program Mode

To control Audio Input Mods in Program Mode, first make sure the Global “Audio In Control” parameter is set to “Current Chan Ctl”. In Program Mode, the PC4’s physical controllers send the MIDI CC numbers listed in the table below. If the selected Chain contains Mods which use any of these MIDI CC numbers, effects parameters will be controllable by using the physical controllers which have corresponding MIDI numbers.

Use the Chain editor if you wish to add Mods, remove Mods, or change their MIDI assignments. Select the Chain field and press the EDIT button to enter the Chain Editor. See [The MOD Pages on page 4-3](#) for details on editing Chain Mods.

PC4 Physical Controller MIDI CC Numbers

Mod Wheel (MIDI CC 1)	Slider 4 (MIDI CC 23)	Knob 3 (MIDI CC 72)
Knob 8 (MIDI CC 3)	Slider 5 (MIDI CC 24)	Knob 2 (MIDI CC 73)
CC Pedal 2 (MIDI CC 4)	Slider 6 (MIDI CC 25)	Knob 4 (MIDI CC 79)
Knob 9 (MIDI CC 9)	Slider 7 (MIDI CC 26)	Switch 1 (MIDI CC 80)
CC Pedal 1 (MIDI CC 11)	Slider 8 (MIDI CC 27)	Switch 2 (MIDI CC 81)
Slider 1 (MIDI CC 12)	Slider 9 (MIDI CC 28)	Switch 3 (MIDI CC 82)
Slider 2 (MIDI CC 13)	Variation Button (MIDI CC 29)	Switch 4 (MIDI CC 83)
Knob 5 (MIDI CC 14)	Sw. Pedal 1a (MIDI CC 64)	Switch 5 (MIDI CC 85)
Knob 6 (MIDI CC 17)	Sw. Pedal 1b (MIDI CC 66)	Switch 6 (MIDI CC 86)
Knob 7 (MIDI CC 18)	Sw. Pedal 2a (MIDI CC 66)	Switch 7 (MIDI CC 87)
Ribbon Section 1 (MIDI CC 21)	Sw. Pedal 2b (MIDI CC 67)	Switch 8 (MIDI CC 89)
Slider 3 (MIDI CC 22)	Knob 1 (MIDI CC 71)	Switch 9 (MIDI CC 90)

Audio Input Mods in Multi Mode

To control Audio Input Mods in Multi Mode, first make sure the Global “Audio In Control” parameter is set to “Current Channel Control”. On the Multi Edit Controls page, use the Destination field to assign a Multi controller to send the desired FX Mod CC number (see [CONTROLS Page on page 7-13](#) for details). The Zone used to send these CC numbers must have a MIDI Channel which matches the current setting for the Multi’s “AuxFX Ch” parameter. See [Channel on page 7-7](#) and [Aux FX Channel on page 7-28](#) for details.

Program Tempo

When this is set to Program, each program can be saved with a specific tempo, or be set to use the system tempo. Tempo is used for the Arpeggiator as well as Tempo synced LFOs and effects. This is set on the Program Edit Arp page (see [Tempo on page 3-24](#)). Per-program Tempos can also be overridden by selecting System for the Global tempo parameter.

Sound Selection

The **Category Buttons** setting allows you to select Programs and Multis normally.

The **Enter Button** setting allows you to scroll through the Program or Multi list without immediately loading the selected Program or Multi. This allows you to find the next Program or Multi to load without interrupting the Program or Multi that is currently being played. When scrolling through the Program or Multi list, Programs and Multis will appear with their names in parenthesis to indicate that they have not been loaded. Press the Enter button to load the currently selected Program or Multi. When switching to Program or Multi mode, the current Program or Multi will be loaded automatically. When pressing a Quick Access button, the assigned Program or Multi will be loaded automatically.

Show Zone Info

When this parameter is set to **Yes**, the Multi Mode selection page will show information for each of the Zones in the currently selected Multi.

The Multi select page will show information for 4, 8 or 16 Zones at a time, depending on the number of Zones in the selected Multi. If the selected Multi has 4 Zones or less, the Multi select page will show the information below. If the selected Multi has more than 4 Zones, some of this information will not be displayed.

- Zone **Solo** status: The **Solo** icon turns white for any not soloed Zone. The **Solo** icon turns red for any soloed Zone.
- Zone **On** status: The **On** icon turns white for any Zone that is not active (muted). The **On** icon turns green for any Zone that is active (not muted) if it has a MIDI destination which includes LOCAL. The **On** icon turns orange for any Zone that is active (not muted) if it has a MIDI destination which does not include LOCAL.
- Zone **MIDI Output** status: The **MIDI Output** icon has a symbol for USB (on the left) and standard MIDI 5-pin DIN (on the right). This icon changes color depending on the MIDI destination of each Zone. If the Zone has no USB or MIDI output selected for Destination, the icon turns white. If the Zone has USB and/or MIDI selected for Destination, the corresponding left and/or right side of the icon turns green.
- Zone **A B Audio Output** setting: The **A B Audio Output** icon shows the Audio Output setting of each Zone. This icon corresponds with the **Output** parameter on the Multi Edit MAIN page. If Output is set to Auto, both sides of the icon (A and B) turn green. If Output is set to A, the left side of the icon (A) turns green, and the right side (B) turns white. If Output is set to B, the left side of the icon (A) turns white, and the right side (B) turns green.
- Zone **Key Range**: The **Key Range** icon shows an overview of the Key Range settings for each Zone.

- **Zone Program ID number and name:** The **Program ID number and name** of each Zone is displayed.
- **CC7 (MIDI Channel Volume):** The **CC7** icon shows the value of MIDI continuous controller 7 for each Zone's MIDI channel. In each MIDI channel, CC7 controls the overall program output volume. The height of the green bars in the CC7 icon corresponds with the CC7's current value, giving you an overview of the volume of each Zone. For factory Multis, CC7 is assigned to Sliders 1-4 for Zones 1-4.
- **CC11 (MIDI Expression Level):** When the Global Mode Main 1 **Show Controllers** parameter is set to **Yes (Incl. pedals)**, the CC11 icon appears. The **CC11** icon shows the value of MIDI continuous controller 11 for each Zone's MIDI channel. In each MIDI channel, CC11 controls the pre-insert FX program level (also known as Expression Level). The height of the green bars in the CC11 icon corresponds with the CC11's current value, giving you an overview of the Expression Level of each Zone. For factory Multis, CC11 is often assigned to the CC1 pedal.

Out Pair B Mode

The B Audio Outputs can either be used as a second set of stereo (auxiliary) outputs by setting this parameter to “Normal” or they can be used to mirror the main A Audio Outputs by setting this parameter to “Mirror Primary Outputs”. By default this parameter is set to Normal.

Audio Out S/M

The audio outputs are normally used as a stereo pair; however, the PC4 can be operated in Mono mode by plugging an audio cable into the Left “A” Audio Output, and nothing into Right Output. Setting this parameter to Auto allows the PC4 to detect the audio connections and adjust to mono output if required. The parameter can be set to Stereo, to force the PC4 to always output a stereo signal and ignore the audio output detection. By default this parameter is set to Auto.

Multi Controllers

When a multi is selected, this parameter determines how the sliders respond to movement. When set to instant, moving a slider will result in the assigned parameter immediately jumping to the slider position. With some parameters an abrupt change to the sound may be undesirable. In this case set this parameter to PassEntry and the slider will only become active when the Slider is moved past the Multi Entry Value. This results in smooth changes to the sound.

Blink Tempo

When the Blink Tempo parameter is set to Off, the TAP TEMPO button does not blink. When the Blink Tempo parameter is set to On, the TAP TEMPO button will blink in sync with quarter notes of the system tempo.

LEDs Mode

The LEDs Mode parameter controls the LED backlighting for the Alpha Wheel, Pitch Wheel, Mod Wheel and rear panel PC4 logo. Set the LEDs Mode parameter to Complete to turn the LED backlighting on. Set the LEDs Mode parameter to Partial to turn the LED backlighting off.

FM Velocity

The FM Velocity parameter determines how FM layers in Programs respond to note velocity.

When FM Velocity is set to 1-100, FM layers will respond to note velocities 1-127, but will sound as they did in classic FM synthesizers which only transmitted velocities 1-100. This is useful when playing FM layers imported from classic FM synthesizers.

When FM Velocity is set to 1-127, FM layers will respond to note velocities 1-127. This provides more velocity range than classic FM synthesizers; FM layers imported from classic FM synthesizers may sound different (imported FM layers will often sound brighter).

MAIN 2 Page

The MAIN 2 page in Global Mode allows you to velocity and intonation settings, as well as other global controller settings.

MODE:Global Main 2			
Velocity Map	Linear	Key Velocity Map	0 None
Pressure Map	Linear	Press S Override	None
Intonation Map	1 Equal	Int Key	C
Pedal Noise	On	Drum Remap	None
Default Song	1 New Song		
SW1A Override	None		
SW2A Override	None		
SW1B Override	None		
SW2B Override	None		
CC1 Override	None		
CC2 Override	None		
Rotary Override	Button+Pedal		
◀ MORE	MAIN 1	MAIN 2	FX FILE MORE ▶

Velocity Map

The Velocity Map parameter determines the way the PC4 generates MIDI velocity information. Different maps generate different MIDI velocity values for the same physical key strike velocity .

The default map (Linear) provides the widest range of velocity expression, but you may want to choose a different map if the default does not suit your playing style. You can select from any of the following settings:

Light3 Light2 Light1	Makes it increasingly easier to produce high MIDI velocity values for the same key strike velocity (with Light3 being the easiest). These maps work best for those with a light touch.
Linear	The PC4 default map. Linear, allows MIDI velocities to pass unchanged. It follows a linear response.
Hard1 Hard2 Hard3	Makes it increasingly harder to produce high MIDI velocity values for the same key strike velocity (with Hard3 being the hardest). These maps work best for those with a heavy touch.
PianoTouch	Simulates the general velocity response of an acoustic piano, and is best suited for playing acoustic piano programs.
Easy Touch	Similar to the Light1/Light2/Light3 settings. Makes higher velocities easier to play, but allows more sensitive control over playing high velocities by not boosting the MIDI velocity for fast strike velocities as much as it does for medium strike velocities.
GM Receive	Mimics the velocity response commonly used by keyboards that use the General MIDI (GM) sound set. The GM Receive map makes medium strike velocities produce higher MIDI velocities compared to the Linear map.

Key Velocity Map

Adjust the velocity response per key. Select the “1 Flat” map and press the EDIT button to edit the map. In the Key Velocity Map editor, keys can be selected by scrolling, or using the Assign function of the Enter button (hold the Enter button and strike a key). Velocity response for each key can be adjusted by +/- 50. After making changes in the Key Velocity Map editor, press the SAVE soft button if you wish to save your changes as a user Key Velocity Map. Use the save dialog to select an ID to save to (32-127) and rename the map if desired.

Pressure Map

The Pressure Map parameter determines the way the PC4 controls Pressure (Aftertouch). Different maps generate different MIDI pressure values for the same physical key depending on how hard you press and hold the key.

Easiest Easier Easy	Makes it increasingly easier to produce high MIDI pressure values (with Easiest being the easiest).
Linear	The PC4 default map. Linear, allows MIDI pressure (aftertouch) to pass unchanged. It follows a linear response.
Hard Harder Hardest	Makes it increasingly harder to produce high MIDI pressure values (with Hardest requiring most pressure).

Press S Override

In addition to the Pressure Map parameter, Press S Override provides fine adjustment of key pressure (aftertouch) sensitivity. A setting of 0% prevents the generation of pressure messages.

Intonation Map

Most modern western music uses what is known as equal temperament. This means that the interval between each semitone of the 12 tone octave is precisely the same as every other semitone.

However, many different intonation intervals have evolved over the centuries and across cultures and instruments, so equal temperament will not sound appropriate for certain styles of music. The PC4 supplies you with 18 different factory intonation maps which are useful for a range of different styles. You can further customize each map or create your own by editing a map (see Editing Intonation Maps below.) Each of these maps defines different intervals between each of the semitones in a single octave (used for all octaves) by setting pitch offsets for each note in cents.

Like many instruments before the adaptation of equal temperament, most of these intonation maps were designed to sound best in one specific key. Though some may have historically been in a different key, all of the PC4's factory intonation maps are set to root note C by default. You can change the root key of the current intonation map by using the Int Key parameter (see the Intonation Key (Int Key) section below.)

0 None	No intonation map is used, intonation is equal.
1 Equal	No detuning of any intervals. The standard for modern western music.
2 Just	Tunings are defined based on the ratios of the frequencies between intervals. The original tuning of Classical European music.
3 Just/b7th	Similar to Just, but with the Dominant 7th flatted an additional 15 cents.
4 Harmonic	The perfect 4th, Tritone, and Dominant 7th are heavily flatted.
5 JustHarm	Approximation of a historical intonation.
6 Werkmeister	Named for its inventor, Andreas Werkmeister, it was developed to enable transposition with less dissonance than classic equal temperament.
7 1/5thComma	Approximation of a historical intonation based on the comma system.
8 1/4thComma	Approximation of a historical intonation based on the comma system.
9 IndianRaga	Based on the tunings for traditional Indian music.
10 Arabic	Oriented toward the tunings of Mid-Eastern music.
11 BaliJava1	Based on the pentatonic scale of Balinese and Javanese music.
12 BaliJava2	A variation on BaliJava1, slightly more subtle overall.
13 BaliJava3	A more extreme variation.
14 Tibetan	Based on the Chinese pentatonic scale.
15 Carlos A	Developed by Wendy Carlos, an innovator in microtonal tunings, this intonation map flats each interval increasingly, resulting in an octave with quarter-tone intervals.
16 Pyth/aug4	This is a Pythagorean tuning, based on the Greek pentatonic scale. The tritone is 12 cents sharp.
17 Pyth/dim5	This is a Pythagorean tuning, based on the Greek pentatonic scale. The tritone is 12 cents flat.
18 EastMed	Eastern Mediterranean. The Major 3rd and Major 7th are flat by 50 cents.

Editing Intonation Maps

To edit an intonation map or create a new map, select an existing map and press the EDIT button to view the intonation editor (see below). Intonation maps are based around a root key, use the CHANNEL/LAYER/ZONE/TRACK buttons to change the root key, and the layout of keys will shift in the display (this is the same as changing the Int Key parameter, see Intonation Key (Int Key) below). Intonation Key is not saved with the intonation map. Use the cursor to move between notes. Each note can be shifted by ± 200 cents (100 cents=1 half-step). Use the alpha wheel, or plus/minus buttons to enter the desired cent shift amount for each note.

Press the Save soft button to bring up the save dialog which allows you to rename the map and choose an ID to save to. Edited user intonation maps can be saved to IDs 32-127. Press the Exit soft button to return to the Global Main 2 page without saving your changes. When exiting the editor, it will automatically give you the option to save the map if changes have been made.



Int Key (Intonation Key)

This sets the tonic, or base note from which the currently selected intonation map calculates its intervals. If you select G as the intonation key, for example, and the intonation map you select tunes the minor 2nd down by 50 cents, then G# will be a quartertone flat relative to equal intonation. If you change the intonation key to D, then D# will be a quartertone flat. If you use nonstandard intonations, you'll want to set Int Key to the key you're playing in.

If the Intonation parameter is set to Equal, changing Int Key has no effect.

Drum Remap

This parameter will remap all Drum programs to conform to the General MIDI (GM) drum map, a standard drum map used in many keyboards and synthesizers.

When the Drum Remap is set to **None**, no remapping takes place in Program mode. When the Drum Remap is set to **GM**, the PC4 remaps Drum programs to the GM drum map.

Pedal Noise

Some piano Programs have a Pedal Noise feature programmed into the sound. This parameter allows you to turn the Pedal Noise off if you prefer not to use it. If it is on, it will only activate noise on those Programs that have been programmed to use it.

Default Song

The Default Song parameter determines which song will be used as a new song template when 0*New Song* is selected in Song mode. By selecting an edited user song, this allows you to set custom settings for the new song template (such as metronome Program and Count Off settings).

Switch Pedal Overrides

The Switch Pedal Override parameters (SW1A-SW2B Override) allow the controller assignments for the Switch Pedals to be changed for all Programs and Multis. (KB3 organ programs have a separate override for the SW1A pedal, see the Rotary Override section below for details.) The alternative assignments available for the Switch Pedal Overrides include the standard pedal controls of Sustain, Sostenuto and Soft as well as Data Inc, Data Dec, Quick Acc Inc and Quick Acc Dec, which can be used to change Programs, Multis or Quick Access spots by using a pedal.

Use the Data Inc and Data Dec assignments (data increment/decrement) to select the next or previous ID when you depress the pedal. If you are in Program mode, Data Inc and Data Dec will select the next or previous Program. If you are in Multi mode, Data Inc and Data Dec will select the next or previous Multi.

Use the Quick Acc Inc and Quick Acc Dec assignments (Quick Access increment/decrement) to select the next or previous Quick Access spot when you depress the pedal. If you do not have a Quick Access spot selected, Quick Acc Inc and Quick Acc Dec will select the first Quick Access spot, or the last spot that was selected since turning on the PC4.

Use the Arp On/Off and Arp Latch assignments to easily control arpeggiator functions. The Arp On/Off assignment allows you to toggle the arpeggiator on and off by pressing a switch pedal. The Arp Latch assignment allows you to latch held notes to be played by the arpeggiator by holding down a switch pedal. When using the Arp Latch assignment,

make sure the arpeggiator is turned on. Play the notes you wish to latch, press and hold the assigned pedal, then release the notes. The notes will continue to arpeggiate until the pedal is released. (The functionality may differ depending on the current arpeggiator Latch settings, see [Latch on page 3-24](#) for details.)

In Multi Edit Mode, if a pedal is selected which has a pedal override enabled in Global mode, a message “Global Pedal Override is enabled” will display when that pedal is viewed to remind you that the Global mode pedal override settings are being used instead of the Multi mode pedal settings.

In Multi Edit Mode, setting a Pedal Mode to “Off” will disable the override for that Pedal in the selected Zone. It can be useful in Multi Mode to disable the Pedal Override for some Zones. For example, you may want to use a Pedal Override to control Sustain in all Zones of a Multi, but disable Sustain for one Zone.

When a Pedal Switch Override is used, the pedal will behave in Multi Mode as if the OnValue and OffValue are set to 127 and 0 respectively (this will not be shown in Multi Edit Mode). When a Pedal Switch Override is set to Sustain, Sostenuto or Soft, the pedal will behave in Multi Mode as if Pedal Type is set to Momentary (this will not be shown in Multi Edit Mode). When set to Data Inc, Data Dec, Quick Acc Inc or Quick Acc Dec the pedal will behave in Multi Mode as if Pedal Type is set to Toggle (this will not be shown in Multi Edit Mode).

CC Pedal Overrides

In a similar manner to Switch Pedal Overrides, the CC Pedal Override parameters (CC1-2 Override) allow the Continuous Control Pedal assignments to be changed for all Programs and Multis. The alternative assignments available for the CC Pedal Overrides include Mod Wheel (MIDI CC 1), Foot/Wah (MIDI CC 4), Volume (MIDI CC7), Expression (MIDI CC11) and Pressure.

In Multi Edit Mode, if a pedal is selected which has a pedal override enabled in Global mode, a message “Global Pedal Override is enabled” will display when that pedal is viewed to remind you that the Global mode pedal override settings are being used instead of the Multi mode pedal settings.

Rotary Override

By default KB3 organ programs have the Slow/Fast speed control for the Rotary speaker effect assigned to the Variation Button and the Sustain Pedal (SW1A). The Rotary Override parameter allows you set the sustain pedal to function as sustain for all KB3 Programs, instead of Rotary Slow/Fast. The Variation button will always control the Rotary speed, regardless of this parameter's setting.

Global Mode

FX (Master FX Page)

FX (Master FX Page)

Press the FX soft button to view the Master FX page. The Master FX page contains master EQ and compressor settings. When the master EQ or compressor is enabled, all PC4 audio is processed by these effects.



When the Compressor is set to On, use the Comp Amount parameter to set the compression amount between 1 (least compressed) and 11 (most compressed).

FILE (Storage Page)

Press the FILE soft button to view the Storage page, which lets you use a USB device (such as a thumb drive) to load, store, back up, and copy files between the PC4 and the outside world. To use a USB device, plug it into the rear panel STORAGE port.

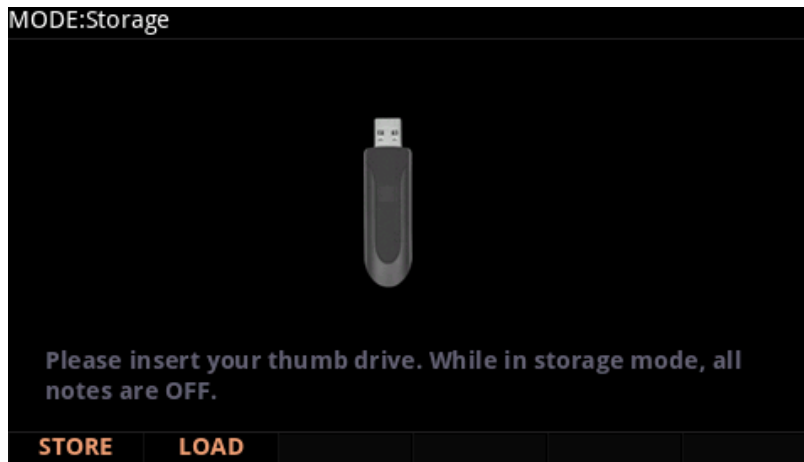

While using the Storage page, the playing of notes is disabled.

Storage Page Common Features

The following features are used in the Storage Page when saving or loading files:

Directories

A directory lets you group files together as you might separate documents using folders in a file cabinet. By default all storage devices have at least one “root” directory. To organize files in a USB device; you can create additional directories, as well as subdirectories within directories. Directories appear in the file list with the indicator <DIR> to the right of the directory name.

Path

When you choose the STORE or LOAD soft buttons on the Storage Page, you will have to choose exactly where in the storage device you wish to store to, or load from. This location is called a directory. When you need to choose a directory, you will see the Path field. The Path field shows the selected directory.

When you choose a storage function for a connected device, PC4 automatically chooses the root (top-level) directory for the Path field. The root directory is displayed as a backslash:

Path:\

Global Mode

FILE (Storage Page)

When viewing a page that has the Path field, if there are any directories available in the root directory you can select one using the alpha wheel, navigation buttons, or Previous/Next buttons. Press the OPEN soft button to open the selected directory. The name of the directory will be displayed in the Path field. For example, if you have a directory called SOUNDS that is located in the current device's root directory, the Path field will appear as:

Path:\SOUNDS\

The backslash character is a directory separator, as in the following Path:

Path: \BACKUP\COVERBAND\SONGS\

This represents the directory SONGS, which is a subdirectory of the COVERBAND directory, which is a subdirectory of the BACKUP directory in the root directory.

Use the OPEN soft button to navigate into directories and their subdirectories, away from the root directory. To navigate out of subdirectories back towards the root directory, use the PARENT soft button to move one level back from the current directory.

STORE

Press the STORE soft button when you have a storage device plugged into the PC4.

Store All

Press the ALL soft button to store all user objects into a single file, or press CANCEL to return to the previous page. After pressing STORE, you must select a directory and file name with the Select Directory dialogue, see below for details. The PC4 stores files using the file extension .PC4.

Store Advanced

Press the ADVANCED soft button to go to the Storage Advanced page where you can select one or multiple individual objects to store, instead of saving all user objects. The Storage Advanced page shows a list of all user objects grouped by type. Use the cursor up/down buttons to navigate through the list. The object that is currently highlighted can be selected or deselected for storing by pressing the SELECT soft button. An asterisk (*) appears between the ID and object type of selected objects.

Objects in the list are grouped by object type. Pressing the TYPE soft button will jump to the next different type of object in the list.

After selecting objects to store, press the STORE soft button to store the selected objects, or press CANCEL to return to the previous page. After pressing STORE, you must select a directory and file name with the Select Directory dialogue, see below for details. The PC4 stores files using the file extension .PC4.

The Select Directory Dialogue

When storing, the PC4 will prompt you to select a directory in which to store.

There are three navigating soft buttons on the left side of the bottom of the page:

NEWDIR	Create new directory. Calls up the New Directory dialogue (see the following section)
OPEN	Opens the highlighted directory
PARENT	Moves you up one level in the directory hierarchy. If the display is already at the root directory, this button has no effect.

When you have chosen your directory, press the OK soft button to go to the File Name dialogue and complete the storing process (see below).

The File Name / New Directory Dialogue

When you store a file or create a new directory using the Storage Page, the PC4 prompts you to enter a name with the File Name or New Directory dialogue. Edit the name using the keypad, alpha wheel, Previous/Next buttons, Left and Right navigation buttons, and soft buttons. Press the OK soft button to finish the operation.

LOAD

Use the LOAD page to load compatible files from a storage device.

To view the load page, plug a USB storage device into the PC4 and press the LOAD soft button.

Use the navigation buttons, Previous/Next buttons or the Alpha Wheel to browse the files in the storage device.

After selecting a file to load, press the OPEN, FILL or OVWRITE soft button to continue

OPEN	Pressing the Open soft button will open the highlighted folder or object file.
PARENT	Selecting Parent will close an existing open folder.
FILL	Selecting FILL means you would like to keep the existing User objects. PC4 will now load the User objects into the first empty ID slot it finds, and then subsequent empty slots.
OVERWRITE (OVWRITE)	Selecting OVWRITE first deletes all the existing User objects, and then loads the new User objects using the object ID numbers stored in the file. OVWRITE appears only when a .PC4 file is selected.

Fill

Pressing the Storage Page Load FILL soft button will show the “Fill from ID” dialog. When you select a saved object file to load, “Fill from ID” allows you to choose the ID number at which you would like to begin loading objects. This allows you to load user objects to specific IDs, instead of always loading from the unused IDs starting at ID 4096. This can be useful for organizing user objects in specific ID ranges.

Overwrite and Merge

When the OVWRITE soft button is pressed, you are given the option to load objects using the Overwrite or Merge method. Selecting Overwrite first deletes all the existing user objects, and then loads the new user objects using the object ID numbers stored in the file. Selecting Merge will load the new user objects using the object ID numbers stored in the file, only deleting existing objects which use the same ID numbers. Existing user objects that use other IDs will not be deleted.

Loading .WAV and .AIF Audio Files

From the LOAD page, .WAV and .AIF audio files can be loaded and used with user created keymaps (see [“Building a Keymap” on page 5-8](#) and [“Editing Samples” on page 5-10](#).) Mono and stereo files can be loaded, 8 or 16 bit, with sample rates up to a maximum of 96000 Hz. Once samples are loaded to the PC4’s user sample flash memory, samples remain in the PC4 even when the power is off, until they are manually deleted. Also, once samples are loaded to the PC4’s user sample flash memory, there is no load time for those user samples when turning on the PC4.

To load a user audio file, select a .WAV or .AIF file from the LOAD page file list and press the FILL soft button. On the “Fill from ID” page, select an ID then press the FILL soft button again to begin loading samples into unused user IDs.

On the Keymap Editor Main page (see [“The Keymap Editor” on page 5-1](#)) loaded audio samples can be selected in the Sample field. In the Sample field, you can find the audio file you loaded by entering 4096 (or whichever ID you filled from) on the alphanumeric keypad and pressing Enter. If you have previously loaded user samples, you may have to scroll above 4096 (or whichever ID you filled from) as your sample will have been loaded into the next available unused ID.

Loading Individual Objects From a .PC4 or Compatible File Type

Since a .PC4 file can contain thousands of objects, it is often useful to load only some of the objects contained in a file. You can select individual objects or groups of objects (Programs, Multis, etc) for loading from within a single .PC4, .SP6, .FSE, .FOR, .ASE, .ART, .P3A, .PC3, .P3K, .PLE, or .SPX file.

To load individual objects, use the LOAD page to highlight a compatible file type, then press the **OPEN** soft button to view a list of objects within the file. The objects in the list are grouped by type (Programs, Multis, etc.). Scroll through the list using the alpha wheel, cursor buttons, or Previous/Next buttons. Each line in the list represents one object, and displays the object's number in the list, as well as the object's type, original ID number, and name.

Press the **SELECT** soft button to select or deselect the highlighted object for loading. Multiple objects can be selected. An asterisk (*) is placed to the left of selected objects.

Press the **FILL** soft button to load the selected objects, or press the **CANCEL** soft button to return to the file list dialog.

Compatible Files

The PC4 can load its own .PC4 files, as well as file types from other Kurzweil products such as .SP6, .FSE, .FOR, .ASE, .ART, .P3A, .PC3, .P3K, .PLE, .SPX, and .SYX files. When loading file types other than .PC4, the PC4 will attempt a conversion of the objects in those files. The PC4 can often exactly match the sound and function of the original objects. In some cases object parameters may not be converted and must be adjusted by the user after conversion (see below for details).

Importing Program Objects

When importing a Program object from a .P3A, .P3K, .PC3, .PLE, or .SPX file, Parameter info names and some controller assignments may need to be manually adjusted.

Importing Forte (.FOR) Objects

Some Forte Programs (stored in .FOR files) may not be compatible if they use keymaps and samples that are not available on the PC4. It may be possible to import and edit these Programs on the PC4 and select PC4 keymaps that sound very similar to the incompatible Forte keymaps. For example, the PC4 does not have the same Japanese Grand Piano keymaps and samples that the Forte has, but it does have similar keymaps that use a reduced set of the Forte Japanese Grand Piano samples.

Importing FM (.SYX) Programs

The PC4 can load .SYX files containing FM programs from classic 6 operator FM synthesizers. Imported FM programs can be edited in Program Mode and combined with additional layers and VAST synthesis features. For details on editing imported FM programs, see [“Editing FM Layers” on page 3-82](#).

Global Mode

FILE (Storage Page)

Example Using LOAD

The following example shows how each loading method affects how programs are loaded into the User bank when it already contains programs.

Example: Starting with the following objects already stored in the PC4 User bank:

Programs currently in PC4	
Program ID	Program Name
4096	3rd World Order
4097	PC3 Strings
4100	JuPiTaR BazZ
4103	VA1 Lead

Suppose you were to load a .PC4 file containing the following Programs:

File to be Loaded	
Program ID	Program Name
4097	Synth Horn
4098	NYJazzy
4099	Saxxy
4100	Stabbatha

The two tables below show the results if you use FILL from 4096 or OVWRITE with the User Bank.

PC4 after using FILL	
Program ID	Program Name
4096	3rd World Order
4097	PC3 Strings
4098	Synth Horn
4099	NYJazzy
4100	JuPiTaR BazZ
4101	Saxxy
4102	Stabbatha
4103	VA1 Lead

PC4 after using OVWRITE	
Program ID	Program Name
4096	
4097	Synth Horn
4098	NYJazzy
4099	Saxxy
4100	Stabbatha
4101	
4102	
4103	

MIDI Page

The PC4 can transmit and receive MIDI via its MIDI ports and USB. The MIDI page in Global Mode allows you to configure how this will be handled.



Destination

The Destination parameter determines the destination of MIDI data generated by striking keys or activating controllers. This data can be sent to the PC4 sound engine, through the MIDI out ports, or both. You can set this parameter to NONE, or any combination of the three available destinations.

Note that this parameter is always active and works in conjunction with the Multi Mode Destination parameter (see [Destination on page 7-6](#)). These parameters act like filters, so if the Multi Mode Destination parameter is set to USB+MIDI+LOCAL and the Global Mode parameter is set to LOCAL, the MIDI data will only be transmitted locally.

If you want to play the PC4, but not send any MIDI information to other MIDI instruments, then select LOCAL.

If you want to use the PC4 strictly as a MIDI controller for the other modules in your MIDI chain using the MIDI port, then select MIDI.

If you want to make use of the PC4's sounds as well as use it as a MIDI controller (MIDI port), then select MIDI+LOCAL.

If you want to use the PC4 strictly as a MIDI controller for the other modules in your MIDI chain using the USB (Computer) port, then select USB.

If you want to use the PC4 strictly as a MIDI controller for the other modules in your MIDI chain using the MIDI port and the USB (Computer) port, then select USB+MIDI.

If you want make use of the PC4's sounds and use it as a MIDI controller for the other modules in your MIDI chain using the MIDI port and the USB (Computer) port, then select USB+MIDI+LOCAL.

Change Multis

The Change Multis parameter determines the exact timing of Multi changes when you select a different Multi, either by a normal data entry method or via MIDI program change commands.

Choose AllKeysUp to indicate that you want Multi changes to take place only when you've released all currently held notes.

Choose Immediate to indicate that you want such changes to happen immediately when you select the Multi.

Bank Select

The Bank Select parameter determines the controller number with which MIDI Bank change messages are received.

For MIDI Bank change messages, various manufacturers have chosen different MIDI controller numbers. Most have chosen Ctl 0, Ctl 32, or both. You can set this parameter to any of the following three settings:

Ctl 0	MIDI Bank change messages are received with controller number 0.
Ctl 32	MIDI Bank change messages are received with controller number 32.
Ctl 0 / 32	MIDI Bank change messages are received with both controller numbers 0 and 32.

PrgChangeMode

The Program Change Mode (PrgChangeMode) parameter determines the format of program change messages received by the PC4.

Program Change Type	For Use With
Extended	Bank changes and Program changes. A bank has 128 IDs. Note that our system will recognize 16 banks, from 0 to 15. (2048 IDs). This is for connecting a generic MIDI device as a controller device.
K2600	Bank changes and Program changes. A bank has 100 IDs. Our system will recognize in this case 21 banks, from 0 to 20. For example, with MIDI out from a K2600 into the MIDI in of the PC4, if you scroll or enter a number in the K2600, you will see the same numbers in the K2600 and in the PC4 if the programs exist.
Quick Access	For use with other PC4's.

Local Kbd Chan (Local Keyboard Channel)

The Local Keyboard Channel enables an external MIDI keyboard to function as if it is the PC4's keyboard and physical controllers. This allows all Channels/Zones of a Multi to be played simultaneously from an external MIDI keyboard transmitting on a single MIDI channel (or a single MIDI channel of a sequencer), with split and layered Zones laid out across the external MIDI keyboard. To do this, set Local Kbd Chan to the same MIDI channel that your external MIDI keyboard or sequencer is transmitting.

If you are not using an external MIDI device to play Multis, you can ignore this parameter and leave it set to None. When Local Keyboard Channel is set to None, an external MIDI device transmitting on one channel will only play one Channel/Zone of a Multi.

In Program Mode, an external MIDI keyboard or sequencer transmitting on the Local Kbd Chan will always play the Program on the currently selected Program Mode MIDI channel.

Sysex ID

The SysEx ID parameter determines the ID number for the unit if you are using more than one device with the same MIDI manufacturer ID number. You can set this parameter to any number from 0 to 127.

Unless you have multiple PC4 keyboards receiving Sysex messages from a single source, you will not need to change the Sysex ID from the default setting of 0.

If you do have multiple PC4s receiving Sysex messages from a single source, make sure each PC4 has a different Sysex ID. This will allow you to direct Sysex messages to the appropriate PC4 by specifying which unit with the Sysex ID byte that's included with every Sysex message.

To have the unit respond to Sysex messages regardless of the Sysex ID, set Sysex ID to 127.

Program Change

Use the Program Change parameter to enable or disable sending program change messages to external MIDI devices when selecting Programs in Program Mode, Multi Edit Mode, or when selecting a Multi in Multi Mode.

Clock Source

With the Clock Source parameter set to Internal, PC4 plays using its own Tempo. If you wish to sync the PC4 to the tempo of an external device, use the External setting.

Output Clock

To send a MIDI clock pulse to the USB and MIDI Out ports, set this parameter to On. Otherwise, set it to Off.

Receive MMC (Receive MIDI Machine Control)

Use the Receive MMC parameter to enable or disable receiving of MIDI Machine Control messages sent to the PC4's MIDI In or USB ports. When Receive MMC is set to Off, the PC4 will ignore MMC messages. When Receive MMC is set to On, the PC4's Song Mode will respond to MMC messages for Song Play and Song Stop. This allows you to use an external sequencer to start or stop the currently selected song in PC4's Song Mode, as well as set the bar/beat location of the current song.

OBJECTS Page

Use the Global Object Utils page to move or delete User objects. Press the EXIT button to leave the page.



Caution: Deleted User objects can not be restored. All User objects that you wish to save should be saved to an external USB device before deleting, see [STORE on page 9-18](#) for details.



Use the navigation buttons to highlight the object that you wish to move or delete, then press the **SELECT** soft button to select the object. Selected objects are marked with an asterisk, and multiple objects can be selected at the same time.

Objects in the list are grouped by object type. Press the **TYPE** soft button to jump to the next different type of object in the list.

Press the **MOVE** soft button to move the selected objects to a different ID.

Press the **DELETE** soft button to delete the selected objects.

Press the **OPTIONS** soft button to view the Options page. The Options page allows you select objects by ID range and type, as well as adding dependent objects to the currently selected objects. On the Options page, press the **SET** soft button to select objects based on the current settings.

QA Banks

Press the **QA BANKS** soft button to view the QA Bank Edit page. The QA Bank Edit page allows you rename, move or delete user edited QA Banks.

SAMPLES

To move or rename a single QA Bank, use the PREVIOUS/NEXT buttons or ALPHA WHEEL to highlight a QA Bank in the list, then press the SAVE button to the left of the display to view the Save dialog, which allows you to Save the bank to a different ID or rename it.

To move or delete one or more QA Banks, use the PREVIOUS/NEXT buttons or ALPHA WHEEL to highlight a QA Bank, then press the SELECT soft button to select each QA Bank. Selected QA Banks are marked with an asterisk, and multiple QA Banks can be selected at the same time. Press the **MOVE** soft button to move the selected QA Banks to a different ID. Press the **DELETE** soft button to delete the selected QA Banks.

SAMPLES

Press the SAMPLES soft button to view the User Sample Memory page. This page is useful for seeing how much user sample memory is available for loading WAVE/AIFF audio files and user samples into the PC4's flash memory.

The **Total available** field allows you to monitor how much user sample space is available (out of 2000 MB). The **Largest free chunk** field shows you how much contiguous user sample space is available. This represents the size of the largest single sample that can be loaded.

When some user sample memory has been used, it is represented on this page by solid white squares. If you have loaded and deleted many samples, the page will likely show many groups of white squares with empty spaces in between (known as fragmented memory).

Large user samples must be loaded into adjacent blocks of memory. If the memory has become fragmented, you may be unable to load a large sample, even if there appears to be enough available memory. For example, if the memory is fragmented and the Total Available field shows 100 MB, you may not be able to load a 50 MB audio file (but you may be able to load ten 10 MB audio files).

To clean up the user sample memory when it has become fragmented, you can back up all user objects and samples to a USB device, delete all user objects and samples by performing a hard reset, then reload the saved user objects and samples. For details see [Store All on page 9-18](#), [Hard Reset on page 9-33](#), and [LOAD on page 9-19](#).

PREVIEW (Sample Preview)

Press the PREVIEW button to go to the Sample Preview page. The Sample Preview page can be used to automatically make a new keymap and Program using any sample or group of sample roots (factory or user samples). Programs created with the preview function are saved in Program Mode. This allows you to quickly hear what a sample or group of sample roots will sound like in a Program. The preview function is also a quick way to begin making a new Program which can be edited further if desired.

If a single sample is selected, a single keyrange keymap will be created. If a group of sample roots is selected, the preview function will try to create a keymap with multiple key ranges based on each sample's root key. If the sample or group of sample roots are stereo, the created keymap will be stereo.

To use the preview function, go to the PREVIEW page, select a sample or group of sample roots in the Sample field using the Alpha Wheel, +/- buttons, or the alphanumeric pad, then press the OK soft button. Next you will be brought to the "Fill from Id" page, where you must select an ID to store the new keymap and program. The preview function will save the created program and keymap using the selected ID, or the next higher numbered unused ID. The preview function will never overwrite existing Programs or keymaps. Press the OK soft button to choose the selected bank and create the new Program and keymap. The new program will be selected in the currently selected channel in Program Mode.

MIXER



The Mixer page allows you to view and control the current state of the PC4's 16 MIDI channels. The currently selected Channel and Program are displayed in the top line. Press the **1-8** or **9-16** soft button to view channels 1-8 or 9-16.

Press the **AUTO** soft button to enable or disable automatic channel selection. When the **AUTO** soft button is black (disabled), the keyboard will play the channel selected with the **CHANNEL/LAYER/ZONE/TRACK** buttons. When the **AUTO** soft button is red (enabled), the keyboard will play the channel of the currently selected parameter.

Use the **Enable** parameter to enable or disable the Program on each MIDI channel.

The **Prog** parameter allows you to view and change the Program number of each Channel.

The **Pan** and **Vol** parameters allow you to view and adjust the left right panning (MIDI CC 10) and channel volume (MIDI CC 7) of each Channel. You can also use sliders 1-8 to adjust the channel volume of the 8 currently displayed channels.

Global Mode

TEMPO

The **lock** symbol next to each Prog, Pan and Vol parameter allows you to lock the current Program, Pan and Volume setting for each channel so that it can not be accidentally changed by external MIDI messages sent to the PC4 when using external MIDI equipment. When the lock symbol is green, the value is unlocked and can be changed normally. When the lock symbol is red, the value is locked. Select the lock symbol and press the Previous or Next button to unlock or lock each parameter.

Press the **BACK** soft button to return to Global Mode.

TEMPO

Press the TEMPO soft button to go to the TEMPO page. When the Clock Source parameter is set to Internal (see [Clock Source on page 9-26](#)), the Tempo parameter sets the PC4's System Tempo. The Tempo parameter values are in units of BPM (beats per minute).



Set the Tempo parameter with the Previous/Next buttons, the Alpha Wheel, or alphanumeric entry. You can also set the system tempo by using the TEMPO section of the front panel. Press the TAP button a few times at the desired rate, or use the TEMPO knob.

In Program Mode, System Tempo can control the rate of each Program's arpeggiator, as well as the rate of any tempo synced LFOs or Insert or Aux effects that each program may use. Most programs will default to using the System Tempo, though some programs may be programmed use their own tempo (for details see [Tempo on page 3-24](#)). All programs can be set to use the System Tempo by setting the Global Mode Program Tempo parameter to "System". For details see [Program Tempo on page 9-6](#).

In Multi Mode, System Tempo is ignored and the Multi Common Tempo of each Multi is used for all programs in a Multi.

INFO

The INFO page contains the system information indicating what version of operating system and objects is currently installed.

Go to the Kurzweil website at www.kurzweil.com and make sure that you have the latest operating system available.

TOOLS Page

Pressing the TOOLS soft button calls up a page that gives you access to several analytic and diagnostic tools. Additionally, pressing the two center soft buttons simultaneously will call up the TOOLS page from any mode. Press the EXIT button when finished.

MIDI OUT and MIDI IN

Press the MIDI OUT or MIDI IN soft buttons to view the MIDI Scope page for the MIDI Out or In ports, where you can monitor MIDI messages in real time. The MIDI OUT Scope page allows you to view MIDI messages sent from the PC4, while the MIDI IN Scope page allows you to view MIDI messages received by the PC4. The MIDI OUT Scope page is useful for making sure controls are assigned as you want them, checking note velocities, and checking controller values or other MIDI messages. The MIDI IN Scope page is useful for checking MIDI messages sent to the PC4 from external MIDI devices. Each MIDI Scope page can store a history of 512 messages. Use the cursor Up and Down buttons to scroll up through the list of messages. The most recently sent or received message will be labeled number 1 at the bottom of the list.

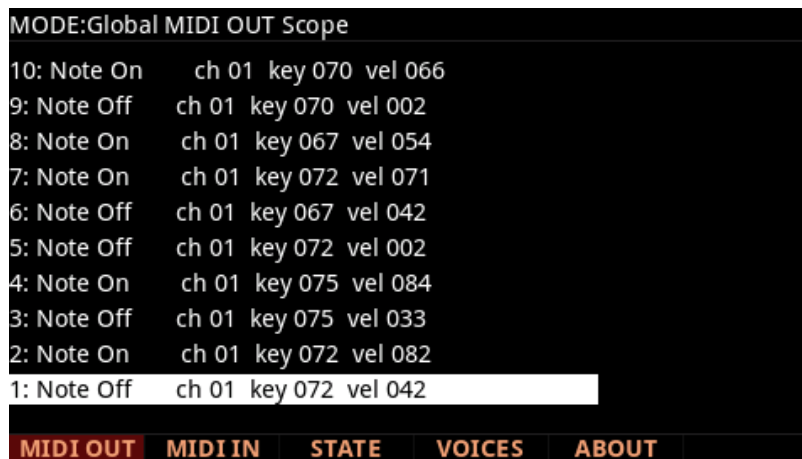

```
MODE:Global MIDI OUT Scope
10: Note On   ch 01 key 070 vel 066
9: Note Off  ch 01 key 070 vel 002
8: Note On   ch 01 key 067 vel 054
7: Note On   ch 01 key 072 vel 071
6: Note Off  ch 01 key 067 vel 042
5: Note Off  ch 01 key 072 vel 002
4: Note On   ch 01 key 075 vel 084
3: Note Off  ch 01 key 075 vel 033
2: Note On   ch 01 key 072 vel 082
1: Note Off  ch 01 key 072 vel 042
```

MIDI OUT MIDI IN STATE VOICES ABOUT

STATE

The MIDI State page shows the state of the MIDI CCs in each PC4 MIDI channel.

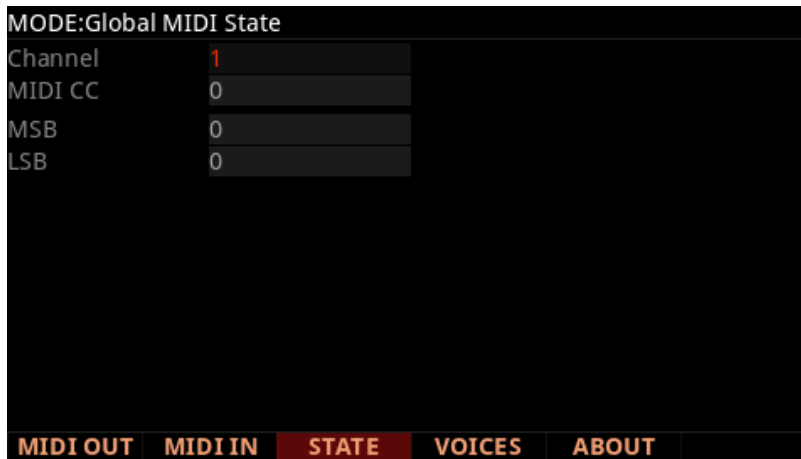

For example, if a channel is not making any sound, you can check the values for MIDI CC 7 (Volume) and MIDI CC 11 (Expression). Use the cursor buttons to select the Channel or MIDI CC fields, then use the alpha wheel or previous/next buttons to select the desired Channel and MIDI CC to view.

VOICES

Pressing the Voices soft button calls up the Voice Status page, which shows the PC4's active voice channels as you play.

The Voice Status pages displays each active voice as an "M" for mono voices or displays stereo pairs of voices as an "S". Whatever symbol the page displays, when the key of a voice is released, that voice's symbol on the Voices Status page turns into a "D" during the release portion of that voice's envelope. When the voice decays to silence, it is no longer active, and the "D" disappears.

The Voice Status page gives you an indication of the current envelope segment of each voice. This can give you a valuable indication of how your voices are being used. For example, if all or most of the voices are active due to long release segments, then there's a good chance that when voice stealing takes place an audible voice will be reallocated.

Only one KB3 Program can be active on the PC4's 16 MIDI channels at any time. The bottom of the voices page indicates which of the PC4's 16 MIDI channels (if any) has an active KB3 program.

ABOUT

The ABOUT Page displays the PC4 splash screen and automatically scrolls a list of credits and acknowledgments.

RESET Page

Press the RESET soft button to view the Global Reset page, where you can choose to perform a Soft Reset or Hard Reset.

Soft Reset

A Soft Reset restores all Global mode settings to their factory defaults. User objects are not deleted. Press the SOFT soft button to perform a soft reset.

When the soft reset is completed, the PC4 will enter System Mode. In System Mode, press the RUN PC4 soft button to return to Program Mode.

Hard Reset

A Hard Reset restores all Global mode settings to their factory defaults, and deletes all User objects. Press the HARD soft button to perform a hard reset.

When the hard reset is completed, the PC4 will enter System Mode. In System Mode, press the RUN PC4 soft button to return to Program Mode.



Caution: Hard Reset will delete all User objects. All User objects that you wish to save should be saved to an external USB device before doing a Hard Reset, see [STORE on page 9-18](#) for details. Factory objects are not deleted.

Chapter 10

Troubleshooting

Maintenance

Aside from normal care in handling and use, your PC4 requires no regular maintenance. Clean with a soft dry cloth. Never use abrasives or solvents as they may damage the unit's paint, markings, and display screen. There are no batteries inside to replace. Instead of volatile SRAM used in most other instruments, your PC4 uses nonvolatile Flash Memory for storage, which retains information without power.

Common Problems

Below is a list of the most commonly encountered problems and diagnoses for each.

Power Problems

This is the normal power-up sequence:

1. The display backlight turns on.
2. "Loading..." appears on the display for a few seconds.
3. The PC4 enters Program Mode with Program 1 selected, or the Program that was selected the last time Global mode was exited.

If nothing at all happens when you turn the power switch on, check if one of the following might be the issue:

ISSUE	The power cable is not plugged securely into the wall outlet.
REMEDY	Plug the power cable securely into the wall outlet.

Troubleshooting

Common Problems

ISSUE	The power cable is not plugged securely into the PC4 power jack.
REMEDY	Plug the power cable securely into the PC4 power jack.

ISSUE	The wall outlet, power strip, or extension cord is defective or damaged.
REMEDY	Use a different wall outlet, power strip, or extension cord.

If there's evidence of the unit receiving power, but operation is abnormal, check if one of the following might be the issue:

ISSUE	The wall outlet voltage is below 90 volts due to overload.
REMEDY	Try a different outlet on a different circuit.

Display “Brightness”

ISSUE	The Display is blank or difficult to read.
REMEDY	Slowly turn the Display brightness knob (located above the Navigation buttons) to adjust the Display.

Audio Problems



Caution: Do not troubleshoot audio problems using headphones. Always be aware of the volume levels on the PC4 and on the connected audio system or mixer.



Note: When diagnosing audio problems, set the PC4 to play a Song Demo rather than intermittently pressing keys. This will prevent any unexpectedly loud volume changes.

If there is no sound from your PC4, check if one of the following might be the issue:

ISSUE	The volume Slider is turned down.
REMEDY	Slowly push the volume slider up.

ISSUE	The volume control on the audio system or mixer is turned down.
REMEDY	Slowly turn the volume control up.

ISSUE	The signal source selection on the audio system or mixer is incorrect.
REMEDY	Set the volume of the audio or mixer to the lowest level, select the correct signal source, and then slowly turn up the volume.

ISSUE	The audio cables are not securely plugged into the PC4, audio system, or mixer.
REMEDY	Set the volume of the audio or mixer to the lowest level, securely plug in the audio cables on both ends, and then slowly turn up the volume.

ISSUE	The Destination parameter stops MIDI Data.
REMEDY	Change the Global Mode (MIDI page) “Destination” parameter to USB+MIDI+LOCAL (see page 9-23)

ISSUE	The audio cable is of an incorrect type.
REMEDY	Obtain and securely connect an audio cable of the correct type. The PC4 accepts both balanced (TRS) and unbalanced (TS) 1/4-inch audio cables.

Troubleshooting

Common Problems

If you can hear sound but it is low or distorted, check if one of the following might be the issue:

ISSUE	A received MIDI volume message has specified a low volume.
REMEDY	Set the volume of the audio system or mixer to the lowest level. Disconnect all MIDI cables, set the “Destination” parameter in Global Mode (MIDI page) to LOCAL or USB+MIDI+LOCAL and reset the volume level on the PC4, by pressing Panic (see Panic on page 1-16). Finally, slowly turn up the volume level of the audio system or mixer.

ISSUE	The current Multi has another controller assigned to volume, and it is turned down.
REMEDY	Select a different Multi. Or change the problematic controller setting by editing the Multi in Multi Edit Mode.

ISSUE	The audio system input is set for low impedance instead of high impedance.
REMEDY	Set the volume of the audio system or mixer to the lowest level, change the impedance setting, and then slowly turn up the volume of the audio system or mixer.

ISSUE	The input trim to the audio system or mixer is set too low.
REMEDY	Slowly turn up the trim.

MIDI Problems

If you are experiencing problems sending MIDI to an external module, check if one of the following might be the issue:

ISSUE	The MIDI cable is not securely plugged in at both ends.
REMEDY	Securely plug in the MIDI cable at both ends.

ISSUE	The MIDI connections are wrong.
REMEDY	To send MIDI, plug the MIDI cable into the PC4's MIDI Out port and into the module's MIDI In port.

ISSUE	The MIDI cable is defective.
REMEDY	Obtain and securely connect a new MIDI cable.

ISSUE	The MIDI transmit channel does not match that of the receiving device.
REMEDY	Change the channel on either the PC4 or on the device such that the channels match.

If there are problems with the internal sound module receiving MIDI from an external device like a computer sequencer, check if one of the following might be the issue:

ISSUE	The MIDI transmit channel of the transmitting device does not match that of the receiving Program or Zone on the PC4.
REMEDY	Change the channel on either the PC4 or on the computer such that the channels match.

ISSUE	The MIDI cable is not securely plugged in at both ends.
REMEDY	Securely plug in the MIDI cable at both ends.

ISSUE	The MIDI connections are wrong.
REMEDY	To receive MIDI, plug the MIDI cable into the PC4's MIDI In port and into the module's MIDI Out port.

Pedal Problems

Before you consult this section, be sure to read [SW1 \(SUSTAIN\) and SW2 Jacks on page 1-9](#).

Switch Pedal Problems

If you are having problems with connecting or using a switch pedal, check if one of the following might be the issue:

- Sustain or Sostenuto is stuck “on.” Be sure the pedal is plugged in before switching on the power. Turn power off, then on, if necessary.
- The pedal is acting backwards (“on” when up instead of down). Power cycle the unit making sure to NOT press on the pedal during startup.

Other Problems

If your problem is not covered in this chapter, or if none of the suggestions seem to work, be sure to check Kurzweil’s website for additional PC4 information that may have been published since this manual was written: www.kurzweil.com.

If you still have problems, contact Kurzweil support in your country or at www.kurzweil.com/support/. You may also find unofficial help at some of the internet communities listed at www.kurzweil.com/community/.

Service Centers

To contact the nearest Kurzweil service representative, see [Kurzweil International Contacts on page iv](#) in the front of this manual for contact information.

Restoring Factory Defaults

For restoring your PC4 back to the factory defaults, see [RESET Page on page 9-33](#)

Appendix A

MIDI Implementation

Function		Transmitted	Recognized	Remarks
Basic Channel	Default	1	1	Memorized
	Changed	1–16	1–16	
Mode	Default	Mode 3	Mode 3	Use Multi-track mode (see the FX Mode parameter in Global Mode for multi-timbral applications)
	Messages			
	Altered			
Note Number			0–127	
	True Voice	0–127	0–127	
Velocity	Note ON	O	O	
	Note OFF	O	O	
Aftertouch	Keys	X	O	
	Channels	O	O	
Pitch Bender		O	O	
Control Change		O 0–31 32–63 (LSB) 64–127	O 0–31 32–63 (LSB) 64–127	Controller assignments are programmable
Program Change		0 to 2,097,151	0–511	Standard and custom formats
	True #	0–127	0–127	
System Exclusive		O	O	
System Common	Song Pos.	X	X	
	Song Sel.	X	X	
	Tune	X	X	
System Real Time	Clock	O	O	
	Messages	O	O	
Aux Messages	Local Control	O	O	
	All Notes Off	O	O	
	Active Sense	X	X	
	Reset	X	X	
Notes		Manufacturer's ID = 07 Device ID: default = 0; programmable 0–127		
Mode 1: Omni On, Poly Mode 3: Omni Off, Poly		Mode 2: Omni On, Mono Mode 4: Omni Off, Mono		O = Yes X = No

Appendix B

Specifications¹

Keyboard:	PC4: RPHA: Real Piano Hammer Action with After Touch. 88-key, fully-weighted hammer-action with velocity and pressure (After Touch) sensitive adjustable keys PC4-7: SWA76: Semi-Weighted Action with After Touch. 76-key, semi-weighted action with velocity and pressure (After Touch) sensitive adjustable keys
Display:	480 x 272 pixel high resolution color LCD with adjustable brightness
Polyphony:	256 Voice Polyphony, dynamically allocated
Multitimbral:	16 parts (one per MIDI channel)
Quick Split / Layer:	Easy access with adjustable volume and panning
Programs:	Over 1000 Factory Programs plus 4000 User Program IDs.
Multis:	Over 50 Factory Multis, 4000 User Multi IDs, 16 programmable zones for splits and layers
Effects:	Hundreds of complex effect chains, user editable
Controllers:	<ul style="list-style-type: none"> • Pitch wheel • Modulation wheel • Volume slider • 9 front panel sliders • 9 knobs • 9 switch buttons (assignable / zone mutes / KB3 control) • Variation button • Tempo Section (Tempo Knobs and Tap Tempo button) • Transport Section (Stop, Play/Pause, Record, Locate) • Arpeggiator On/Off button • 2 switch pedal inputs, each supporting single switch pedal or single half damper pedal • 2 continuous control pedal inputs • 2 Transpose buttons • Ribbon Input
Analog Outputs:	Four 1/4" TRS Balanced Outputs (Two Stereo Pairs, A & B) 1/4" Stereo Headphone Output 32-bit D-to-A Converters
Analog Inputs:	Two 1/4" Line Inputs (One Stereo Pair) One 1/8" Stereo Line Input
MIDI:	IN, OUT
USB:	Complete MIDI functionality over USB User Object file transfer to/from USB Flash Drive Operating System updates from USB Flash Drive
Height:	PC4: 6.5" (16.51 cm) PC4-7: 4.24" (10.78 cm)
Depth:	PC4: 14.75" (37.46 cm) PC4-7: 14.07" (35.75 cm)
Length:	PC4: 51.25" (130.175 cm) PC4-7: 46.54" (118.2 cm)
Weight:	PC4: 28.7 lb (13.01 kg) PC4-7: 19.4 lb (8.8 kg)
Power:	External Power Supply, 15VDC 2.5A

¹ Specifications subject to change without notice

Appendix C

Programs

Object Version 1.00.24

PIANO		25	Upright Piano	48	Broken EP
1	Dyn 9ft Grand	26	Pub Piano	49	Bright EP
2	Bright Jazz 9ft	27	Mono Upright	50	Phase EP
3	Smooth Grand 9ft	28	Mono Piano	51	Mtron EP
4	RecitalGrand 9ft	29	R&B Stack	52	Warble Rd. EP
5	Recital Piano	30	Bright PnoPad7ft	53	EP Reed
6	Concert Piano	31	Piano & Strings	54	WoodstockClunker
7	Fierce Rock 9ft	32	Glam Rock Pno9ft	55	SlyBallad EP
8	Punchy Edge	33	Dark & Distant	56	ACL EP Reed
9	Seventies Piano	34	Indie Piano	57	Daft Reed EP
10	Blues Piano	35	SMiLE/RkyRaccoon	58	These Eyes
11	New Orleans	36	EDM Piano	59	MistyMountain EP
12	Modern Rock Pno	37	Hip Hop Piano	60	She'sNotThere
13	Stadium Pop Pno	38	ArakisPno^DrkPno	61	Black Friday
14	Rich Grand 7ft	39	Film Piano	62	Walrus Keys
15	Studio Grand 7ft	40	Alt Piano Space	63	No Quarter Pnt
16	Solo Grand 7ft	41	Alt Piano Echo	64	Flaming EM EP
17	Intimate Pno 7ft	42	Dream Piano	65	PowerChordKeys
18	Stereo Pno K26			66	E-cousticGrand
19	Concert Pno K26	E.PIANO		67	CP80 Enhanced
20	Horowitz Grand	43	Suitcase EP	68	VidKilledRadio
21	Rubenstein Comp	44	EZ Tube EP	69	UK Pop CP70
22	Deb's Ghost Pno	45	Tube Amp EP	70	PG's Melt
23	VintageGrand 7ft	46	Tube & Trem EP	71	Inside Out CP
24	Olde Pub Piano	47	Dyno EP	72	Royal EP

170	BrgtTubeScream	207	Pipes & Voices	244	2 2/3' Gamba
171	Sly's Revenge	208	AllStps AllVox	245	2 2/3'DiaCeleste
172	Real Out	209	16' Open Flute	246	2 2/3' Ballpark
173	Tube Dist B3	210	16' Stop Flute	247	2 2/3' Viol
174	Ready to Rock	211	16' Diapason	248	2' Open Flute
175	Thick Gospel	212	16' Ped Bourdon	249	2' Stop Flute
176	PicturOfNectar	213	16' Ped Diapason	250	2' Diapason
177	Ezra's Burner	214	16' Ped Reed	251	2' Reed
178	Sacrificer	215	16' Reed A	252	2' Gamba
179	Gimme Some	216	16' Reed B	253	2' DiaCeleste
180	Mean Bean	217	16' Gamba	254	2' Ballpark Stop
181	JL's DirtBomb	218	16' DiaCeleste	255	2' Viol
182	SputtringingB3	219	16' Ballpark Sto	1089	888800000
183	Room B	220	16' Viol	1090	888800008
184	MusselShoalsB3	221	8' Open Flute	1091	866800000
185	Brother Jack	222	8' Stop Flute	1092	888000000 Oct +1
186	My Sunday	223	8' Diapason	1093	848600046
187	Dew Dropper	224	8' Ped Bourdon	1094	850005000 Oct +1
188	J's Comper	225	8' Reed	1095	884400000
189	Fisher's VAST B3	226	8' Gamba	1096	888660000
190	OrganWaveComper	227	8' DiaCeleste	1097	808808008 Tri
191	VAST1-3 Ch/Perc	228	8' Ballpark Stop	1098	888800088 Tri
192	VAST-ly Organ	229	8' Viol		
193	VAST Bars	230	5 1/3' Ped Bourd	STRINGS	
194	Firebreather C3	231	4' Open Flute	256	Studio A Strings
195	XtremTubeB3Perc	232	4' Stop Flute	257	NashvilleStrings
196	Wah B3+Echo	233	4' Diapason	258	Tender Strings
197	Fooled Again Org	234	4' Ped Bourdon	259	Vienna Octaves
198	Phase sw Organ	235	4' Reed	260	Espressivo Lead
199	Combo Rotary	236	4' Gamba	261	Dulcet Strings
200	Far Draws	237	4' DiaCeleste	262	Big LA Strings
201	D-Vox Organ	238	4' Ballpark Stop	263	Touch Thick Mix
202	Indagardenoveden	239	4' Viol	264	DarkNYCStudio
203	Animals Organ	240	2 2/3' OpenFlute	265	StringMachine
204	Chapel Organ	241	2 2/3' StopFl 12	266	VerySloVeryThick
205	Soft Stops	242	2 2/3' Diapason	267	SloMuted Strings
206	Pipe Stops	243	2 2/3' Reed	268	Solemn Strings

Programs

269	SloStr Prs Swell	306	Adagio Octaves	343	AgressTutti Mix
270	Keyboard Strings	307	Adagio Tremolo	344	AgressDivisiMix
271	TripleStrike Str	308	AdagioPizz Split	345	Agresso Violins
272	Processed Strgs	309	Adagio Split	346	AgressoViolinsII
273	Punchy Strings	310	Adagio Bs/Vln I	347	AgressoViolinDiv
274	Fast Strings	311	AdagioTremSplit	348	Agresso Viola
275	London Spiccato	312	Fast Divisi Mix	349	AgressoViolaDiv
276	EspressivoViolas	313	Fast Divisi Str	350	Agresso Cello
277	Rigby's Strings	314	Fast Tutti Mix	351	AgressoCelloDiv
278	Weeping Strings	315	Fast Mix Octaves	352	Agresso Bassi
279	Buzzy Strings	316	Fast Divisi 8ves	353	AgressoBassiDiv
280	Slow Thick Mix	317	Rite of Strings	354	Agresso Tremolo
281	Pan Strings	318	Fast Violins I	355	Agrs lo/Trem hi
282	LoFi Studio Str	319	Fast Violins II	356	AgresTrem 8ves
283	Marmalade Stgs	320	Fast Violins Div	357	AgressoHalfTrem
284	Bass & Violins	321	Fast Viola	358	Marcato Divisi
285	Proper Pizzicato	322	Fast Viola Div	359	Marcato Mix 1
286	Full Pizzicato	323	Fast Cello	360	Marcato Mix 2
287	Touch Full Pizz	324	Fast Cello Div	361	Marcato Mix 3
288	Variable Pizz	325	Fast Bassi	362	Marcato PrsTrem
289	Arco Strings	326	Fast Bassi Div	363	SloStr Prs Trem
290	PizzBass/ArcoLead	327	Fast Tremolo	364	Sfz Prs Trem
291	Adagio Strings	328	Fast Tremolandi	365	Lead & Adagio
292	Adagio Divisi St	329	Legato Violins I	366	Lead & 8vaAdagio
293	AdagioDivisi Mix	330	Legato Violins II	367	Lead Tutti Mix
294	Adagio Tutti Mix	331	Legato ViolinDiv	368	Lead Strings
295	AdagioDiv 8ves	332	Legato Violas	369	Lead Divisi Str
296	AdagioTutti 8ves	333	Legato Viola Div	370	Lead Divisi Mix
297	Adagio Violins I	334	Legato Celli	371	LeadTuttiMix B
298	Adagio ViolinsII	335	Legato Celli Div	372	Lead Strings Split
299	AdagioViolin Div	336	Legato Bassi	373	Lead MixOctvs
300	Adagio Violas	337	Legato Bassi Div	374	Lead Upper Range
301	AdagioViolas Div	338	Legato Tremolo	375	Lead Div 8ves
302	Adagio Celli	339	Tutti Strings	376	Lead Violins I
303	Adagio Celli Div	340	Divisi Mix +solo	377	Lead Violins II
304	Adagio Bassi	341	Agresso Strings	378	Lead Violins Div
305	Adagio Bass Div	342	AgressDivisiStr	379	Lead Violas

380	Lead Violas Div	417	Adagio Magic	447	Undercurrents
381	Lead Celli	1084	Hybrid Solo Strg	448	Shimmer Pad
382	Lead Celli Div	1085	Hybrid Cello	449	Anesthesia
383	Lead Bassi	1086	FM Hard Bowed	450	Harpolicious
384	Lead Bassi Div	1087	FM Bowed Synth	451	Pedal Pad
385	Lead Tremolo	1088	Cotton Strings	452	Square Pad
386	Solo Violin fast			453	Water Buffalo
387	Solo Viola fast	PAD		454	Blue Resonance
388	Solo Viola slow	418	Evolving Pad	455	Ethereal Joe
389	Solo Cello fast	419	Evolving Pad 2	456	Sparkly Pad
390	Solo Cello slow	420	Gleam Dream	457	Cycling Pad
391	More Viola	421	Vox Bed	458	TrickleDownPad
392	Dual UpperDivisi	422	Synbrass Pillow	459	Hi Vox Cloud
393	Dual Upper tutti	423	Innervate	460	Swell & Hold
394	Dual Slow Split	424	Deep Sweep	461	Heaven & Earth
395	Dual Half Trem	425	UFO Pad	462	Slo QuadraPad
396	Largo Mix	426	Tronesque	463	Le Pesque
397	Largo Mix 2	427	Cosmic Sus Pedal	464	Wispy One
398	Largo conSordino	428	Murky Rez Pad	465	Fairlight Pad
399	Largo 8ves	429	Omni Evolver	466	So Lush Pad
400	Power Trem Strgs	430	4Pole Pad	467	Add a Pad 1
401	OversizedQuartet	431	Movie FX	468	Add a Pad 2
402	Folk Violin slow	432	KnowWhatIMean	469	Lush Pad
403	WheelBowViola	433	Warm Sliders	470	Deeper Water
404	WheelBowBass	434	Musical Spheres	471	Deep Vox Bed
405	WheelBow Fiddle	435	Film Score Pad	472	Slo Syn Orch
406	WheelBow Cello	436	Nitrous Pad	473	SubtlePad+EGrand
407	Electric Bow	437	Res Pad	474	5th-Scape
408	Modwhl Remix Str	438	Triangle Drone	475	Warm Encounter
409	Yesesis Tron Str	439	Slow Rhythm Pad	476	Ancient Calling
410	Trontable	440	Pan Motion Pad	477	Hi Res StringPad
411	Octave Tron Str	441	BPM BionicStrngs	478	AutoRes StrPad
412	Strange Space	442	BPM Echo Pad	479	Omni Strings
413	ELO Strings	443	Tremolo Flange	480	SEM Strings
414	BritishMT String	444	Arpeggi Pad	481	Giallo SynStr
415	RocknRollSuicide	445	FX Sweep	482	St Pan Phase
416	LightYearStrings	446	Twilight Pad	1073	Se7en Pad

Programs

1077	Calisto Pad	513	Vintage Wobbler	550	Cloud Level
1078	Cyclotron Pad	514	Quadra Comp	551	Square Bell
1079	FM Live Pad	515	Synth Preset 1	552	Poly VeKtor
1082	Dark & Slow	516	Plastic SoulSyn	553	Dearly Beloved
1130	Fridgid Pad	517	Wet as it Gets	554	PBS on VHS
		518	Mayhem Wheel	555	WheelMangler
		519	Ion Drive	556	PWM Synth
	SYNTH	520	NewOrderPulses	557	Last Challenge
483	Classic Saws	521	Punch Synth	558	Granny
484	80s Lead Synth	522	Super Saw Stabs	559	Dark Wobbles
485	Fat Syn Orch	523	Attack Trance	560	DownwardSpiralMW
486	Poly Sweep	524	Frozen Sawdust	561	Poly Arpeggiator
487	D'tuned Polysyn	525	GatedSqrSweepBPM	562	Cosmic Intervals
488	AM SquareSynth	526	Tesla Coil	563	MW S&H Filt
489	Prophesied Six	527	Armin a Leg	564	ElectroPercSynth
490	Anabrass	528	VASprSaw+Allpass	565	HiPassMWhlBlips
491	Poly Brassy	529	VASprSaw	566	Pattern Machine
492	PolyPitch Brass	530	VA1 Detuned Saws	567	VA1 Stage Lead
493	NastySynBrass	531	VA1 DetunedPulse	568	VA1 Saw Lead
494	SynBrass Comper	532	VA1 Detuned Sqrs	569	VA Square Lead
495	Jump! Obx	533	VA1DstPulseWheel	570	VA1Distlead CC
496	Big Old Jupy	534	ModwheelKotoSyn	571	4PoleV Lead
497	80s Saws	535	Chirp Attacks	572	Snap Lead
498	MeanStereoSweep	536	Popcorn	573	Wheel Growl
499	Divider	537	Clone Bandit	574	Mono Trekkies FX
500	Filter Sweep Pad	538	Plantasia	575	Minipulse 4Pole
501	Touch Trance	539	WheelSyncBlips	576	Dist Filter Lead
502	Throaty S&H	540	Snappy Synth	577	4 Pole Lead
503	Chillwave Chords	541	Dist Perc Bass	578	Squeeze Lead
504	Panning Synth	542	Radio Googoo	579	Saw+Mogue 4Pole
505	SyncSqr Template	543	Osti-Warble	580	C*O SyncLead
506	Funkensteinz'AHP	544	Boinker	581	12SAWMWheelLead
507	St Pan Phase	545	Percolator Glow	582	Bocuma
508	Hot Filter	546	Perc Arp Synth	583	MwhlClubsweeper
509	All My Love Strg	547	80s #1	584	ChmBrsBassLead
510	Mesosphere Pad	548	Static Charge	585	The PhattestLead
511	Wavetable Pad	549	T's Tomato	586	5ths Lead MP
512	CarpenterSndtrck				

587	Woodhouse Lead	624	Mini-Obi Bass	1050	Strange Mallet
588	MeanWahMono	625	RideTheMWBass	1051	Bell & Pad
589	2 Hand Tap Lead	626	Ring Env Bass	1055	Opium Keys
590	Keytar Hero(Wah)	627	9 1/2 Yard Bass	1056	Hard Detuned
591	Robin's Lead	628	The PhattestBass	1057	Hybrid Blow
592	Treble FM Lead	629	Aggro OctoBass	1058	Nickel Floot
593	Delicate FM Lead	630	MiniFunk Bass	1059	Noisy Bottle
594	E-Bow Mono	631	Dread Bass	1072	FM Warm SynBrass
595	Brassy Lead	632	Skool Bass	1074	Vintage FM Vox
596	Chirp Lead	633	Alias Bass	1075	Ping Vox
597	Square Lead	634	Vel Filter Bass	1076	Dual Linear Vox
598	Seongdeok Lead	635	Smooth Oooger	1080	Delayed Partial
599	Soy Incident	636	ARPesque Bass	1081	Moving FM Engine
600	AK Wild Lead	637	Leviathan Bass	1083	Creaking Pad
601	Downes Lead	638	Squeeze Mini	1099	Harmo Lead
602	80s Lead Synth	639	KneeDeep Mini	1100	Edge Lead
603	MW Lead	640	DistBass Solo	1101	Dyna Roller
604	MicroSynth Plus	641	Rave Bass	1102	Hammer Lead 5th
605	Liquid T Lead	642	1999	1103	Dirty Pluck Lead
606	Fitty-Fitty	643	Krafty Monks MW	1104	Monster FM Sync
607	Toot Lead	644	80s #4	1105	Sync Sqr FM Lead
608	HipHop Lead	645	Perc Bass	1106	6581 Sid Tech
609	Dogs Lead	646	Snappy Bass	1107	Dual Core Synth
610	BPM Lead	647	Iceman Bass	1108	Unison Stack
611	The Way It Is	648	Rhythms	1110	FB Mono Bass
612	Thomas Bass	649	Uptown Bass	1111	FM Classic Bass
613	Poppit SynBass	650	Dub Wob	1112	RM+FM FingerBass
614	Classic Mini	651	APG-ish Bass	1113	SH Type Bass
615	BowhSaw Bass	652	Deception Bass	1114	Octave Bass
616	ANGRYBass	1042	FM Comp Synth	1115	Wooden Bass
617	Lowdown Bass	1043	X-FM Rich Keys	1116	FM Saw/Sqr Bass
618	MWhIMayhemBass	1044	Bright Digi-Perc	1117	Filtered FM Bass
619	MaroonSynBass	1045	Low Digital Vox	1118	Growl FM Bass
620	Dist Filter Bass	1046	Sharp & Shaped	1119	Diamond Bass
621	SAW Press-Rez	1047	Da Pincher	1120	Noisy Snap Bass
622	Envy Bass	1048	Duck Tape Vox	1121	FM Pulse Bass
623	Woodhouse Bass	1049	Woody Thing	1123	Minor Impact

Programs

1124	Cyclic Modulator	677	Lead FrenchHorn	714	Full Blown
1125	Hollow FM Sqrs	678	Triumphant Horns	715	Bari Hits
1126	Ultra Waves	679	Dyn Bari Horns	716	Tenor Express
1127	1Alg=3PartsJam	680	Bari Horn Section	717	Solo Tenor Sax
1128	3 Hybrid FM Osc	681	Solo Tuba	718	Solo Bari Sax
1129	CC FM Mayhem	682	Dyn Orch Tuba	719	Sax,Horns,MuteTrp
1131	Grindin'Operator	683	Woodwind Section	720	SaxSplits+Flute
1132	Mysterious Clang	684	Ensemble WWinds	721	Ocarina
1133	FM Gone Wild FX	685	BassClar/Clar/Fl	722	Penny Whistle
1134	Backdraft	686	Solo Flute	1033	FM Brass Templ
1135	Murmuring Waves	687	Fast Orch Flute	1060	Soft Brass&Lead
BRASS/WIND		688	Tremolo Flute	1061	Hybrid Troopet
653	1-Note PowerRiff	689	AcidJazzFlute	1062	Hybrid Alto Sax
654	MiamiBrassSects	690	Fruity Floot	1063	Hybrid Bones
655	Lucid Brass	691	MellowT Flutes	1064	Solo Tenor Sax
656	Brass Fanfare	692	StrawberryFlutes	1065	Full FM Brass
657	Fast Orch Brass	693	Piccolo	1066	Bright FM Brass
658	Epic Low Brass	694	Solo Oboe	1067	Detuned Brass
659	Low Brass Chorale	695	Slow Oboe	1068	Trumpets Section
660	Low Orch Brass	696	Fast Orch Oboe	1069	Muted Trumpet
661	High-End Horns	697	Lead Oboe	1070	Solo Brass
662	Sergeant P Brass	698	Clarinet	1071	Hybrid Synbrass
663	Bull Brass	699	Slo OrchClarinet	ENSEMBLE	
664	Almost Muted	700	Fast Orch Clar	723	VivaldiOrchestra
665	Dr. StAb'N SwEll	701	Lead Clarinet	724	HeroicFilmScore
666	Classic SynBrass	702	Clarinet/Flute	725	Gothic Climax
667	Lead Trumpet	703	Solo Bassoon	726	Full Fellowship
668	Two Lead Trumpets	704	Solo Bassoon vib	727	Trumpet Voluntary
669	Soft Trumpet	705	Solo Eng Horn	728	String Continuo
670	Slow Soft Trp	706	Lead English Horn	729	Lullaby Ensemble
671	Dyn Orch Trumpets	707	Fast Orch EngHrn	730	Tutti Orchestra
672	Trombone Section	708	Slow EngHorn prs	731	Final Victory
673	Dyn Orch Bones	709	Solo Dbl Reeds	732	BattleSceneOrch
674	Solo Trombone	710	Bassoon&Oboe	733	Imperial Army
675	Solo Trbn/Trpt	711	Sylvan Dbl Reeds	734	William Tell A
676	Dyn French Horns	712	BClar/Clar/Flute	735	William Tell B
		713	Sax Section		

736	TripleStrikeOrch	773	Gypsy Reggae	808	JetSet Martini
737	Many Characters	774	Dave & David	809	Cirque du Synth
738	Horns,Winds&Str			810	Armonica Reed EP
739	More Brass & Str	HYBRID		GUITAR/BASS	
740	Winds, Horn & Str	775	AlphaCentauri	811	Fluid E Gtr
741	HornSect Layer	776	Panorama	812	WarmStradaGtr
742	Strings & Winds	777	Ambience	813	Comp'd Phaser
743	Vox & Strings	778	Ambience2	814	DoubleCleanChrs
744	Denouncement	779	Dream Dulce	815	Rob's Caster
745	Pastoral Clr Flt	780	MagicChinaFlower	816	Twin Peaks
746	Pastoral Orch	781	Singapore Sling	817	Voxxed Elec 12
747	Pastoral Pizzi	782	Metal Vibe Pulse	818	New Beauty
748	Pastoral DbIRds	783	Mixed Strummah	819	TremBucker
749	Fast Winds & Str	784	ChirpingStompbox	820	Simple Mutes
750	Fast Winds & Piz	785	Warbly Pong SQR	821	Les Grit
751	Winds&EspressStr	786	Oody Oody	822	Kinda Krunchy
752	Slow Interlude	787	Carpet Babies	823	Chunky Vintage
753	LayeredStrgsWnds	788	Yucatan Vibe	824	Stompbox Les
754	Strings/ClarOboe	789	CelesteGlockHarp	825	TimeWarpCaster
755	Cello & Reeds	790	Old & Warbly	826	ShredfestLead1
756	Fast Str & Perc	791	Metallic Piano	827	MediumCrunchLead
757	Perc Atk Strings	792	Dream Session	828	Nasty'70s Guitar
758	Pizz & Perc	793	3waySplit Mtron	829	Dist Comper
759	Bartok Ensemble	794	Heroes Pad	830	Falgor's Lament
760	Broadway Backup	795	Trick of th'Tail	831	SuperflyWahCast
761	Orch w/ Bells On	796	Siberian Khatru	832	Noisy Feedbacker
762	Poltergeist Trem	797	Warszawa	833	Steel String
763	Reeds & Bells	798	Mello Layers	834	Bling 6 String
764	Strings & Silver	799	Post Rock	835	Boutique 6 Str
765	SugarPlumFairies	800	Pressure Cooker	836	Boutique 12 Str
766	LH Timp Roll Orch	801	Touch Vocoder	837	Real Nylon
767	Fifes & Drums	802	Analog Sparkle	838	Mandolin Plus
768	Matadores	803	Synthy 73	839	Mandolinese
769	New Music Ens	804	Pizzynth	840	ShortStrumma
770	SuperHeroRevenge	805	Wurzzicato	841	Banjo Plus
771	RequiemMassEns	806	BrimstonCalliop	842	Mandolin&BanjoSW
772	WhiteSatinSplit	807	DigitalFairyDust		

Programs

843	Dulcimer	876	Wooly Pckt Kit	913	Rhythm Ring
844	Dulciliere	877	Ornge Crush Kit	914	Gaddy Gruv
845	E-Bass	878	Abe Junior Kit	915	5Kits&Cheez
846	Finger Bass	879	Low Rock Kit	916	Ziga Funk
847	P-Bass	880	Static Kit	917	ElectroBeat Kit
848	70s/'90s Bass	881	Finessence Kit	918	Are'M I ElecKit
849	MT Dark Bass	882	Cold Cash Kit	919	VABassDrmSliders
850	MT Bright Bass	883	Trash Funk Kit	920	VASnreDrmSliders
851	Sly's Bass	884	DoorKnocker Kit	921	VAHi-HatSliders
852	JP's Fretless	885	Rhythmcon Kit	922	Essential Perc
853	Jordan Eb Fretls	886	Marley Kit	923	Perc Accessory
854	Tony's Fretless	887	Superfly Kit	924	Just Jammin'
855	Squire's Rick	888	ScratchMe Kit	925	Cage's Ensemble
856	Beasties Bass	889	DJ- Dub Kit	926	Modern Blockery
857	Acoustic Bass	890	Touch Tone Kit	927	Perc & Blocks
858	Upright Growler	891	Radio Echo Kit	928	Bendir
859	Washtub Bass	892	SoftCookie Kit	929	Bodhran
1034	FM Bass Templ	893	Cannibal Kit	930	DumbekDjembe
1109	OD Caster Guitar	894	Backsweep Kit	931	TalkingDrum
		895	Elektro Sand Kit	932	BongoConga
		896	Big Woosh Kit	933	Tabla Arp
		897	HipgigJunior Kit	934	Basic Orch Perc
		898	L'tric Nat Kit	935	Orchestral Perc
		899	Vibra Lunch Kit	936	Solo Timpani
		900	Tuna Slap Kit	937	Orch Timpani
		901	Shrugie Kit	938	Timp & Aux Perc
		902	Wet Sponge Kit	939	Tam/Cym/BD/Timp
		903	Bug Zapper Kit	940	Climax Perc
		904	Sandy Bott'm Kit	941	Cymbal Roll Tr
		905	Box o' Sand Kit	942	Stereo Tam-tam
		906	L'trk Reflux Kit	943	Chimes/Glock
		907	Squash Clap Kit	944	Chimes
		908	Phase "E" Kit	945	Chime Bell
		909	Why Not Kit	946	Bells Across
		910	Hello Brooklyn	947	Bell Orchestra
		911	BeatBoxDist	948	Carillon
		912	Rezo-King	949	Celeste
DRUM/PERC					
860	Los Angeles Kit	897	HipgigJunior Kit	934	Basic Orch Perc
861	East Space Kit	898	L'tric Nat Kit	935	Orchestral Perc
862	Ring-tone Kit	899	Vibra Lunch Kit	936	Solo Timpani
863	Drum&Bass Kit	900	Tuna Slap Kit	937	Orch Timpani
864	Full Room Kit	901	Shrugie Kit	938	Timp & Aux Perc
865	Copper Ring Kit	902	Wet Sponge Kit	939	Tam/Cym/BD/Timp
866	Birch Wood Kit	903	Bug Zapper Kit	940	Climax Perc
867	25th Anniv Kit	904	Sandy Bott'm Kit	941	Cymbal Roll Tr
868	ModernRok Kit	905	Box o' Sand Kit	942	Stereo Tam-tam
869	Fin-Essence Kit	906	L'trk Reflux Kit	943	Chimes/Glock
870	Procs'd Pop Kit	907	Squash Clap Kit	944	Chimes
871	80's Power Kit	908	Phase "E" Kit	945	Chime Bell
872	Brushes Kit	909	Why Not Kit	946	Bells Across
873	BrushStroke Kit	910	Hello Brooklyn	947	Bell Orchestra
874	Old Traps	911	BeatBoxDist	948	Carillon
875	Pillow Fuz Kit	912	Rezo-King	949	Celeste

Appendix D

Multis

Object Version 1.00.24

1	Piano/AC Bass	26	Pad/Synth 6	2044	Split Default
2	Piano/Elec Bass	27	String/Voice 1	2045	Layer Default
3	Piano/Frtls Bass	28	String/Voice 2	2046	PC4 Control
4	Piano/Synth Bass	29	String/Voice 3	2047	Clear Multi
5	E. Piano/AC Bass	30	String/Voice 4		
6	E. Piano/E. Bass	31	String/Voice 5		
7	E. Piano/Fr.Bass	32	String/Voice 6		
8	E. Piano/SynBass	33	Upright Bs/Organ		
9	E. Piano/SlpBass	34	E.Bass/Organ		
10	Synbass/Synth	35	Frtls.Bass/Organ		
11	Synbass/Synth 2	36	Syn Bass/Organ		
12	Synbass/Synth 3	37	Organ/Piano Splt		
13	E. Bass/Synth	38	Organ/E.Piano Sp		
14	Frtl. Bass/Synth	39	Organ/Piano Lyr		
15	SynPad/Lead 1	40	Organ/EPiano Lyr		
16	SynPad/Lead 2	41	Ac.Guitar/Pad		
17	SynPad/Lead 3	42	Elec.Guitar/Pad		
18	Synth/Lead 1	43	Dulciliere/Pad		
19	Synth/Lead 2	44	Orchestra/Pad		
20	Synth/Lead 3	45	Vibes/Pad		
21	Pad/Synth 1	46	Vox/Strings/Pad		
22	Pad/Synth 2	47	Vibe/Pizz/Perc		
23	Pad/Synth 3	48	Dream Layer		
24	Pad/Synth 4	49	Tron		
25	Pad/Synth 5	50	Clav/Harpsichord		

Index

A

Add parameter 7-26.
 Add Parameter 7-18.
 Advanced
 Use of KVA oscillators 3-77.
 Aftertouch. *See* Mono Pressure.
 Algorithm 3-50, 3-52.
 Alphanumeric Entry 7-8.
 Arpeggiator 3-22.
 Arp Mode 3-23.
 Preset 3-23.
 Audio Cables 10-3.
 Audio Out S/M 9-8.
 Audio Problems 10-3.
 Auto Power Off 9-4.
 Aux 1 3-14.
 AUX1 Override 7-28.
 Aux1 Parameter 7-28.
 Aux 2 3-14.
 AUX2 Override 7-28.
 Aux2 Parameter 7-28.
 Aux FX Channel 7-28.

B

Bank
 Change 7-7, 7-20, 7-21. *See* MIDI: Bank Changes.
 MIDI 7-7, 7-8, 7-20, 7-21.
 Mode 7-7, 9-24.
 Select 9-24.
 BankMode Parameter 7-7.
 Banks
 Shift Patterns 7-24.
 B Audio Output 9-8.
 Bend 7-22, A-1.
 Bend Down Ct 7-8.
 Bend Down ST 7-8.
 BendRange Down Parameter 3-17.
 BendRange Up Parameter 3-17.
 Bend Up Ct 7-8.

Bend Up ST 7-8.
 Brightness 10-2.
 Bump 7-10, 7-18.
 Buttons
 Double Press
 Panic 2-9, 10-4.
 Program Demo 1-16.

C

Cascade Mode 3-77.
 Category 3-17.
 CATEGORY Buttons 1-6.
 Category Default. *See* Default (Category).
 CC Jack 1-2.
 CC number 3-11.
 CC (VOLUME) Jack 1-10.
 Chain 4-5, 4-6, 7-28.
 Chain Info 4-6 to 4-7.
 Change Multis Parameter 9-24.
 Channel 2-9, 7-7, 7-22, 10-5, 9-25, A-1.
 CHANNEL/PAGE Buttons 1-8.
 Channel Parameter 7-7.
 Chorus 4-16.
 Clock Source 9-26.
 Common Page 7-40.
 COMMON page
 KB3 3-109.
 Common Problems 10-1.
 Compatible Files 9-21.
 Compress 7-10, 7-18.
 Compression 4-15.
 Connecting Pedals 6.
 Continuous Controllers 7-16.
 Continuous Switch Pedals (Half-Damper) 1-10.
 Contrast Knob 10-2, B-1.
 Control 3-7.
 Controller 1-2, 2-10, 7-7, 7-8, 7-20, 7-21, 9-24, 7-39, 9-23,
 9-24, A-1.
 Controller Parameter 7-16.
 Controllers
 in Program Mode 2-5.

Index

Crossfade 7-10, 7-18, 3-59.
Curve Parameter 7-18.

D

Delay 3-46, 4-11.
Delete 3-71, 7-43.
Destination 7-6, 9-23.
 Controller 7-20, 7-39.
 Local 7-6, 7-7, 7-22, 7-8, A-1.
 MIDI 7-6.
Destination Parameter 7-6, 7-14, 7-17.
Directories 9-17.
Display 6-2, 10-2.
 Contrast Knob 10-2, B-1.
Display Parameter 9-3.
Distortion 4-20.
Drawbars 3-111.
Drum Remap 9-14, 3-60.
DSP
 DSP Control 3-54.
 DSPMOD 3-56.
Dual Switch Pedals 1-10.

E

EDIT Button 1-8.
Effects B-1.
 parameters 4-9.
Enable 3-47.
Enable Parameter 7-27.
Entry Position Parameter 7-19.
EntryPrgChg Parameter 7-8.
Entry Program Change. *See* Program Change: Entry.
Entry State 7-15.
Entry State Parameter 7-15.
Entry Value 9-8.
Envelopes 3-61 to 3-65, 3-68.
EQ 4-13. *See* Master EQ.
 Page 3-115.
Exit State 7-15.
Exit State Parameter 7-15.
Exit Value Parameter 7-19.
Expand 7-10, 7-18.
Expanders 4-15.
Expression 9-32.

F

Factory 6, B-1.
File Name 9-19.
Files
 Load (Fill) 9-19.
 Loading 7-7, 7-8, 7-15, 9-19.

 Load (Overwrite) 9-19.
 Saving. *See* Store.
FILL 9-19, 9-22.
Filters 4-19.
Flanger 4-17.
Flash Drive. *See* USB Flash Drive.
Freeze Pedal 3-48.
Front Panel , 1-5.
FX. *See* Effects.
 Mod controller 4-6.
FX Mode Parameter 9-2.
FX Page 3-13.
FX Select A-1.

G

Gates 4-16.
General MIDI
 Velocity Map 9-10.
Global Mode 9-1, 9-23.
Global Parameters 7-6.
Globals 3-21.

H

Half Damper Pedal 3-48. *See* Pedal: Half Damper.
Half-Damper Pedal 1-10.
Headphones 1-11.
HELP 4-8.
HiVel Parameter 7-10.

I

ID Numbers 6-9, 2-10, 2-10, 9-25.
Impact 3-65.
Info 1-2, 9-31.
INFO page 4-6.
Insert 3-14.
Int. Key 9-13.
Intonation Key 3-18, 9-13.
Intonation Map 3-17, 9-12.

K

K2600 Bank Mode 7-7.
KB3 Channel 7-40.
Key 5-3.
Key1 Parameter 7-15.
Keyboard 1-2, 7-6, B-1.
 range 3-45.
KeyClick 3-117.
Keymap 3-40.
Keymap Editor 5-1.
Keypad Buttons. *See* Buttons: Keypad.

Key Range Parameter 2-8, 6-8, 7-4.
 Key tracking 3-41.
 Knob 10-2.
 KNOBS 1-7.
 KVA oscillator 3-74, 3-75, 3-77 to 3-81.

L

LaserVerb 4-18.
 Latch 3-24.
 Layer
 Function 6-7.
 Layer FX 3-16, 3-59.
 LCD Display B-1.
 LED 2-10.
 Legato 3-33, 3-42.
 LFO 3-67.
 Rate 3-67.
 Linear 7-10, 7-18.
 Load 9-17. *See also* Files: Loading.
 Page 9-19.
 PC B-1.
 USB 9-4, B-1, 9-23.
 LocalKbdChan 9-25.
 Local Keyboard Channel 9-25.
 Local Program 7-7, 7-8.
 Loop 3-62, 5-12.

M

MAIN1 Page 9-1.
 MAIN2 Page 9-9.
 Main Page 7-5.
 MAIN Page 4-2.
 Maintenance 10-1.
 MIDI 2-3, 6-2, 9-31.
 Bank. *See* Bank: MIDI.
 Bank Change Messages 7-7, 7-8, 7-20, 7-21.
 Channel 2-3, 2-9, B-1. *See also* Channel.
 Channel Transmit 7-7, 10-5, 9-23.
 Implementation Chart A-1.
 Page 9-23.
 Ports 9-23.
 Problems 10-5.
 Program Change 7-7, 7-8, A-1.
 Program Parameter 7-7, 7-8.
 MidiBank Parameter 7-7.
 MidiProg Parameter 7-8.
 Mirror Primary Outputs 9-8.
 Mod Controls 4-1.
 Mode
 Global. *See* Global Mode.
 Multi 2-8, 6-1 to 6-15, 7-13.

 Multi Edit 2-9, 7-1, 10-4.
 Program 2-1 to 2-11.
 MODE Buttons 1-6.
 Mode Parameter 7-14, 7-17.
 MOD Pages 4-3.
 MODULATION WHEEL 1-7.
 Mod Wheel 7-20.
 Momentary 7-14.
 mono 9-32.
 Mono A-1.
 Monopressure 1-2.
 Mono Pressure 7-22, 9-11, B-1, A-1.
 Mono Switch Pedal. *See* SW1; *See* SW2.
 Multi Controllers 9-8.
 Multi Edit Mode 2-9, 6-8, 7-1, 10-4.
 Multis 6-1 to 6-15.
 Deleting. *See* Deleting User Multis.
 Favorites. *See also* Favorite Buttons.
 Parameters List. *See* Zone: Parameters.
 Saving 2-8, 6-8, 6-9.
 Zones. *See* Zone.

N

Naming 2-10, 6-10, 2-11, 6-10, 2-11.
 New Directory 9-19.
 Note Map Parameter 7-5.
 Numeric Entry. *See* Alphanumeric Entry.

O

Objects
 Importing 9-21.
 Loading. *See* Files: Loading.
 Programs. *See* Program.
 Octave 7-25.
 Off Value Parameter 7-15.
 On Value Parameter 7-15.
 Out Pair B Mode 9-8.
 Out Parameter 7-6.
 Output Gain Parameter 3-17.
 Output Parameter 3-14.
 Overview Page 7-3.
 OVWRTE 9-19, 9-22.

P

Pan 7-21, 3-58.
 Panic , 1-16.
 Pan Parameter 2-8, 6-8, 7-4.
 Param 4-3.
 Param/Channel Buttons. *See* Buttons: Param/Channel.
 Parameter 3-6.
 Edit Page 3-9.

Index

Parameter Assignments 7-13.
Parameter Edit 3-9.
PARAMS Page 3-6.
Path 9-17.
PC B-1.
Pedal 1-2, 6, B-1, 1-2.
 freeze 3-48.
Pedal Noise 9-14.
Pedals
 Continuous Controller (CC) Pedal 1-10.
 Dual Switch Pedal 1-10.
 Half-Damper Pedal 1-10.
 in Multi Mode 6-5.
 Switch Pedal 1-9.
Percussion 3-115, 3-116.
Pitch 5-11.
Pitch Bend 3-46.
Pitcher 4-24.
Playback mode 3-43.
Power ii, iii, 9-4, 10-1, 10-2, 6, B-1.
 Problems 10-1.
Power Cable iii.
Power Off 9-4. *See* Auto Power Off.
Pressure. *See* Mono Pressure.
Pressure Map 9-11.
PrgChangeMode Parameter 9-25.
Problems 10-1.
Program 2-1 to 2-11, 2-3.
 Favorites. *See* Favorite Buttons.
 Mode 9-2. *See* Mode: Program.
 Saving 2-10.
Program Change. *See* MIDI: Program Change.
 Entry 7-8.
 Function. *See* Functions: MIDI Program Change.
Program Change Mode 9-25.
Program Demo. *See* Functions: Program Demo.
Program Edit Mode 3-1.
Program Parameter 2-7, 6-7, 7-3.
Programs
 Selecting 2-1.

Q

Quantize 4-17.

R

Rear Panel Connections 1-2.
Reset 9-33.
Restore 6. *See also* Reset.
Restoring Factory Defaults 6.
Reverb 4-10.
Ring Modulation 4-25.
Root 5-11.

RootKey 5-11.
Root Note 7-25.
Rotating Speakers 4-21.
Rubber Feet. *See* Feet (Rubber).
Rvrs Compress 7-10.
Rvrs Crossfade 7-10.
Rvrs Expand 7-10.
Rvrs Linear 7-10.

S

Samples 5-2, 3-41 to 3-66, 3-74, 3-2, 5-4, 5-13.
Save 2-11, 6-8, 6-10. *See* Multis: Saving; *See* Program: Saving; *See* Store.
SAVE Button 1-8.
Saving
 arpeggiator patterns 3-22.
 keymap 5-7.
 samples 5-14.
 user multi 5-1.
Scale Parameter 7-17, 7-26.
Select Directory Dialogue 9-19.
Selecting
 Modes. *See* Mode: Buttons.
 Objects. *See* Objects: Selecting.
Selecting Multis 6-1.
Selecting Programs 2-1.
Service Centers 6.
Shift Key 7-24, 7-25.
Shift Pattern 7-24.
Sliders 1-2, B-1.
Soft 1-2.
Soft Button. *See* Buttons: Soft.
Soft Pedal 7-21.
Software
 Update. *See* System Update.
Song Demo 1-16.
Sostenuto 1-2, 7-21, 6.
Specifications B-1.
Split 2-8, 6-8.
 Function 2-6, 6-6.
STATE 9-32.
Status Parameter 7-3.
Stereo 3-41.
 simulation 4-25.
Store 9-17, 9-18, 9-33.
Support 6.
Sustain 1-2, 7-21, 6.
SW1 (SUSTAIN) and SW2 Jacks 1-9.
Switch Controllers 7-13.
Switch Pedal 1-2, 6, 1-2.
Sync Square 3-76.
Sysex ID 9-25.

System Update B-1.

T

Tap Tempo 1-2.
TAP TEMPO Button 1-8, 6-5.
Tempo Parameter 7-40.
Text soft button 4-6.
Thumb Drive. *See* USB Flash Drive.
Timbre Shift 3-42.
Toggle 3-20, 3-108, 3-116, 9-14.
 soft button 5-3, 5-4.
Toggled 7-14.
TOOLS Page 9-31.
Transpose
 Buttons B-1.
 Xpose parameter 3-41.
TRANSPOSE Buttons 1-7.
Transpose Parameter 7-5, 9-2.
Transpose switches 1-2.
Tremolo 4-23.
Trigger 3-46.
Troubleshooting 10-1.
Tune Parameter 9-2.
Tuning 1-7, A-1.
Type Parameter 7-14.

U

USB MIDI 9-4, 9-23.
USB Port 7-6.
USB Ports 1-9.
User
 Bank 9-22.

V

Value 3-8.
Variation Button 7-21.
VARIATION Button 1-7.
VAST
 Dynamic VAST 3-52.
VelCurve Parameter 7-10.
VelMode Parameter 7-9.
Velocity 7-22, B-1, A-1.
 Tracking 3-41, 3-118.
Velocity Map 9-10.
Velocity Parameter 7-15.
VelOffset Parameter 7-9.
VelScale Parameter 7-9.
Vibrato 4-23.
VOICES 9-32.
Volume 2-8, 7-20, 7-21, 9-32.
Volume Parameter 2-8, 6-7, 7-4.

Z

Zone 10-5, B-1.
 Activating. *See* Activating Zones.
 Muting. *See* Muting Zones.